

ELEMENTS

Wetrooms Solved

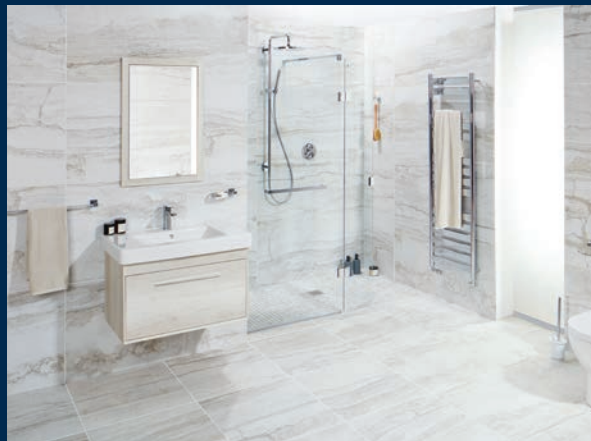

2018





ELEMENTS

Wetrooms Solved









About us...

Established in 1989, Abacus is one of the UK's leading manufacturers and distributors of bathroom and wetroom products.

OUR PRODUCTS

Developed alongside some of the world's most prestigious bathroom brands, our comprehensive product range offers stunning contemporary designs, twinned with market-leading guarantees, which will suit all bathroom needs.

OUR PHILOSOPHY

Our approach to completing a bathroom through both product and design innovations makes us one of the only manufacturers and specialist distributors to supply every product required in a bathroom from conception to completion.

Abacus
Abacus House
Jubilee Court
Coppgrove
Harrogate
HG3 3TB UK

Tel: +44 (0) 345 850 50 40
Fax: +44 (0) 345 850 50 30

Sales:
sales@abacus-bathrooms.co.uk

General enquiries:
enquiries@abacus-bathrooms.co.uk

The most comprehensive wetroom and waterproofing system available in the UK.

Trust

Elements is the ideal product to waterproof and insulate in one operation prior to tiling and offers the most comprehensive waterproofing system available, from a simple bathroom floor to a complete steam room.

Elements not only makes your bathroom last longer, thus protecting your investment, it also reduces mould, making it a much healthier option for any tiling project.

All backed by our 15 year guarantee.*

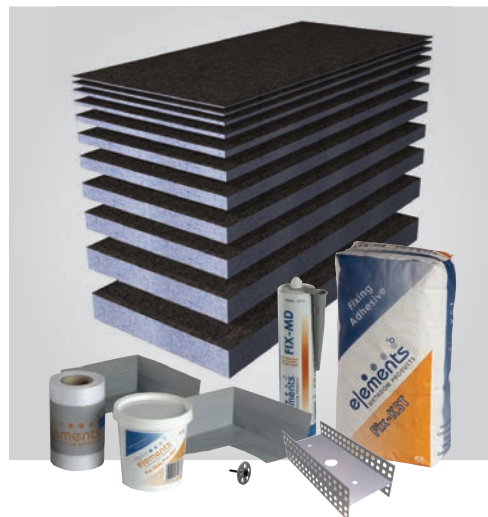

Design

Wetroom shower bases with innovative drain options.

Multi-height wetroom options from floor level to raised tile areas.

Wall and floor building systems for fast and efficient building.

Curved elements and pipe boxings to achieve the perfect look with precision and accuracy.

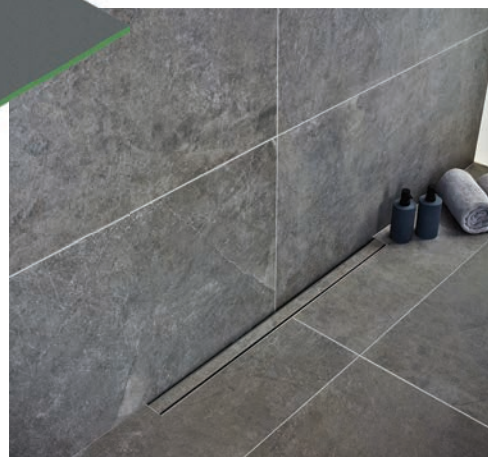
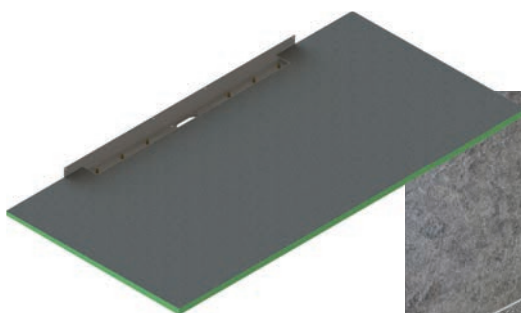

Create

Elements allows you to be creative, making your ideas come to life. From a simple tiled shower seat to a complete steam room.

Innovative pre-fabricated systems.

Elements offers a complete bespoke tailor made service.

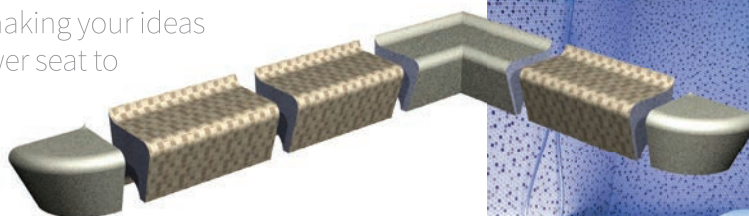

The clever bit is what you don't see...

Elements isn't just about wetrooms, it is a comprehensive waterproofing and insulation system for any bathroom, wetroom or steam room, delivering ultimate build quality 'behind the tiles' for total peace of mind.



Kind to the environment



High compressive strength



Lightweight & easy to handle



Waterproof properties



Insulating properties reducing condensation and energy costs



Easy to cut and shape



Economical construction product



...as well as the bit you do...

Go to our YouTube channel for invaluable help and expertise, presented by top 'skill builder', Roger Bisby

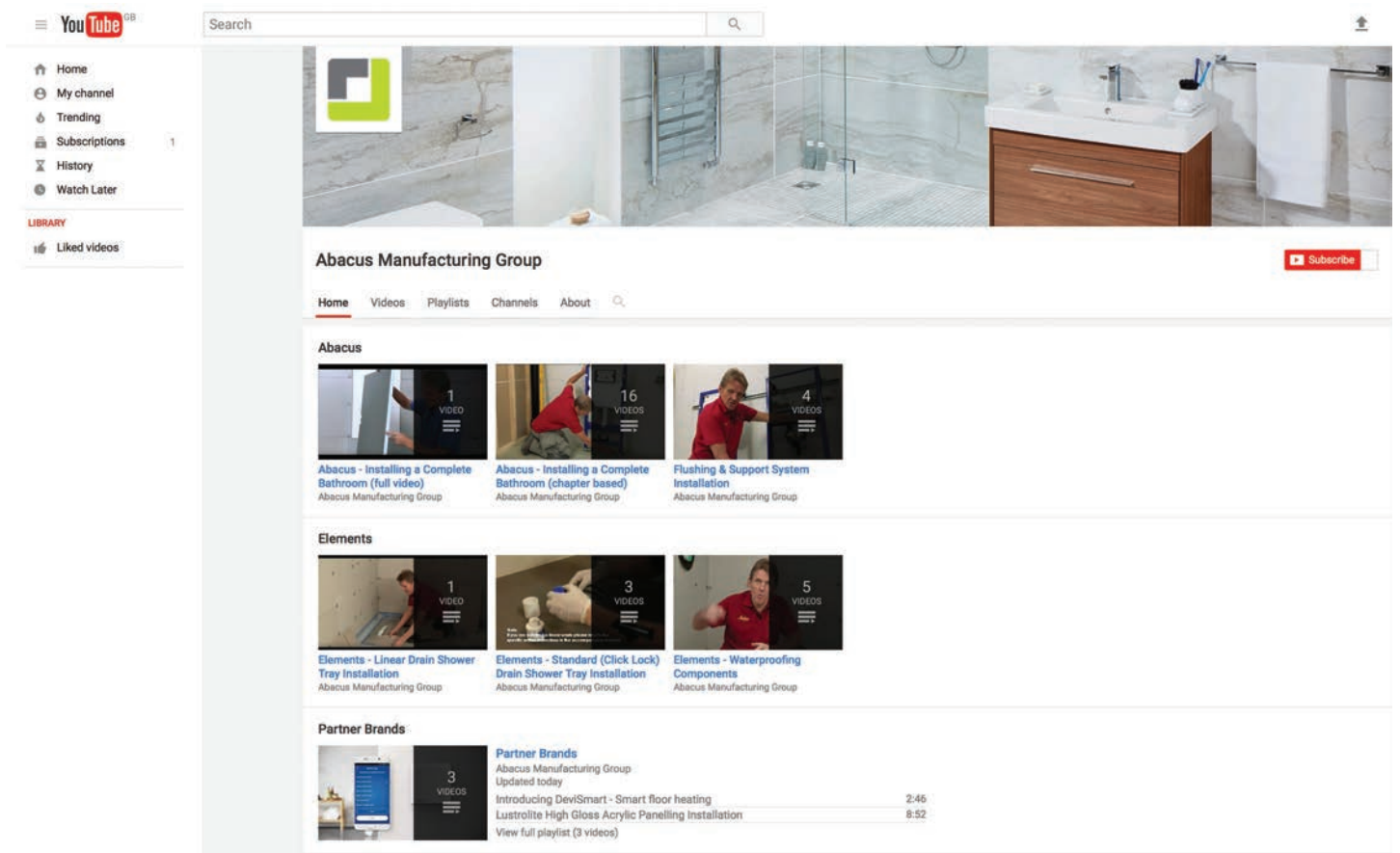

Abacus have teamed up with Roger Bisby to produce a series of best-practice videos enabling our customers to achieve the highest level of build quality in their bathroom installations when using the innovative Abacus product range.

Roger Bisby entered the building industry as an apprentice plumber. He went on to train as a college lecturer and has also run his own building company for nearly 30 years. He specialises in trouble shooting and has a dogged determination to get to the bottom of difficult problems. He put these talents to good use as the regular expert on London Broadcasting Company's (LBC) Fix It Phone in which remained one of their most popular shows throughout its 15 year run.

His television work includes appearances as the resident expert on The Terrace (BBC), Watchdog Home Improvement Series (BBC,) Rogue Traders (BBC) and House of Horrors (ITV). He currently works for trade publications including Professional Builder, Professional Electrician, Professional Heating and Plumbing Installer, and Professional Housebuilder and Property Developer.

Examples of our Elements installation videos include...



- Installing a level access wetroom with a 300mm linear drain

(video length: 13 mins)



- Overboard a floor with 10mm board

(video length: 2.5 mins)



- Top tips for designing a wetroom

(video length: 2 mins)



- Installing a tileable recessed storage box

(video length: 1.5 mins)

...and with many more useful videos online.

Subscribe to our YouTube channel to get the latest updates and new videos as soon as they're uploaded.

Search for Abacus Manufacturing Group – and get the best tips, hints and advice for all aspects of your bathroom or wetroom installation.



The most comprehensive wetroom system on the market, for complete peace of mind and total reassurance of a completely 100% waterproof finished room, all backed with a 15 year guarantee*.

15
YEAR
GUARANTEE

*Guarantee against manufacturing defects, see page 156 for details.

Contents

Raised Showering Concept Kits	16
Level Access Shower Tray Kits	26
Overboard Floor Kits	38
Infinity Single Fall Wetroom System	42
Standard 40mm Shower Trays	46
Level Access 30mm Shower Trays	56
Shower Wastes & Installation Kits	68
Bespoke Shower Trays	70
Elements Components	86
Shower Seats	108
Complete Shower Cubicles	110
Bespoke & Wellness Products	124
Wetroom Glass	128
Bespoke Doors & Panels	152







ELEMENTS

Wetrooms Solved



Raised Showering Concept Kits



RAISED SHOWERING CONCEPT KITS

The Elements Raised Concept Kit allows you to:

- easily achieve that stylish, designer wetroom look where normal floor drainage systems would be difficult to install.
- create a tiled wet area raised above the standard bathroom floor.

The system is lightweight, easy to install and totally flexible in dimensions and drainage types to suit virtually any application. The kits can even be raised to 140mm so that the drain trap does not need to be installed into the floor.

Supplied with high-capacity drain traps of up to 60 litres per minute.

Ideal for bath replacements.

Perfect for apartments or solid floors.

Easy to cut length to exact required size.



HOW TO PURCHASE - 3 EASY STEPS

1. Choose your height

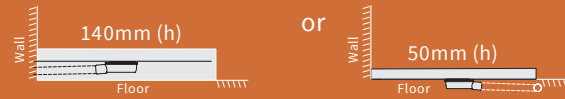

2. Choose your width

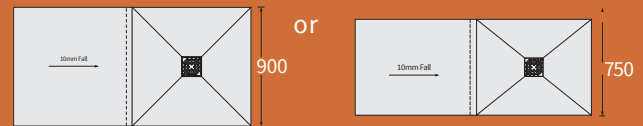

3. Choose your drain type



Complete your wetroom



FOR WETROOM SCREENS SEE PAGES 128-155

Don't forget to consider overboarding your floor. See page 38 for our kit options.



CONCEPT KIT 1 - SQUARE DRAIN

(EMKS-15-1809)

Concept 1 Raised Tray Kit includes complete installation kit
 SIZE (mm): 1850 x 900 x 130/140

The Concept 1 is designed for use where the customer cannot or chooses not to site the drain within the floor. This system is also suitable where longer runs are required for drainage pipework not achievable within the floor, up to 1.5m from the waste to the soil pipe. This typically will be used for apartment buildings or awkward joist locations on timber floors.

£838.00

Note:

- 1) Trays can be reduced in length & width by cutting with a hand saw, however we do not recommend cutting more than 80mm off each side of the tray when reducing the width.
- 2) Tray lengths can be extended by purchasing an additional extension kit.

OPTIONAL:
OVERBOARD
FLOOR KITS
SEE PAGE 38

OPTIONAL:
WATERPROOF
WALL KITS
SEE PAGE 88

INCLUDES



OPTIONAL DESIGNER
DRAIN COVERS
Ask for details

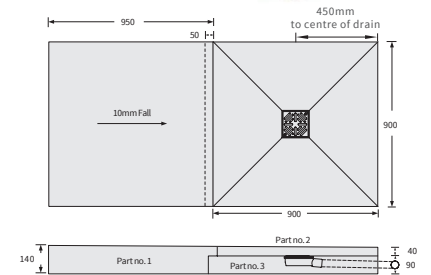
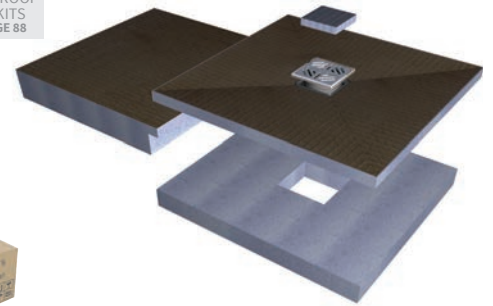

CONCEPT KIT 4 - SQUARE DRAIN

(EMKS-15-1807)

Concept 4 Raised Tray Kit includes complete installation kit
 SIZE (mm): 1850 x 750 x 130/140

The Concept 4 is designed for use where the customer cannot or chooses not to site the drain within the floor. This system is also suitable where longer runs are required for drainage pipework not achievable within the floor, up to 1.5m from the waste to the soil pipe. This typically will be used for apartment buildings or awkward joist locations on timber floors.

£825.00

Note:

- 1) Trays can be reduced in length & width by cutting with a hand saw, however we do not recommend cutting more than 80mm off each side of the tray when reducing the width.
- 2) Tray lengths can be extended by purchasing an additional extension kit.

OPTIONAL:
OVERBOARD
FLOOR KITS
SEE PAGE 38

OPTIONAL:
WATERPROOF
WALL KITS
SEE PAGE 88

INCLUDES



OPTIONAL DESIGNER
DRAIN COVERS
Ask for details

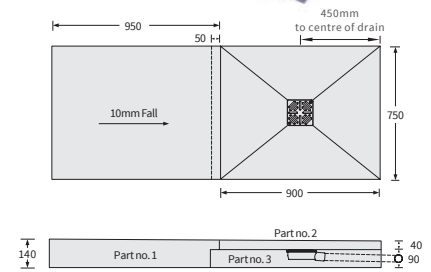
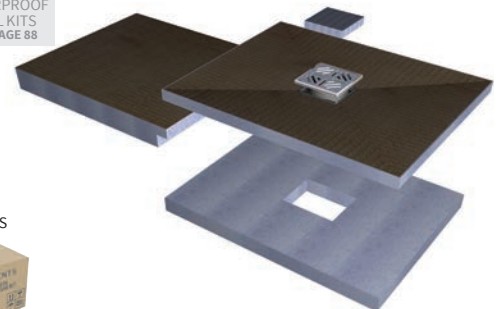

EXTENSION KIT – 900 x 750 x 140mm

(EMAP-40-0505)

140mm Height Extension Kit

Elements extension piece, waterproof tape, FIX-KST, Pro-SEAL extends by 750mm for Kit 1, extends by 900mm for Kit 4

£216.00

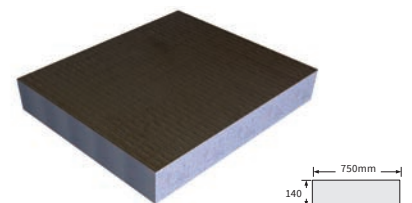



CONCEPT KIT 3 - SQUARE DRAIN

(EMKS-05-1809)

Concept 3 Raised Tray Kit includes complete installation kit

SIZE (mm): 1850 x 900 x 40/50

The Concept 3 kit is designed principally for the replacement of a bath or the creation of a long, low-height shower area. This creates a 40/50mm raised wet area within the bath or shower room.

£724.00

Note:
Trays can be reduced in length & width by cutting with a hand saw, however we do not recommend cutting more than 80mm off each side of the tray when reducing the width.

OPTIONAL:
OVERBOARD
FLOOR KITS
SEE PAGE 38

OPTIONAL:
WATERPROOF
WALL KITS
SEE PAGE 88

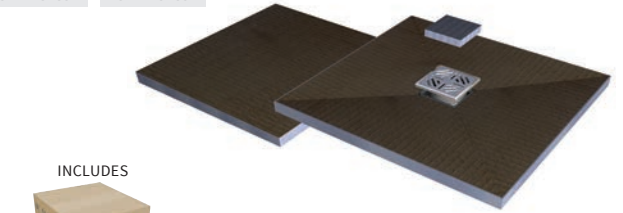

INCLUDES



OPTIONAL DESIGNER
DRAIN COVERS
Ask for details

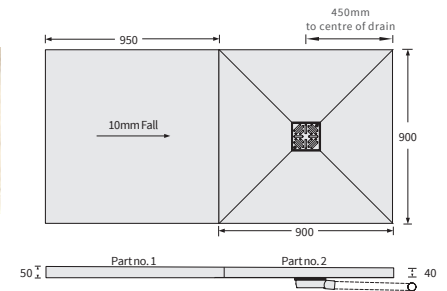

CONCEPT KIT 6 - SQUARE DRAIN

(EMKS-05-1807)

Concept 6 Raised Tray Kit includes complete installation kit

SIZE (mm): 1850 x 750 x 40/50

The Concept 6 kit is designed principally for the replacement of a bath or the creation of a long, low-height shower area. This creates a 40/50mm raised wet area within the bath or shower room.

£699.00

Note:
Trays can be reduced in length & width by cutting with a hand saw, however we do not recommend cutting more than 80mm off each side of the tray when reducing the width.

OPTIONAL:
OVERBOARD
FLOOR KITS
SEE PAGE 38

OPTIONAL:
WATERPROOF
WALL KITS
SEE PAGE 88

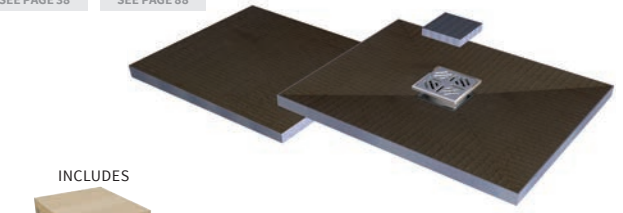

INCLUDES



OPTIONAL DESIGNER
DRAIN COVERS
Ask for details

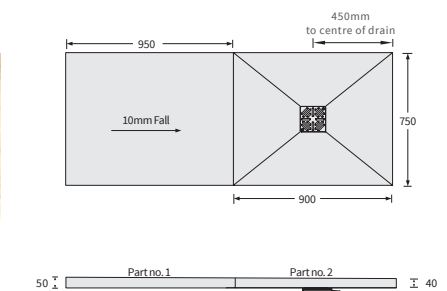



CONCEPT KIT 1L - LINEAR DRAIN 300mm

(EMK3-15-1809)

Linear Concept 1L Raised Tray Kit includes complete installation kit
 SIZE (mm): 1850 x 900 x 130/140

The Concept 1L is designed for use where the customer cannot or chooses not to site the drain within the floor. This system is also suitable where longer runs are required for drainage pipework not achievable within the floor, up to 1.5m from the waste to the soil pipe. This typically will be used for apartment buildings or awkward joist locations on timber floors.

£882.00

Note:

- 1) Trays can be reduced in length & width by cutting with a hand saw, however we do not recommend cutting more than 80mm off each side of the tray when reducing the width.
- 2) Tray lengths can be extended by purchasing an additional extension kit.

OPTIONAL:
OVERBOARD
FLOOR KITS
SEE PAGE 38

OPTIONAL:
WATERPROOF
WALL KITS
SEE PAGE 88

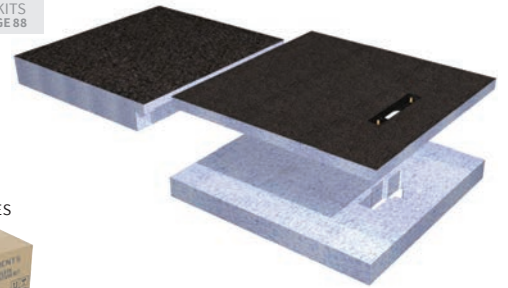

INCLUDES



OPTIONAL TILEABLE
DRAIN COVER
Ask for details

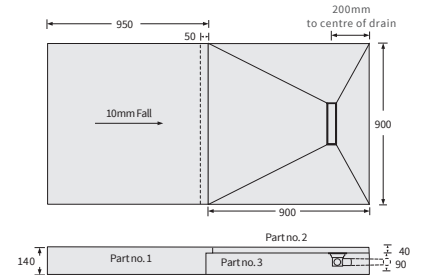

CONCEPT KIT 4L - LINEAR DRAIN 300mm

(EMK3-15-1809)

Linear Concept 4L Raised Tray Kit includes complete installation kit
 SIZE (mm): 1850 x 750 x 130/140

The Concept 4L is designed for use where the customer cannot or chooses not to site the drain within the floor. This system is also suitable where longer runs are required for drainage pipework not achievable within the floor, up to 1.5m from the waste to the soil pipe. This typically will be used for apartment buildings or awkward joist locations on timber floors.

£870.00

Note:

- 1) Trays can be reduced in length & width by cutting with a hand saw, however we do not recommend cutting more than 80mm off each side of the tray when reducing the width.
- 2) Tray lengths can be extended by purchasing an additional extension kit.

OPTIONAL:
OVERBOARD
FLOOR KITS
SEE PAGE 38

OPTIONAL:
WATERPROOF
WALL KITS
SEE PAGE 88

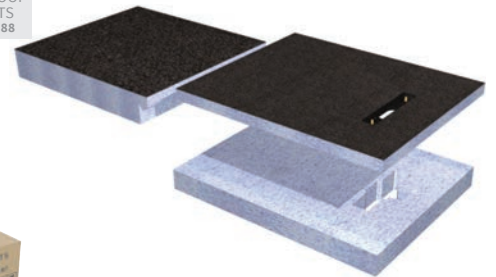

INCLUDES



OPTIONAL TILEABLE
DRAIN COVER
Ask for details

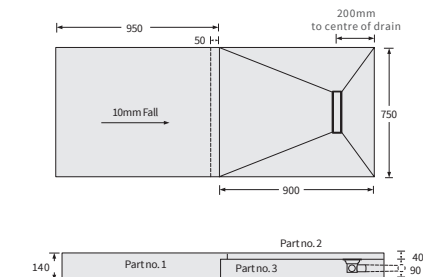

EXTENSION KIT – 900 x 750 x 140mm

(EMAP-40-0505)

140mm Height Extension Kit

Elements extension piece, waterproof tape, FIX-KST, Pro-SEAL extends by 750mm for Kit 1L, extends by 900mm for Kit 4L

£216.00

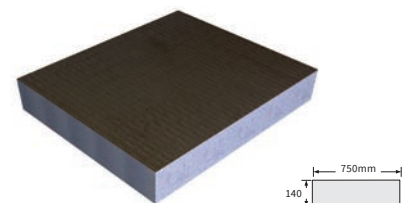



CONCEPT KIT 3L - LINEAR DRAIN 300mm

(EMK3-05-1809)

Linear Concept 3L Raised Tray Kit includes complete installation kit
 SIZE (mm): 1850 x 900 x 40/50

The Concept 3L kit is designed principally for the replacement of a bath or the creation of a long, low-height shower area. This creates a 40/50mm raised wet area within the bath or shower room.

£768.00

Note:
 Trays can be reduced in length & width by cutting with a hand saw, however we do not recommend cutting more than 80mm off each side of the tray when reducing the width.

OPTIONAL:
 OVERBOARD
 FLOOR KITS
 SEE PAGE 38

OPTIONAL:
 WATERPROOF
 WALL KITS
 SEE PAGE 88

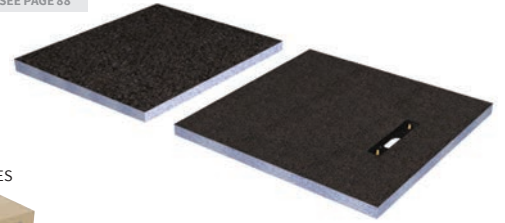

INCLUDES



OPTIONAL TILEABLE
 DRAIN COVER
 Ask for details

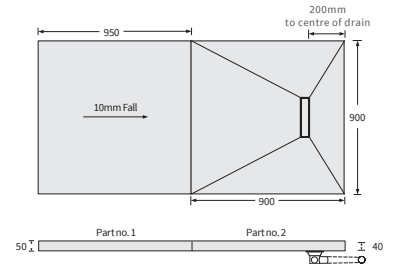

CONCEPT KIT 6L - LINEAR DRAIN 300mm

(EMK3-05-1807)

Linear Concept 6L Raised Tray Kit includes complete installation kit
 SIZE (mm): 1850 x 750 x 40/50

The Concept 6L kit is designed principally for the replacement of a bath or the creation of a long, low-height shower area. This creates a 40/50mm raised wet area within the bath or shower room.

£744.00

Note:
 Trays can be reduced in length & width by cutting with a hand saw, however we do not recommend cutting more than 80mm off each side of the tray when reducing the width.

OPTIONAL:
 OVERBOARD
 FLOOR KITS
 SEE PAGE 38

OPTIONAL:
 WATERPROOF
 WALL KITS
 SEE PAGE 88

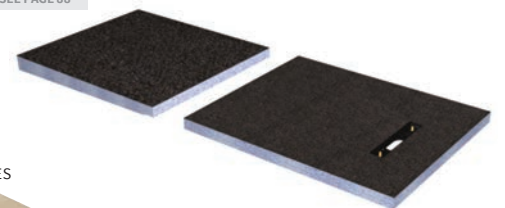

INCLUDES



OPTIONAL TILEABLE
 DRAIN COVER
 Ask for details

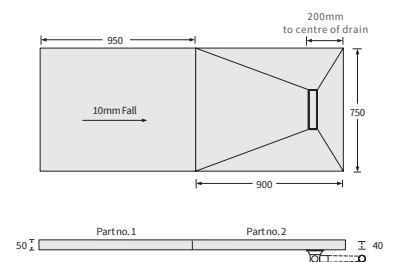

Level Access Shower Tray Kits



LEVEL ACCESS SHOWER TRAY KITS

Specifically designed for the UK market where bathroom floors are overboarded with either plywood or Elements board. These trays are 30mm in height and give a completely flush tiled floor after installation.

If your desired shape or size of shower tray is not included in the standard shower tray range don't worry! Abacus Elements have the ability to make custom shower trays to your design. Virtually any shapes are possible - simply send your requirements to your Abacus Elements dealer.

Supplied with high-capacity drain traps of up to 42 litres per minute.

Ideal for either timber or screeded floors.

A comprehensive range of tray sizes and drain options.

Easy installation.

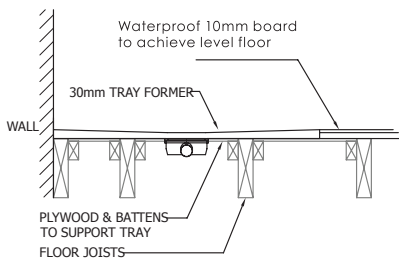

HOW TO PURCHASE - 2 EASY STEPS

1. Choose your shower tray size

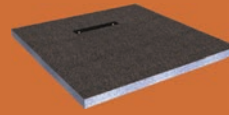

2. Choose your drain type

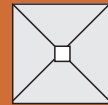

Square

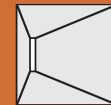

Linear 300

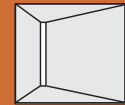

Linear 600

It is recommended to overboard your floor with 10mm Abacus Elements boards.

See page 38 for our kit options.

Complete your wetroom



FOR WETROOM SCREENS SEE PAGES 128-155

Level Access 30mm Shower Tray Kits WITH SQUARE DRAIN

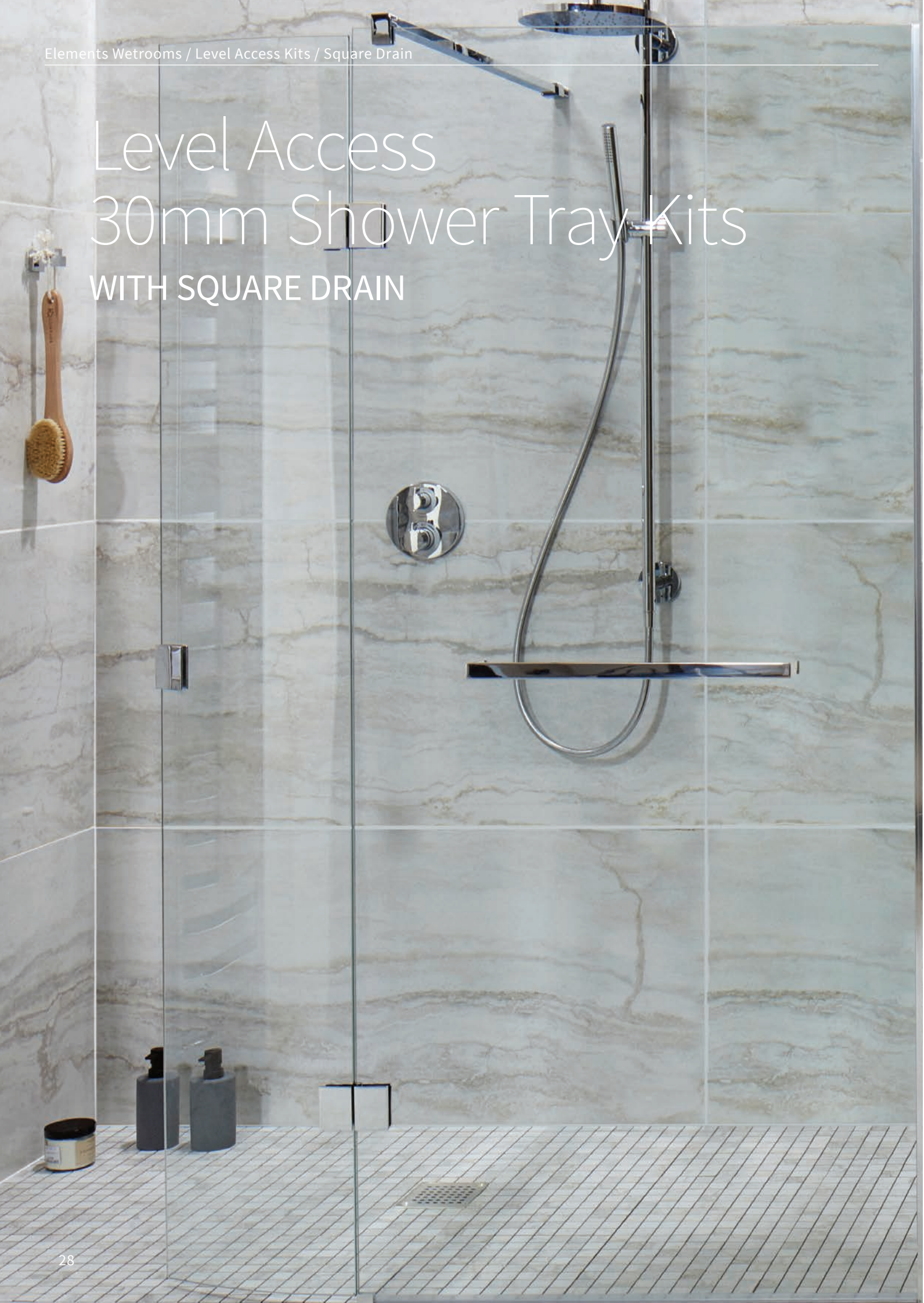

Complete Level Access Shower Tray Kits

All our shower tray kits come complete with a full installation kit

INSTALLATION & DRAINAGE KIT

Installation & Drainage Kit includes:

Pro-SEAL Premix, wood floor primer, horizontal shower waste, Fix-KST, Fix-MD, waterproof tape, waterproof internal corners, tile guide, paint brush, protective gloves, notched trowel



Corner Drain Kits

LEVEL TRAY KIT - 9 x 9 CORNER SQUARE DRAIN

(EMKS-CO-0909)

Level Access Kit Corner Drain

SIZE (mm): 900 x 900 x 30

Includes installation & drainage kit

£549.00



LEVEL TRAY KIT - 10 x 10 CORNER SQUARE DRAIN

(EMKS-CO-1010)

Level Access Kit Corner Drain

SIZE (mm): 1000 x 1000 x 30

Includes installation & drainage kit

£569.00



LEVEL TRAY KIT - 12 x 12 CORNER SQUARE DRAIN

(EMKS-CO-1212)

Level Access Kit Corner Drain

SIZE (mm): 1200 x 1200 x 30

Includes installation & drainage kit

£669.00



End Drain Kits

LEVEL TRAY KIT - 12 x 9 END SQUARE DRAIN (EMKS-EN-1209)

Level Access Kit End Drain
SIZE (mm): 1200 x 900 x 30
Includes installation & drainage kit

£649.00



LEVEL TRAY KIT - 14 x 9 END SQUARE DRAIN (EMKS-EN-1409)

Level Access Kit End Drain
SIZE (mm): 1400 x 900 x 30
Includes installation & drainage kit

£659.00



LEVEL TRAY KIT - 15 x 8 END SQUARE DRAIN (EMKS-EN-1508)

Level Access Kit End Drain
SIZE (mm): 1500 x 800 x 30
Includes installation & drainage kit

£659.00



LEVEL TRAY KIT - 16 x 9 END SQUARE DRAIN (EMKS-EN-1609)

Level Access Kit End Drain
SIZE (mm): 1600 x 900 x 30
Includes installation & drainage kit

£679.00



Centre Drain Kits

LEVEL TRAY KIT - 9 x 9 CENTRE SQUARE DRAIN (EMKS-CE-0909)

Level Access Kit Centre Drain
SIZE (mm): 900 x 900 x 30
Includes installation & drainage kit

£549.00

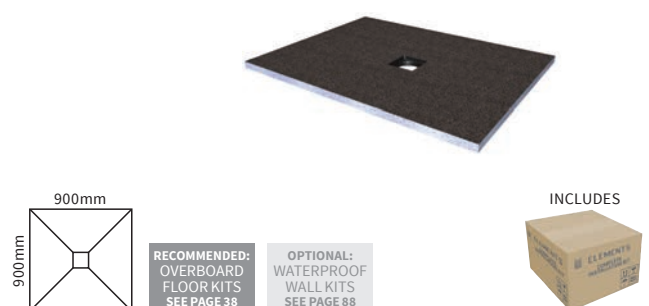

USAGE: The level kits are suitable for both timber and screeded floors. Note: we recommend the use of 10mm Abacus Elements board on the rest of the floor outside the shower tray area. See page 38.

LEVEL TRAY KIT - 10 x 10 CENTRE SQUARE DRAIN

(EMKS-CE-1010)

Level Access Kit Centre Drain

SIZE (mm): 1000 x 1000 x 30

Includes installation & drainage kit

£569.00



LEVEL TRAY KIT - 12 x 12 CENTRE SQUARE DRAIN

(EMKS-CE-1212)

Level Access Kit Centre Drain

SIZE (mm): 1200 x 1200 x 30

Includes installation & drainage kit

£669.00



LEVEL TRAY KIT - 12 x 9 CENTRE SQUARE DRAIN

(EMKS-CE-1209)

Level Access Kit Centre Drain

SIZE (mm): 1200 x 900 x 30

Includes installation & drainage kit

£649.00



LEVEL TRAY KIT - 14 x 9 CENTRE SQUARE DRAIN

(EMKS-CE-1409)

Level Access Kit Centre Drain

SIZE (mm): 1400 x 900 x 30

Includes installation & drainage kit

£659.00



LEVEL TRAY KIT - 16 x 9 CENTRE SQUARE DRAIN

(EMKS-CE-1609)

Level Access Kit Centre Drain

SIZE (mm): 1600 x 900 x 30

Includes installation & drainage kit

£679.00



LEVEL TRAY KIT - 18 x 9 CENTRE SQUARE DRAIN

(EMKS-CE-1809)

Level Access Kit Centre Drain

SIZE (mm): 1800 x 900 x 30

Includes installation & drainage kit

£749.00



Level Access 30mm Shower Tray Kits WITH LINEAR 300 DRAIN



Complete Level Access Shower Tray Kits

All our shower tray kits come complete with a full installation kit

INSTALLATION & DRAINAGE KIT WITH STAINLESS STEEL DRAIN COVER

Installation & Drainage Kit includes:

Pro-SEAL Premix, wood floor primer, horizontal & vertical shower waste, Fix-KST, Fix-MD, waterproof tape, waterproof internal corners, tile guide, paint brush, protective gloves, notched trowel and stainless steel 300mm drain cover.



Usage: The level kits are suitable for both timber and screeded floors.

Note: we recommend the use of 10mm Abacus Elements board on the rest of the floor outside the shower tray area. See page 38.

End Drain Kits

LEVEL TRAY KIT - 9 x 9 END LINEAR 300 DRAIN

(EMK3-EN-0909)

Level Access Kit End Linear 300 Drain

SIZE (mm): 900 x 900 x 30

Includes installation & drainage kit

£579.00



LEVEL TRAY KIT - 10 x 10 END LINEAR 300 DRAIN

(EMK3-EN-1010)

Level Access Kit End Linear 300 Drain

SIZE (mm): 1000 x 1000 x 30

Includes installation & drainage kit

£599.00



LEVEL TRAY KIT - 12 x 12 END LINEAR 300 DRAIN

(EMK3-EN-1212)

Level Access Kit End Linear 300 Drain

SIZE (mm): 1200 x 1200 x 30

Includes installation & drainage kit

£699.00



LEVEL TRAY KIT - 12 x 9 END LINEAR 300 DRAIN

(EMK3-EN-1209)

Level Access Kit End Linear 300 Drain

SIZE (mm): 1200 x 900 x 30

Includes installation & drainage kit

£679.00



LEVEL TRAY KIT - 14 x 9 END LINEAR 300 DRAIN

(EMK3-EN-1409)

Level Access Kit End Linear 300 Drain

SIZE (mm): 1400 x 900 x 30

Includes installation & drainage kit

£689.00



LEVEL TRAY KIT - 16 x 9 END LINEAR 300 DRAIN

(EMK3-EN-1609)

Level Access Kit End Linear 300 Drain

SIZE (mm): 1600 x 900 x 30

Includes installation & drainage kit

£699.00



Centre Drain Kits

LEVEL TRAY KIT - 9 x 9 CENTRE LINEAR 300 DRAIN

(EMK3-CE-0909)

Level Access Kit Centre Linear 300 Drain

SIZE (mm): 900 x 900 x 30

Includes installation & drainage kit

£579.00



LEVEL TRAY KIT - 12 x 12 CENTRE LINEAR 300 DRAIN

(EMK3-CE-1212)

Level Access Kit Centre Linear 300 Drain

SIZE (mm): 1200 x 1200 x 30

Includes installation & drainage kit

£699.00



LEVEL TRAY KIT - 12 x 9 CENTRE LINEAR 300 DRAIN

(EMK3-CE-1209)

Level Access Kit Centre Linear 300 Drain

SIZE (mm): 1200 x 900 x 30

Includes installation & drainage kit

£679.00



LEVEL TRAY KIT - 14 x 9 CENTRE LINEAR 300 DRAIN

(EMK3-CE-1409)

Level Access Kit Centre Linear 300 Drain

SIZE (mm): 1400 x 900 x 30

Includes installation & drainage kit

£689.00



LEVEL TRAY KIT - 16 x 9 CENTRE LINEAR 300 DRAIN

(EMK3-CE-1609)

Level Access Kit Centre Linear 300 Drain

SIZE (mm): 1600 x 900 x 30

Includes installation & drainage kit

£699.00



LEVEL TRAY KIT - 18 x 9 CENTRE LINEAR 300 DRAIN

(EMK3-CE-1809)

Level Access Kit Centre Linear 300 Drain

SIZE (mm): 1800 x 900 x 30

Includes installation & drainage kit

£779.00





Level Access 30mm Shower Tray Kits WITH LINEAR 600 DRAIN

Complete Level Access Shower Tray Kits

All our shower tray kits come complete with a full installation kit

INSTALLATION & DRAINAGE KIT WITH STAINLESS STEEL DRAIN COVER

Installation & Drainage Kit includes:

Pro-SEAL Premix, wood floor primer, horizontal & vertical shower waste, Fix-KST, Fix-MD, waterproof tape, waterproof internal corners, tile guide, paint brush, protective gloves, notched trowel and stainless steel 600mm drain cover.



Offset Centre Drain Kits

LEVEL TRAY KIT - 16 x 9 OFFSET CENTRE LINEAR 600 DRAIN

(EMK6-OF-1609)

Level Access Kit Offset Centre Linear 600 Drain

SIZE (mm): 1600 x 900 x 30

Includes installation & drainage kit

£739.00

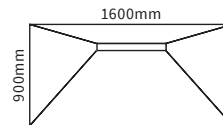

RECOMMENDED:
OVERBOARD
FLOOR KITS
SEE PAGE 38

OPTIONAL:
WATERPROOF
WALL KITS
SEE PAGE 88



INCLUDES



LEVEL TRAY KIT - 18 X 9 OFFSET CENTRE LINEAR 600 DRAIN

(EMK6-OF-1809)

Level Access Kit Offset Centre Linear 600 Drain

SIZE (mm): 1800 x 900 x 30

Includes installation & drainage kit

£799.00

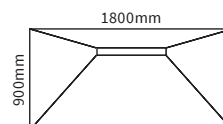

RECOMMENDED:
OVERBOARD
FLOOR KITS
SEE PAGE 38

OPTIONAL:
WATERPROOF
WALL KITS
SEE PAGE 88

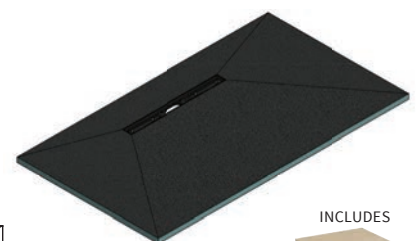

INCLUDES



End Drain Kits

LEVEL TRAY KIT - 9 x 9 END LINEAR 600 DRAIN

(EMK6-EN-0909)

Level Access Kit End Linear 600 Drain

SIZE (mm): 900 x 900 x 30

Includes installation & drainage kit

£599.00



LEVEL TRAY KIT - 12 x 12 END LINEAR 600 DRAIN

(EMK6-EN-1212)

Level Access Kit End Linear 600 Drain

SIZE (mm): 1200 x 1200 x 30

Includes installation & drainage kit

£729.00



LEVEL TRAY KIT - 12 x 9 END LINEAR 600 DRAIN

(EMK6-EN-1209)

Level Access Kit End Linear 600 Drain

SIZE (mm): 1200 x 900 x 30

Includes installation & drainage kit

£699.00



LEVEL TRAY KIT - 14 x 9 END LINEAR 600 DRAIN

(EMK6-EN-1409)

Level Access Kit End Linear 600 Drain

SIZE (mm): 1400 x 900 x 30

Includes installation & drainage kit

£719.00



LEVEL TRAY KIT - 16 x 9 END LINEAR 600 DRAIN

(EMK6-EN-1609)

Level Access Kit End Linear 600 Drain

SIZE (mm): 1600 x 900 x 30

Includes installation & drainage kit

£739.00



Usage: The level kits are suitable for both timber and screeded floors. Note: we recommend the use of 10mm Abacus Elements board on the rest of the floor outside the shower tray area. See page 38.

All prices inclusive of VAT

Overboard Floor Kits for all tiling

PERFECT FOR WATERPROOFING ANY
FLOOR PRIOR TO TILING.

IDEAL FOR:

BATHROOMS

WETROOMS

KITCHENS

CONSERVATORIES





IDEAL FOR TILED KITCHENS



IDEAL FOR TILED CONSERVATORIES



Overboard Floor Kits

WITH ELEMENTS 10mm WATERPROOF INSULATION BOARD

CHOICE OF KIT SIZES AVAILABLE TO SUIT YOUR ROOM, IDEAL FOR WATERPROOFING BATHROOMS, WETROOMS, KITCHENS, CONSERVATORIES OR ANY AREA YOU WISH TO TILE AND KEEP WATERPROOF AND INSULATED.

TYPICAL INSTALLATION

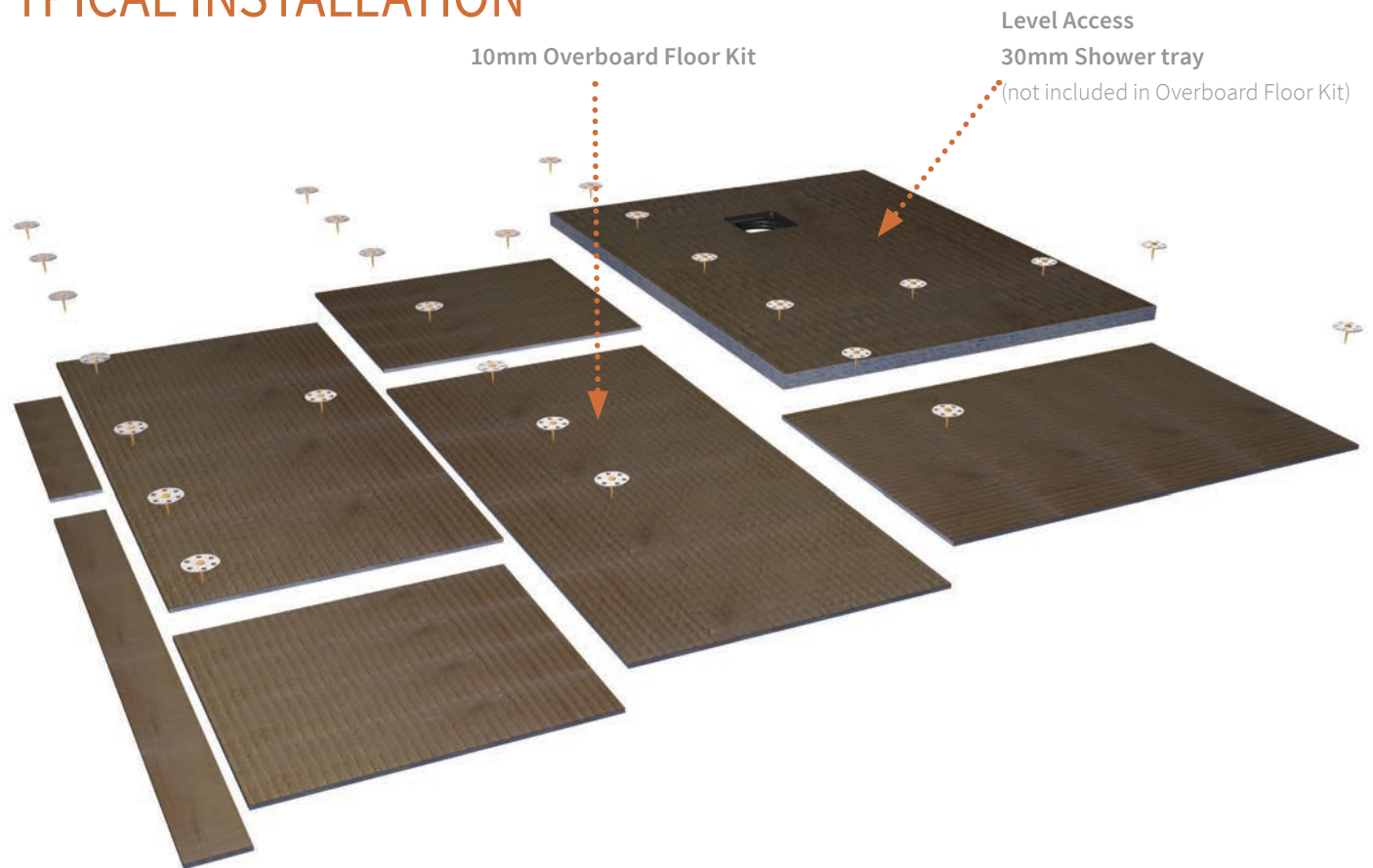

Typical Layout for Level Access Shower Room

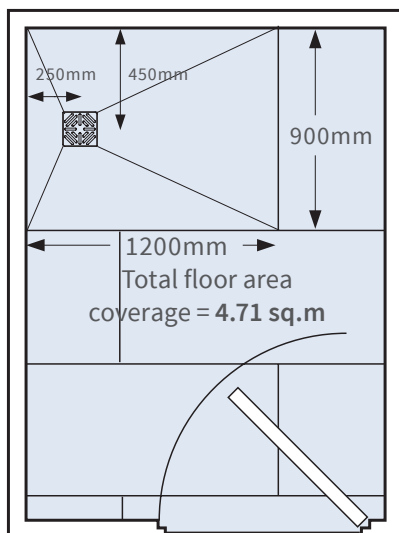

Components required to overboard a floor:

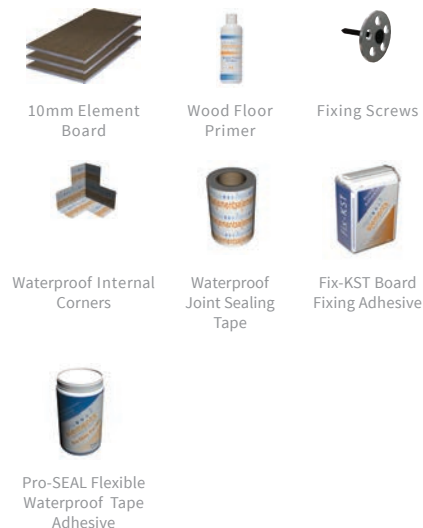

Perfect for use with electric under-tile heating

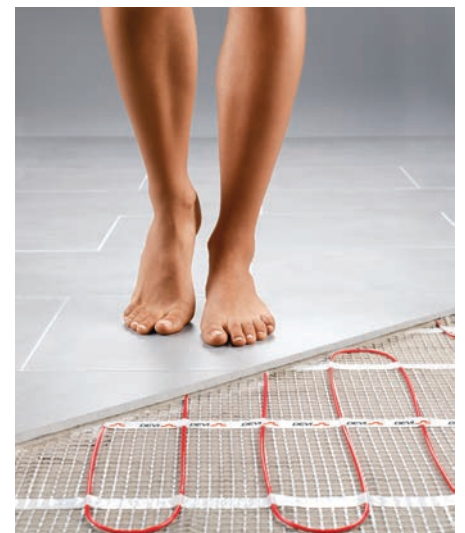

OVERBOARD FLOOR KIT 1 - COVERAGE = 2.16 SQ.M

(EMKB-10-1216)

Kit includes:

- Three 1200 x 600 x 10mm waterproof boards
- Installation kit, including fixing adhesive, fixings, waterproof tape, waterproofing adhesive and accessories

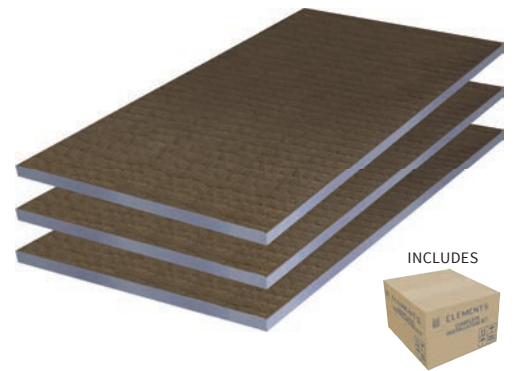
£189.00**OVERBOARD FLOOR KIT 2 - COVERAGE = 3.60 SQ.M**

(EMKB-10-2360)

Kit includes:

- Five 1200 x 600 x 10mm waterproof boards
- Installation kit, including fixing adhesive, fixings, waterproof tape, waterproofing adhesive and accessories

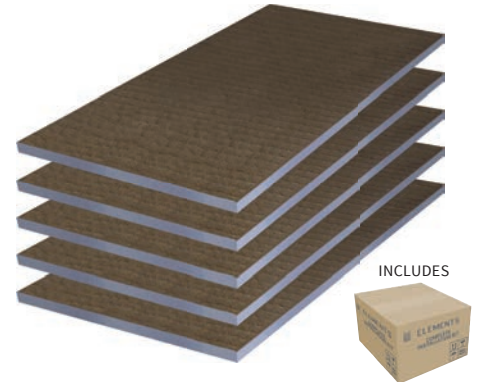
£249.00**OVERBOARD FLOOR KIT 3 - COVERAGE = 7.20 SQ.M**

(EMKB-10-3720)

Kit includes:

- Ten 1200 x 600 x 10mm waterproof boards
- Two Installation Kits, including fixing adhesive, fixings, waterproof tape, waterproofing adhesive and accessories

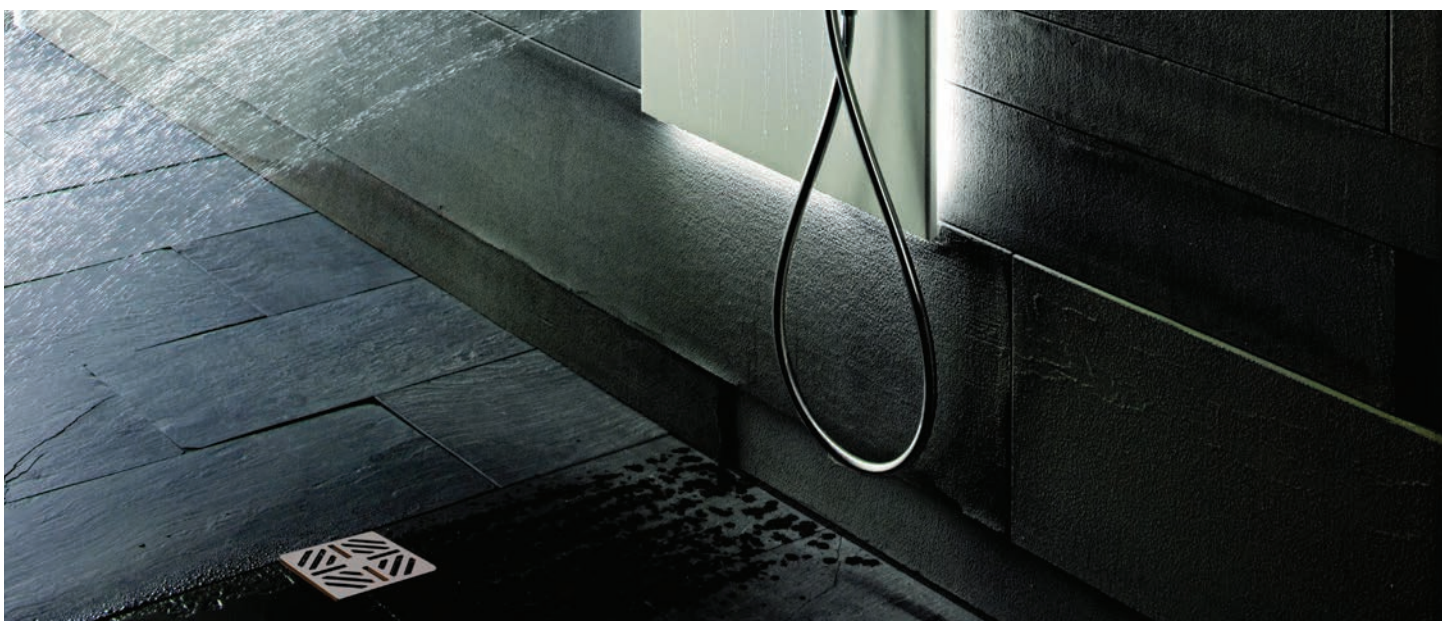
£498.00



Infinity Single Fall Level Access Wetroom System

INFINITY SINGLE FALL WETROOM TRAYS

Infinity gives the ultimate wetroom look for those who want to tile with large format tiles.

The Infinity range offers four standard shower tray sizes and Abacus Elements can also manufacture bespoke sizes to your specific needs.

The drains are flush with the wall and offer a stylish, minimalist look. There are two drain lengths, 700mm and 1000mm, and both come with a high capacity drain trap of up to 42 litres per minute.

Infinity trays are all supplied complete with waterproofing tapes attached and a comprehensive installation kit for total piece of mind and installation ease, all backed with a 15 year guarantee*.

All trays are supplied with Lustrolite tapered tile trim for use at the exposed edges of the tray.

15 year guarantee*

*Guarantee against manufacturing defects, see page 156 for details.



HOW TO PURCHASE - 2 EASY STEPS

1. Choose your shower tray size

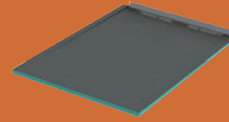

2. Choose your installation position

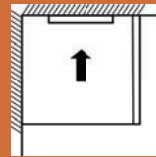

left hand

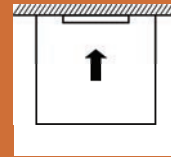

mid wall

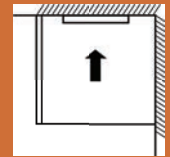

right hand

It is recommended to overboard your floor with 10mm Abacus Elements boards.

See page 38 for our kit options.

Complete your wetroom



FOR WETROOM SCREENS SEE PAGES 128-155



Infinity Single Fall Tray Kits

WITH TILEABLE SLOT DRAIN

INFINITY TRAY KIT - 12 x 9 LEFT HAND/RIGHT HAND

EMKE-L7-1209 (left hand)

EMKE-R7-1209 (right hand)

SIZE (mm): 1200 x 950 x 30

Includes installation & drainage kit

Includes 700mm drain

£779.00

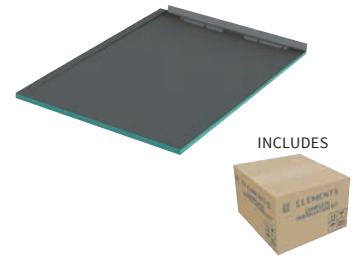
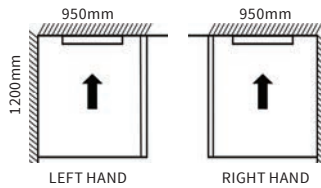

INFINITY TRAY KIT - 14 x 9 LEFT HAND/RIGHT HAND

EMKE-L7-1409 (left hand)

EMKE-R7-1409 (right hand)

SIZE (mm): 1400 x 950 x 30

Includes installation & drainage kit

Includes 700mm drain

£799.00

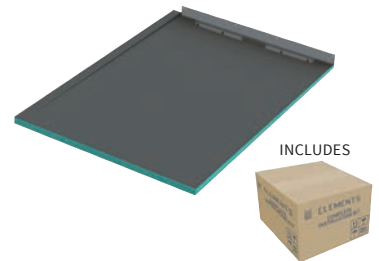
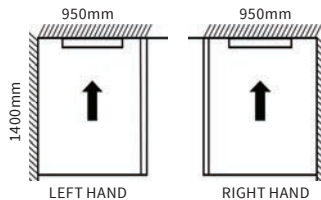

INFINITY TRAY KIT - 12 x 12 LEFT HAND/RIGHT HAND

EMKE-L1-1212 (left hand)

EMKE-R1-1212 (right hand)

SIZE (mm): 1250 x 1200 x 30

Includes installation & drainage kit

Includes 1000mm drain

£899.00

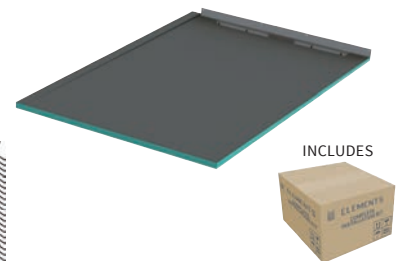
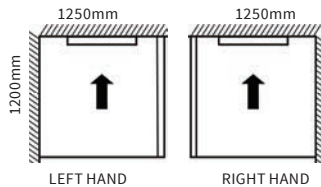

INFINITY TRAY KIT - 18 x 9 WALL TO WALL

EMKE-F1-1809

SIZE (mm): 1800 x 900 x 30

Includes installation & drainage kit

Includes 1000mm drain

£899.00

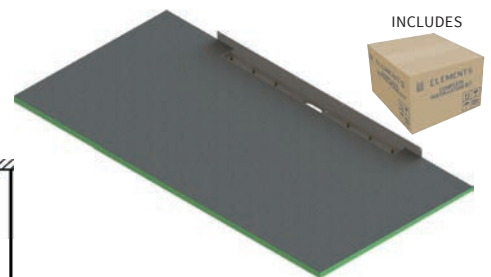
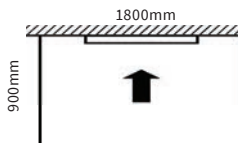

INFINITY TRAY EXTENSION PIECES

EMIT-90-0309

SIZE (mm): 900 x 300 x 30

Includes 2 pieces

£199.00

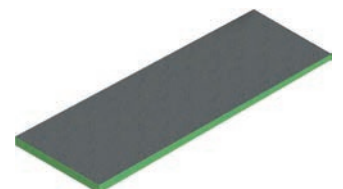
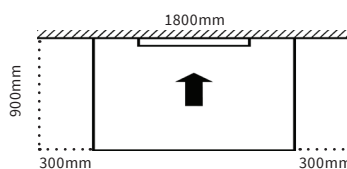

NOTE: only available for 18 x 9 wall-to-wall installation
Kit expands up to 300mm at either or both sides.

All prices inclusive of VAT

Standard 40mm & Level Access 30mm Individual Shower Trays





Standard 40mm Height Shower Trays WITH SQUARE DRAIN



40mm STANDARD SHOWER TRAYS SQUARE DRAIN

Total flexibility in shower tray design - with three installation options as shown below.

All are available with substrate elements should you not be able to position your drain within the floor. Please remember that all standard shower trays are 40mm in height and require a separate drain and installation kit.

Custom Made Options

If your desired shape or size of shower tray is not included in the standard shower tray range, Abacus Elements has the ability to make custom shower trays to your design. Virtually any shapes are possible - simply send your requirements to your Abacus Elements dealer.

Installation Options

1. Above floor installation

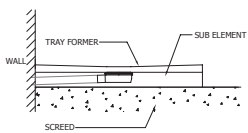

Trap raised above floor
120mm height

2. Low level installation

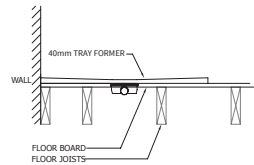

Trap recessed in the floor
40mm height

3. Within screed installation

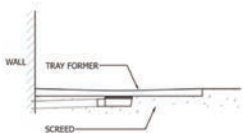

Trap and tray recessed in the floor
Level access

HOW TO PURCHASE - 6 EASY STEPS

1. Choose your shower tray size

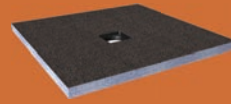

2. Choose your drain position

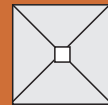

Centre

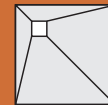

Corner

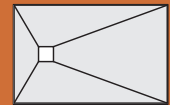

End

3. Order your trap



4. Add raised sub-element if above-floor installation

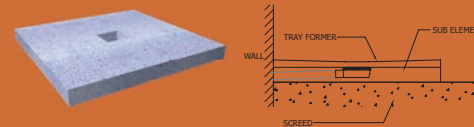

5. Add upgrade drain cover if required



6. Add your installation kit



Complete your wetroom



FOR WETROOM SCREENS SEE PAGES 128-155

Don't forget to consider overboarding your floor.
See page 38 for our kit options.

Standard Shower Trays - 40mm Height

SQUARE DRAIN

SQUARE SHOWER TRAYS WITH CENTRE DRAIN - 40mm

All shower trays require an installation kit and waste/trap

DESCRIPTION	SIZE (mm)	PRODUCT CODE	PRICE
STANDARD SHOWER TRAY 9 X 9 CENTRE	900 x 900 x 25/40	EMST-05-0510	£318.00
STANDARD SHOWER TRAY 10 X 10 CENTRE	1000 x 1000 x 25/40	EMST-05-0515	£330.00
STANDARD SHOWER TRAY 12 X 12 CENTRE	1200 x 1200 x 25/40	EMST-05-0520	£358.00
STANDARD SHOWER TRAY 15 X 15 CENTRE	1500 x 1500 x 25/40	EMST-05-0525	£478.00

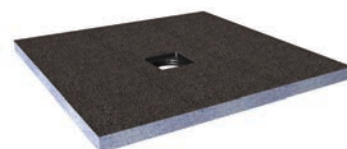
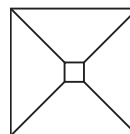

SQUARE SHOWER TRAYS WITH CORNER DRAIN - 40mm

All shower trays require an installation kit and waste/trap

DESCRIPTION	SIZE (mm)	PRODUCT CODE	PRICE
STANDARD SHOWER TRAY 9 X 9 CORNER	900 x 900 x 25/40	EMST-05-1505	£318.00
STANDARD SHOWER TRAY 10 X 10 CORNER	1000 x 1000 x 25/40	EMST-05-1510	£330.00
STANDARD SHOWER TRAY 12 X 12 CORNER	1200 x 1200 x 25/40	EMST-05-1515	£358.00
STANDARD SHOWER TRAY 15 X 15 CORNER	1500 x 1500 x 25/40	EMST-05-1520	£478.00

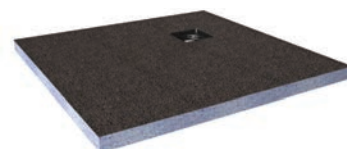
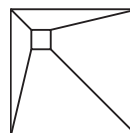

RECTANGULAR SHOWER TRAYS WITH CENTRE DRAIN - 40mm

All shower trays require an installation kit and waste/trap

DESCRIPTION	SIZE (mm)	PRODUCT CODE	PRICE
STANDARD SHOWER TRAY 10 X 9 CENTRE	1000 x 900 x 25/40	EMST-10-0505	£330.00
STANDARD SHOWER TRAY 12 X 9 CENTRE	1200 x 900 x 25/40	EMST-10-0510	£358.00
STANDARD SHOWER TRAY 14 X 9 CENTRE	1400 x 900 x 25/40	EMST-10-0515	£406.00
STANDARD SHOWER TRAY 16 X 9 CENTRE	1600 x 900 x 25/40	EMST-10-0520	£442.00
STANDARD SHOWER TRAY 18 X 9 CENTRE	1800 x 900 x 25/40	EMST-10-0525	£467.00

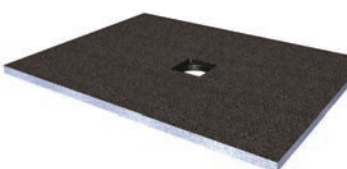
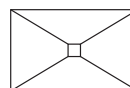

RECTANGULAR SHOWER TRAYS WITH END DRAIN - 40mm

All shower trays require an installation kit and waste/trap

DESCRIPTION	SIZE (mm)	PRODUCT CODE	PRICE
STANDARD SHOWER TRAY 12 X 9 END	1200 x 900 x 25/40	EMST-10-1005	£358.00
STANDARD SHOWER TRAY 12 X 10 END	1200 x 1000 x 25/40	EMST-10-1010	£406.00
STANDARD SHOWER TRAY 14 X 9 END	1400 x 900 x 25/40	EMST-10-1015	£406.00
STANDARD SHOWER TRAY 16 X 9 END	1600 x 900 x 25/40	EMST-10-1020	£442.00

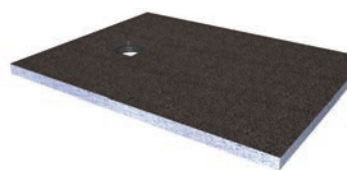
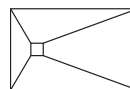

QUADRANT SHOWER TRAYS WITH CORNER DRAIN - 30mm HEIGHT ONLY

All shower trays require an installation kit and waste/trap

DESCRIPTION	SIZE (mm)	PRODUCT CODE	PRICE
STD. QUADRANT SHOWER TRAY - 500mm RADIUS 9 x 9 CORNER	900 x 900 x 20/30	EMST-20-1505	£354.00
STD. QUADRANT SHOWER TRAY - 550mm RADIUS 9 x 9 CORNER	900 x 900 x 20/30	EMST-20-1510	£354.00

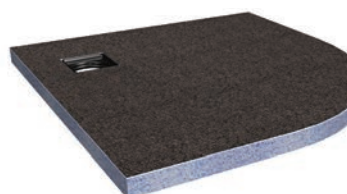
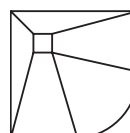

PENTAGON SHOWER TRAYS WITH CORNER DRAIN - 30mm HEIGHT ONLY

All shower trays require an installation kit and waste/trap

DESCRIPTION	SIZE (mm)	PRODUCT CODE	PRICE
STD. PENTAGON SHOWER TRAY 9 x 9 CORNER	900 x 900 x 20/30	EMST-15-1505	£342.00
STD. PENTAGON SHOWER TRAY 10 x 10 CORNER	1000 x 1000 x 20/30	EMST-15-1510	£390.00

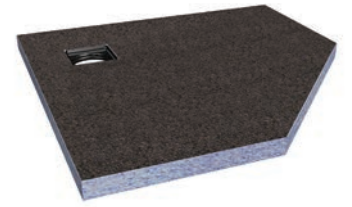
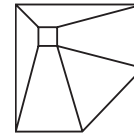

Sub-Elements

TO RAISE THE TRAP ABOVE FLOOR LEVEL IF REQUIRED

SQUARE UNIVERSAL SUB-ELEMENTS

DESCRIPTION	SIZE (mm)	PRODUCT CODE	PRICE
SQUARE SUBSTRATE ELEMENT 9 x 9 CORNER/CENTRE	900 x 900 x 80	EMSE-05-9009	£58.00
SQUARE SUBSTRATE ELEMENT 10 x 10 CORNER/CENTRE	1000 x 1000 x 80	EMSE-05-9010	£68.00
SQUARE SUBSTRATE ELEMENT 12 x 12 CORNER/CENTRE	1200 x 1200 x 80	EMSE-05-9012	£82.00
SQUARE SUBSTRATE ELEMENT 15 x 15 CORNER/CENTRE	1500 x 1500 x 80	EMSE-05-9015	£149.00

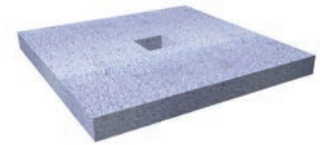

RECTANGULAR UNIVERSAL SUB-ELEMENTS

DESCRIPTION	SIZE (mm)	PRODUCT CODE	PRICE
RECTANGULAR SUBSTRATE ELEMENT 12, 14 & 16 X 9 END/CENTRE SUPPLIED AS 16 X 9 TO BE CUT TO SMALLER TRAY SIZE ON SITE	1200-1600 x 900 x 80	EMSE-50-9005	£89.00
RECTANGULAR SUBSTRATE ELEMENT 18 x 9 END/CENTRE	1800 x 900 x 80	EMSE-50-9018	£115.00

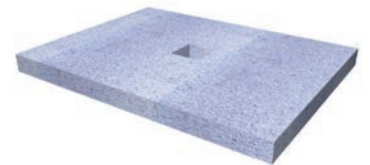

QUADRANT SUB-ELEMENTS

DESCRIPTION	SIZE (mm)	PRODUCT CODE	PRICE
QUADRANT SUBSTRATE ELEMENT 9 x 9 CORNER 500mm RADIUS	900 x 900 x 90	EMSE-20-1505	£72.00
QUADRANT SUBSTRATE ELEMENT 9 x 9 CORNER 550mm RADIUS	900 x 900 x 90	EMSE-20-1510	£72.00

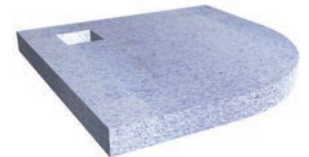





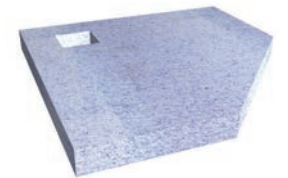



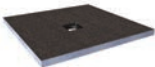

PENTAGON SUB-ELEMENTS

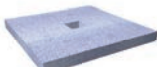
DESCRIPTION	SIZE (mm)	PRODUCT CODE	PRICE
PENTAGON SUBSTRATE ELEMENT 9 x 9 CORNER/CENTRE	900 x 900 x 90	EMSE-15-1505	£72.00
PENTAGON SUBSTRATE ELEMENT 10 x 10 CORNER/CENTRE	1000 x 1000 x 90	EMSE-15-1510	£83.00



BESPOKE: Bespoke sub-elements can be made to order, please contact our Sales Department.

When ordering your square drain shower tray you require:

1.	2.	3.	4.	5.
tray	waste	sub-element	designer grid	installation kit
				
				
required	required	optional	optional upgrade	required

Standard 40mm Height Shower Trays WITH LINEAR 300 DRAIN



40mm STANDARD SHOWER TRAYS LINEAR 300 DRAIN

Total flexibility in shower tray design - with three installation options (as shown below).

All are available with substrate elements should you not be able to position your drain within the floor. Please remember that all standard shower trays are 40mm in height and require a separate drain and installation kit.

Custom Made Options

If your desired shape or size of shower tray is not included in the standard shower tray range, Abacus Elements has the ability to make custom shower trays to your design. Virtually any shapes are possible - simply send your requirements to your Abacus Elements dealer.

Installation Options

1. Above floor installation

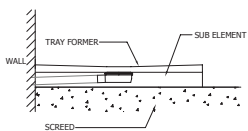

Trap raised above floor
130mm height

2. Low level installation

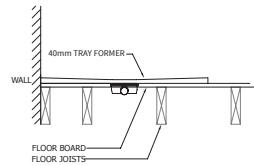

Trap recessed in the floor
40mm height

3. Within screed installation

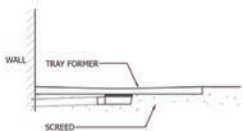

Trap and tray recessed in the floor
Level access

HOW TO PURCHASE - 6 EASY STEPS

1. Choose your shower tray size

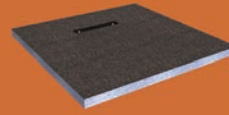

2. Choose your drain position

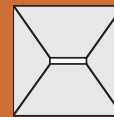

Centre

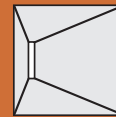

End

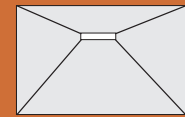

Offset

3. Order your trap



4. Add raised sub-element if above-floor installation

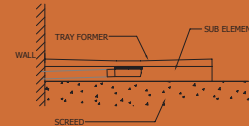
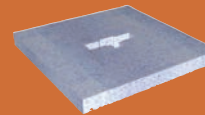

5. Add drain cover (required)

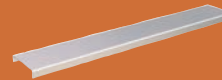

6. Add your installation kit



Complete your wetroom



FOR WETROOM SCREENS SEE PAGES 128-155

Don't forget to consider overboarding your floor.
See page 38 for our kit options.

Standard Shower Trays - 40mm Height

LINEAR 300 DRAIN

SQUARE LINEAR 300 SHOWER TRAYS WITH CENTRE DRAIN - 40mm

All shower trays require an installation kit and waste/trap

DESCRIPTION	SIZE (mm)	PRODUCT CODE	PRICE
STANDARD SHOWER TRAY 9 X 9 CENTRE	900 x 900 x 25/40	EMLT-05-0509	£318.00
STANDARD SHOWER TRAY 12 X 12 CENTRE	1200 x 1200 x 25/40	EMLT-05-0512	£359.00
STANDARD SHOWER TRAY 15 X 15 CENTRE	1500 x 1500 x 25/40	EMLT-05-0515	£479.00

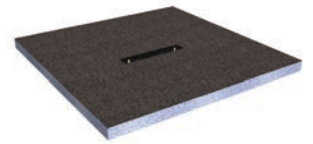
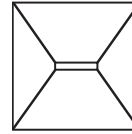

SQUARE LINEAR 300 SHOWER TRAYS WITH END DRAIN - 40mm

All shower trays require an installation kit and waste/trap

DESCRIPTION	SIZE (mm)	PRODUCT CODE	PRICE
STANDARD SHOWER TRAY 9 X 9 END	900 x 900 x 25/40	EMLT-05-1009	£318.00
STANDARD SHOWER TRAY 12 X 12 END	1200 x 1200 x 25/40	EMLT-05-1012	£359.00
STANDARD SHOWER TRAY 15 X 15 END	1500 x 1500 x 25/40	EMLT-05-1015	£479.00

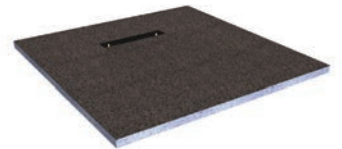
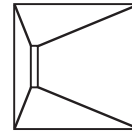

RECTANGULAR LINEAR 300 SHOWER TRAYS WITH CENTRE DRAIN - 40mm

All shower trays require an installation kit and waste/trap

DESCRIPTION	SIZE (mm)	PRODUCT CODE	PRICE
STANDARD SHOWER TRAY 12 X 9 CENTRE	1200 x 900 x 25/40	EMLT-10-0512	£359.00
STANDARD SHOWER TRAY 14 X 9 CENTRE	1400 x 900 x 25/40	EMLT-10-0514	£409.00
STANDARD SHOWER TRAY 16 X 9 CENTRE	1600 x 900 x 25/40	EMLT-10-0516	£443.00
STANDARD SHOWER TRAY 18 X 9 CENTRE	1800 x 900 x 25/40	EMLT-10-0518	£467.00

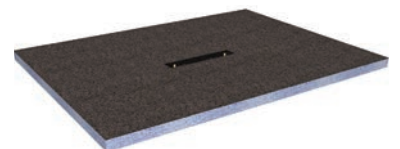
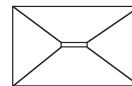

RECTANGULAR LINEAR 300 SHOWER TRAYS WITH END DRAIN - 40mm

All shower trays require an installation kit and waste/trap

DESCRIPTION	SIZE (mm)	PRODUCT CODE	PRICE
STANDARD SHOWER TRAY 12 X 9 END	1200 x 900 x 25/40	EMLT-10-1012	£359.00
STANDARD SHOWER TRAY 14 X 9 END	1400 x 900 x 25/40	EMLT-10-1014	£409.00
STANDARD SHOWER TRAY 16 X 9 END	1600 x 900 x 25/40	EMLT-10-1016	£443.00
STANDARD SHOWER TRAY 18 X 9 END	1800 x 900 x 25/40	EMLT-10-1018	£467.00

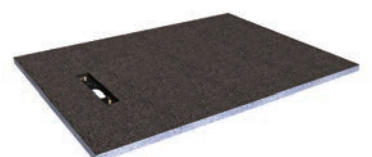
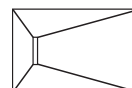

RECTANGULAR LINEAR 300 SHOWER TRAYS WITH OFFSET DRAIN - 40mm

All shower trays require an installation kit and waste/trap

DESCRIPTION	SIZE (mm)	PRODUCT CODE	PRICE
STANDARD SHOWER TRAY 12 X 9	1200 x 900 x 25/40	EMLT-10-2012	£359.00
STANDARD SHOWER TRAY 14 X 9	1400 x 900 x 25/40	EMLT-10-2014	£409.00
STANDARD SHOWER TRAY 16 X 9	1600 x 900 x 25/40	EMLT-10-2016	£443.00
STANDARD SHOWER TRAY 18 X 9	1800 x 900 x 25/40	EMLT-10-2018	£467.00

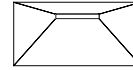

Sub Elements

TO RAISE THE TRAP ABOVE FLOOR LEVEL IF REQUIRED

SQUARE UNIVERSAL SUB-ELEMENTS

DESCRIPTION	SIZE (mm)	PRODUCT CODE	PRICE
SQUARE SUBSTRATE ELEMENT 9 x 9 END/CENTRE	900 x 900 x 90	EMSE-60-9009	£66.00
SQUARE SUBSTRATE ELEMENT 12 x 12 END/CENTRE	1200 x 1200 x 90	EMSE-60-9012	£90.00
SQUARE SUBSTRATE ELEMENT 15 x 15 END/CENTRE	1500 x 1500 x 90	EMSE-60-9015	£168.00

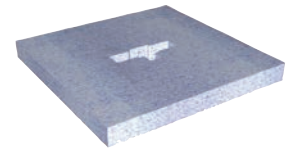

RECTANGULAR UNIVERSAL SUB-ELEMENTS (END & CENTRE DRAIN)

DESCRIPTION	SIZE (mm)	PRODUCT CODE	PRICE
RECTANGULAR SUBSTRATE ELEMENT 12, 14 & 16 X 9 END/CENTRE SUPPLIED AS 16 X 9 TO BE CUT TO SMALLER TRAY SIZE ON SITE	1200-1600 x 900 x 90	EMSE-60-9005	£89.00
RECTANGULAR SUBSTRATE ELEMENT 18 x 9 END/CENTRE	1800 x 900 x 90	EMSE-60-9018	£115.00

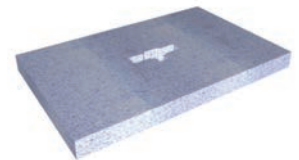





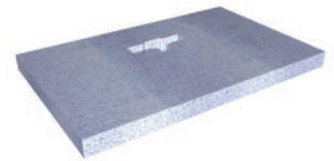



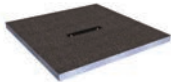

RECTANGULAR SUB-ELEMENTS (OFFSET DRAIN)

DESCRIPTION	SIZE (mm)	PRODUCT CODE	PRICE
RECTANGULAR SUBSTRATE ELEMENT 12 x 9 OFFSET	1200 x 900 x 90	EMSE-10-3012	£90.00
RECTANGULAR SUBSTRATE ELEMENT 14 x 9 OFFSET	1400 x 900 x 90	EMSE-10-3014	£99.00
RECTANGULAR SUBSTRATE ELEMENT 16 x 9 OFFSET	1600 x 900 x 90	EMSE-10-3016	£114.00
RECTANGULAR SUBSTRATE ELEMENT 18 x 9 OFFSET	1800 x 900 x 90	EMSE-10-3018	£126.00



BESPOKE: Bespoke sub-elements can be made to order, please contact our Sales Department.

When ordering your linear drain shower tray you require:

1.	2.	3.	4.	5.
tray	waste	sub-element	waste grid	installation kit
			 or 	
				
required	required	optional	required	required

Note: All Linear Shower Trays require waste trap, installation kit and drain cover, please see page 69

Level Access 30mm Height Shower Trays WITH SQUARE DRAIN



30mm LEVEL ACCESS SHOWER TRAYS SQUARE DRAIN

Total flexibility in shower tray design - with two installation options (as shown below).

Level Access Shower Trays

Specifically designed for the UK market where bathroom floors are overboarded with either plywood or Elements board. These trays are 30mm in height and give a completely flush tiled floor after installation.

Custom Made Options

If your desired shape or size of shower tray is not included in the standard shower tray range don't worry! Abacus Elements has the ability to make custom shower trays to your design. Virtually any shapes are possible - simply send your requirements to your Abacus Elements dealer.

Installation Options

1. Level Access installation

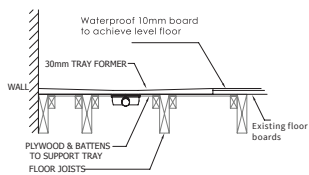

2. Low level installation

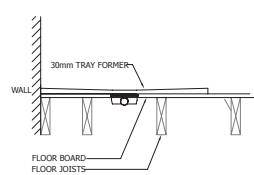

HOW TO PURCHASE - 5 EASY STEPS

1. Choose your shower tray size

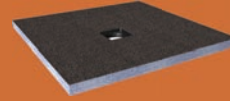

2. Choose your drain position

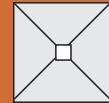

Centre

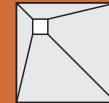

Corner

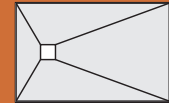

End

3. Order your trap



4. Add upgrade drain cover if required



5. Add your installation kit



Complete your wetroom



FOR WETROOM SCREENS SEE PAGES 128-155

Don't forget to consider overboarding your floor. See page 38 for our kit options.

Level Access Shower Trays - 30mm Height

SQUARE DRAIN

SQUARE SHOWER TRAYS WITH CORNER DRAIN - 30mm

All shower trays require an installation kit and waste/trap

DESCRIPTION	SIZE (mm)	PRODUCT CODE	PRICE
LEVEL SHOWER TRAY 9 X 9 CORNER	900 x 900 x 25/30	EMST-05-8005	£394.00
LEVEL SHOWER TRAY 10 X 10 CORNER	1000 x 1000 x 25/30	EMST-05-8015	£429.00
LEVEL SHOWER TRAY 12 X 12 CORNER	1200 x 1200 x 25/30	EMST-05-8010	£499.00

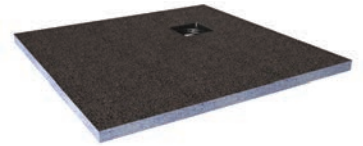
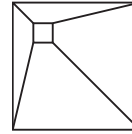

SQUARE SHOWER TRAYS WITH CENTRE DRAIN - 30mm

All shower trays require an installation kit and waste/trap

DESCRIPTION	SIZE (mm)	PRODUCT CODE	PRICE
LEVEL SHOWER TRAY 9 X 9 CENTRE	900 x 900 x 25/30	EMST-05-8505	£394.00
LEVEL SHOWER TRAY 10 X 10 CENTRE	1000 x 1000 x 25/30	EMST-05-8515	£429.00
LEVEL SHOWER TRAY 12 X 12 CENTRE	1200 x 1200 x 25/30	EMST-05-8510	£499.00

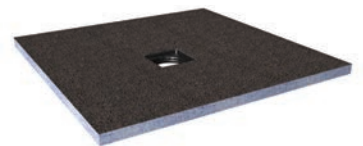
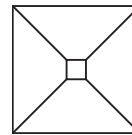

RECTANGULAR SHOWER TRAYS WITH CENTRE DRAIN - 30mm

All shower trays require an installation kit and waste/trap

DESCRIPTION	SIZE (mm)	PRODUCT CODE	PRICE
LEVEL SHOWER TRAY 12 X 9 CENTRE	1200 x 900 x 25/30	EMST-10-8505	£479.00
LEVEL SHOWER TRAY 14 X 9 CENTRE	1400 x 900 x 25/30	EMST-10-8515	£499.00
LEVEL SHOWER TRAY 16 X 9 CENTRE	1600 x 900 x 25/30	EMST-10-8510	£515.00
LEVEL SHOWER TRAY 18 X 9 CENTRE	1800 x 900 x 25/30	EMST-10-8520	£549.00

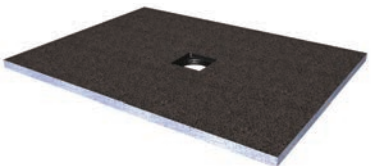
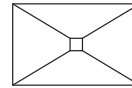

RECTANGULAR SHOWER TRAYS WITH END DRAIN - 30mm

All shower trays require an installation kit and waste/trap

DESCRIPTION	SIZE (mm)	PRODUCT CODE	PRICE
LEVEL SHOWER TRAY 12 X 9 END	1200 x 900 x 25/30	EMST-10-7505	£479.00
LEVEL SHOWER TRAY 14 X 9 END	1400 x 900 x 25/30	EMST-10-7520	£499.00
LEVEL SHOWER TRAY 15 X 8 END	1500 x 800 x 25/30	EMST-10-7515	£510.00
LEVEL SHOWER TRAY 16 X 9 END	1600 x 900 x 25/30	EMST-10-7510	£515.00

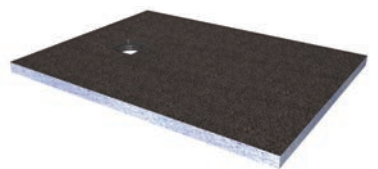
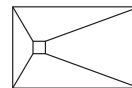

QUADRANT SHOWER TRAYS WITH CORNER DRAIN - 30mm

All shower trays require an installation kit and waste/trap

DESCRIPTION	SIZE (mm)	PRODUCT CODE	PRICE
STD. QUADRANT SHOWER TRAY - 500mm RADIUS 9 x 9 CORNER	900 x 900 x 20/30	EMST-20-1505	£354.00
STD. QUADRANT SHOWER TRAY - 550mm RADIUS 9 x 9 CORNER	900 x 900 x 20/30	EMST-20-1510	£354.00

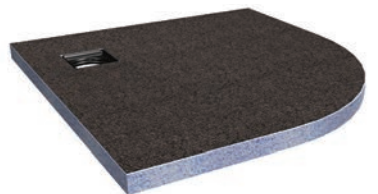
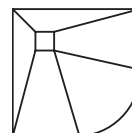

PENTAGON SHOWER TRAYS WITH CORNER DRAIN - 30mm

All shower trays require an installation kit and waste/trap

DESCRIPTION	SIZE (mm)	PRODUCT CODE	PRICE
STD. PENTAGON SHOWER TRAY 9 x 9 CORNER	900 x 900 x 20/30	EMST-15-1505	£342.00
STD. PENTAGON SHOWER TRAY 10 x 10 CORNER	1000 x 1000 x 20/30	EMST-15-1510	£390.00

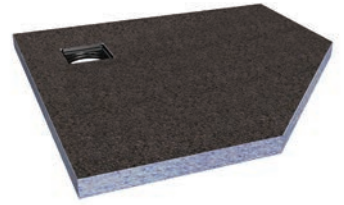
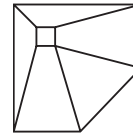

When ordering your square drain shower tray you require:

1.

tray

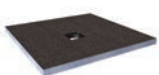

required



2.

waste



required



3.

designer grid



optional
upgrade

All prices inclusive of VAT



4.

installation kit



required

Level Access 30mm Height Shower Trays WITH LINEAR 300 DRAIN

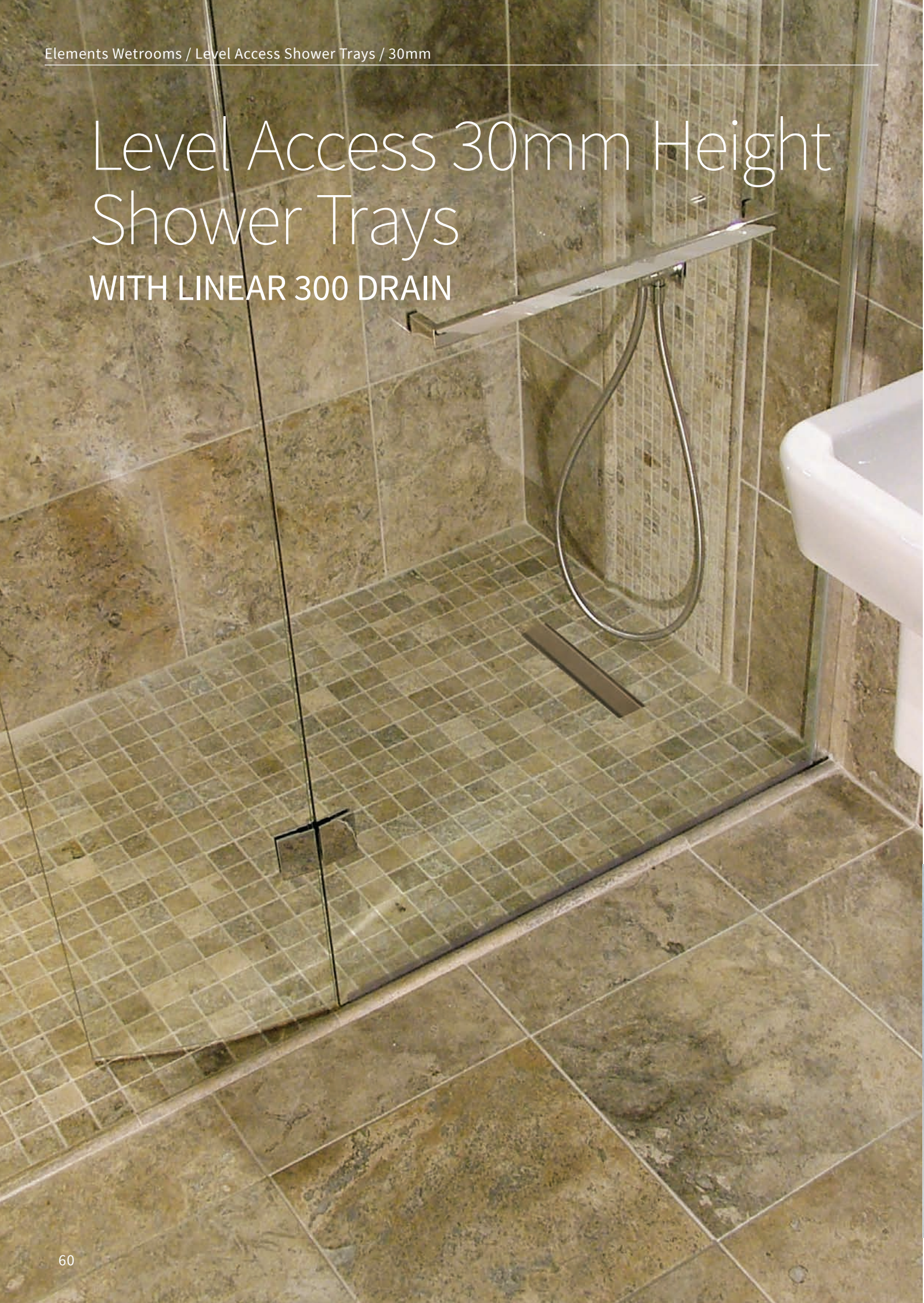

30mm LEVEL ACCESS SHOWER TRAYS LINEAR 300 DRAIN

Total flexibility in shower tray design - with two installation options (as shown below).

Level Access Shower Trays

Specifically designed for the UK market where bathroom floors are overboarded with either plywood or Elements board. These trays are 30mm in height and give a completely flush tiled floor after installation.

Custom Made Options

If your desired shape or size of shower tray is not included in the standard shower tray range don't worry! Abacus Elements has the ability to make custom shower trays to your design. Virtually any shapes are possible - simply send your requirements to your Abacus Elements dealer.

Installation Options

1. Level Access installation

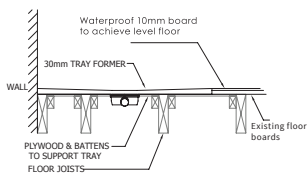

2. Low level installation

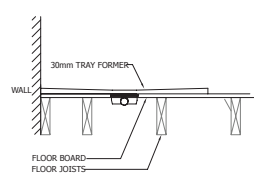

HOW TO PURCHASE - 5 EASY STEPS

1. Choose your shower tray size

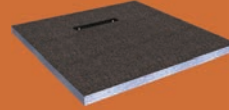

2. Choose your drain position

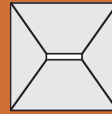

Centre

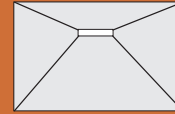

Offset



End

3. Order your trap



4. Add drain cover (required)

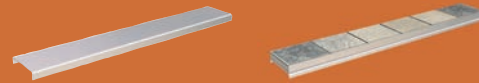

5. Add your installation kit



Complete your wetroom



FOR WETROOM SCREENS SEE PAGES 128-155

Don't forget to consider overboarding your floor. See page 38 for our kit options.

Level Access Shower Trays - 30mm Height

LINEAR 300 DRAIN

SQUARE LINEAR 300 SHOWER TRAYS WITH CENTRE DRAIN - 30mm

All shower trays require an installation kit and waste/trap

DESCRIPTION	SIZE (mm)	PRODUCT CODE	PRICE
LEVEL ACCESS SHOWER TRAY 9 x 9 CENTRE	900 x 900 x 25/30	EMLT-05-8509	£370.00
LEVEL ACCESS SHOWER TRAY 10 x 10 CENTRE	1000 x 1000 x 25/30	EMLT-05-8510	£429.00
LEVEL ACCESS SHOWER TRAY 12 x 12 CENTRE	1200 x 1200 x 25/30	EMLT-05-8512	£499.00

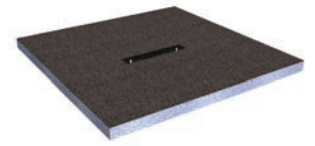
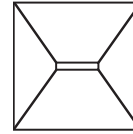

SQUARE LINEAR 300 SHOWER TRAYS WITH END DRAIN - 30mm

All shower trays require an installation kit and waste/trap

DESCRIPTION	SIZE (mm)	PRODUCT CODE	PRICE
LEVEL ACCESS SHOWER TRAY 9 x 9 END	900 x 900 x 25/30	EMLT-05-7509	£370.00
LEVEL ACCESS SHOWER TRAY 10 x 10 END	1000 x 1000 x 25/30	EMLT-05-7510	£429.00
LEVEL ACCESS SHOWER TRAY 12 x 12 END	1200 x 1200 x 25/30	EMLT-05-7512	£499.00

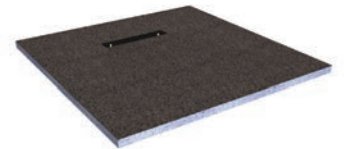
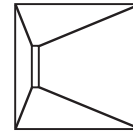

RECTANGULAR LINEAR 300 SHOWER TRAYS WITH CENTRE DRAIN - 30mm

All shower trays require an installation kit and waste/trap

DESCRIPTION	SIZE (mm)	PRODUCT CODE	PRICE
LEVEL ACCESS SHOWER TRAY 12 x 9 CENTRE	1200 x 900 x 25/30	EMLT-10-8512	£479.00
LEVEL ACCESS SHOWER TRAY 14 x 9 CENTRE	1400 x 900 x 25/30	EMLT-10-8514	£499.00
LEVEL ACCESS SHOWER TRAY 16 x 9 CENTRE	1600 x 900 x 25/30	EMLT-10-8516	£515.00
LEVEL ACCESS SHOWER TRAY 18 x 9 CENTRE	1800 x 900 x 25/30	EMLT-10-8518	£549.00

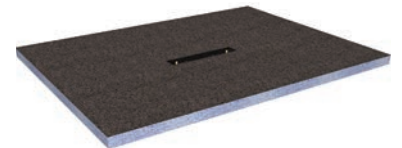
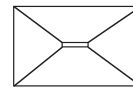

RECTANGULAR LINEAR 300 SHOWER TRAYS WITH END DRAIN - 30mm

All shower trays require an installation kit and waste/trap

DESCRIPTION	SIZE (mm)	PRODUCT CODE	PRICE
LEVEL ACCESS SHOWER TRAY 12 x 9 END	1200 x 900 x 25/30	EMLT-10-7512	£479.00
LEVEL ACCESS SHOWER TRAY 14 x 9 END	1400 x 900 x 25/30	EMLT-10-7514	£499.00
LEVEL ACCESS SHOWER TRAY 16 x 9 END	1600 x 900 x 25/30	EMLT-10-7516	£515.00

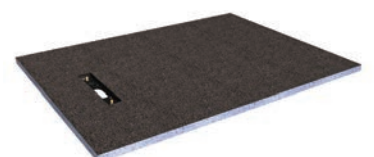
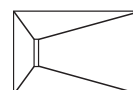

RECTANGULAR LINEAR 300 SHOWER TRAY WITH OFFSET DRAIN - 30mm

All shower trays require an installation kit and waste/trap

DESCRIPTION	SIZE (mm)	PRODUCT CODE	PRICE
LEVEL ACCESS SHOWER TRAY 16 X 9	1600 x 900 x 25/30	EMLT-10-8016	£515.00
LEVEL ACCESS SHOWER TRAY 18 X 9	1800 x 900 x 25/30	EMLT-10-8018	£549.00

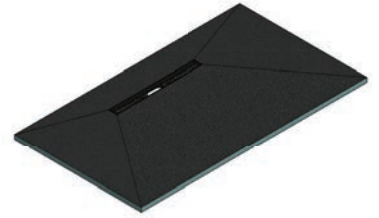
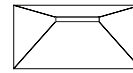

BESPOKE: Bespoke shower trays can be made to order, please contact our Sales Department.

When ordering your linear drain shower tray you require:

- 1.**
tray

required
- 2.**
waste

required
- 3.**
waste grid

required
- 4.**
installation kit

required

Note: All Linear Shower Trays require waste trap, installation kit and drain cover, please see page 69

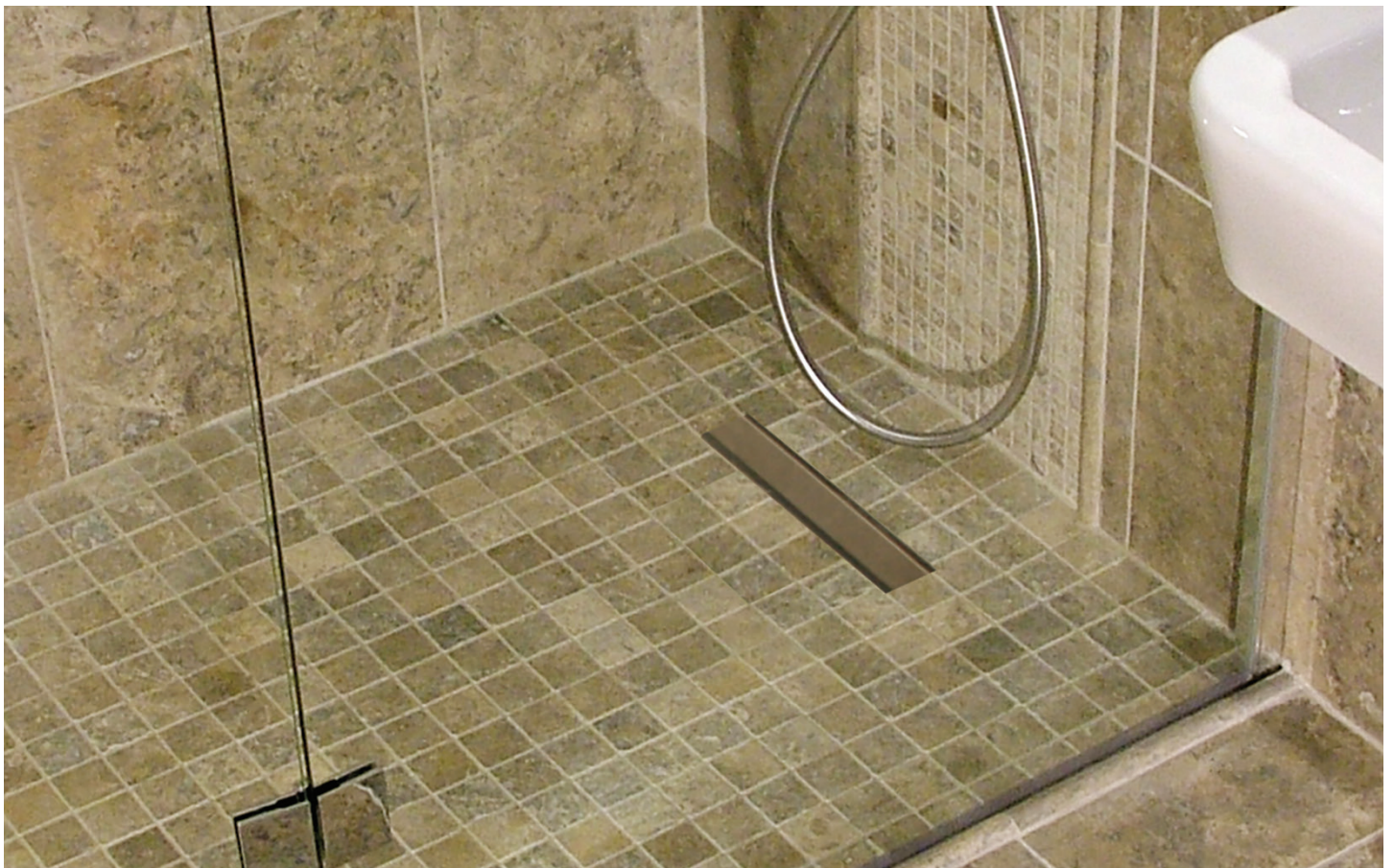

Level Access 30mm Height Shower Trays

WITH LINEAR 600 DRAIN



30mm LEVEL ACCESS SHOWER TRAYS LINEAR 600 DRAIN

Total flexibility in shower tray design - with two installation options (as shown below).

Level Access Shower Trays

Specifically designed for the UK market where bathroom floors are overboarded with either plywood or Elements board. These trays are 30mm in height and give a completely flush tiled floor after installation.

Custom Made Options

If your desired shape or size of shower tray is not included in the standard shower tray range don't worry! Abacus Elements has the ability to make custom shower trays to your design. Virtually any shapes are possible - simply send your requirements to your Abacus Elements dealer.

Installation Options

1. Level Access installation

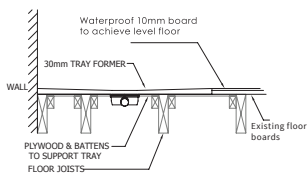

2. Low level installation

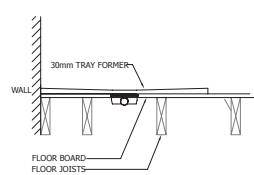

HOW TO PURCHASE - 5 EASY STEPS

1. Choose your shower tray size



2. Choose your drain position

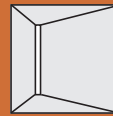

End

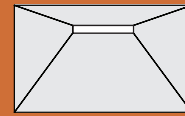

Offset

3. Order your trap



4. Add drain cover



5. Add your installation kit



Complete your wetroom



FOR WETROOM SCREENS SEE PAGES 128-155

Don't forget to consider overboarding your floor. See page 38 for our kit options.

Level Access Shower Trays - 30mm Height

LINEAR 600 DRAIN

SQUARE LINEAR 600 SHOWER TRAYS WITH END DRAIN - 30mm

All shower trays require an installation kit and waste/trap

DESCRIPTION	SIZE (mm)	PRODUCT CODE	PRICE
LEVEL ACCESS SHOWER TRAY 9 x 9 END	900 x 900 x 25/30	EMLT-25-7509	£370.00
LEVEL ACCESS SHOWER TRAY 12 x 12 END	1200 x 1200 x 25/30	EMLT-25-7512	£499.00

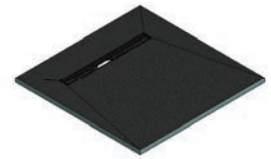
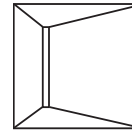

RECTANGULAR LINEAR 600 SHOWER TRAY WITH END DRAIN - 30mm

All shower trays require an installation kit and waste/trap

DESCRIPTION	SIZE (mm)	PRODUCT CODE	PRICE
LEVEL ACCESS SHOWER TRAY 12 x 9 END	1200 x 900 x 25/30	EMLT-30-7512	£467.00
LEVEL ACCESS SHOWER TRAY 14 x 9 END	1400 x 900 x 25/30	EMLT-30-7514	£479.00
LEVEL ACCESS SHOWER TRAY 16 x 9 END	1600 x 900 x 25/30	EMLT-30-7516	£499.00

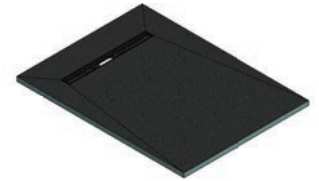
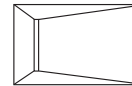

RECTANGULAR LINEAR 600 SHOWER TRAY WITH OFFSET DRAIN - 30mm

All shower trays require an installation kit and waste/trap

DESCRIPTION	SIZE (mm)	PRODUCT CODE	PRICE
LEVEL ACCESS SHOWER TRAY 16 X 9	1600 x 900 x 25/30	EMLT-30-8016	£499.00
LEVEL ACCESS SHOWER TRAY 18 X 9	1800 x 900 x 25/30	EMLT-30-8018	£515.00

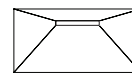

When ordering your linear drain shower tray you require:

- 1.**
tray

required
- 2.**
waste

required
- 3.**
waste grid

or

required
- 4.**
installation kit

required

Note: All Linear Shower Trays require waste trap, installation kit and drain cover, please see page 69



Shower Wastes & Installation Kits - SQUARE DRAIN

SHOWER WASTE - STAINLESS STEEL (REQUIRED WITH ALL SHOWER TRAYS)

(EMTW-15-0005)

- Horizontal Drain - UK 2" Solvent Pipe - inc. S/Steel Grate
- Removable Hair Trap
- High Flow Trap - up to 60L per minute
- Stainless Steel Grate 120 x 120mm

£47.40



DESIGNER SHOWER WASTE - STAINLESS STEEL

(EMTW-25-0005)

- Designer solid Stainless Steel Shower Drain Cover Upgrade Kit
- Allen Key fixings (also suitable for commercial premises)
- Solid Stainless Steel Grate 120 x 120mm

£66.00



TILEABLE SHOWER WASTE

(EMTW-15-0010)

- Horizontal Drain - UK 2" Solvent Pipe - inc. Tileable Grate
- Removable Hair Trap
- High Flow Trap - up to 60L per minute
- IMPORTANT NOTE: This tileable drain is only suitable where the tile thickness + the adhesive thickness is a minimum of 13mm

£47.40

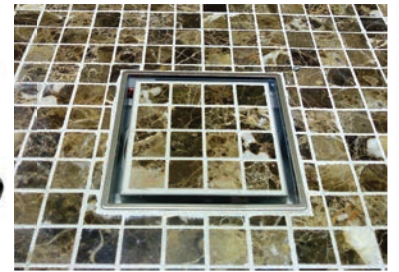

SHOWER TRAY INSTALLATION KIT

(EMAP-02-2505)

- For the installation and waterproofing of all shower trays
- Fix-KST Fixing Adhesive, Pro-SEAL (pre-mixed), Waterproofing Tape, Wood Floor Primer, Waterproofing Internal Corners, Protective Gloves

£99.60



Note: A standard Shower Tray Installation Kit contains 5kg Fix-KST fixing adhesive. This is suitable for approximately 2 square metres of screeded bedding. If you are bedding large shower trays with substrate elements eg. 1600 x 900mm please purchase additional Fix-KST as below:

FIX-KST FIXING ADHESIVE

- For adhering tray, sub-element or boards to any floor
- For adhering wall boards to a brick or block wall

(EMAS-05-0005) 5KG BAG

£17.50

(EMAS-05-0010) 20KG BAG

£59.00



WOOD FLOOR PRIMER

(TLTA-15-2005)

- To be used if you are fixing onto timber floors
- 1L Wood Floor Primer
- Covers approx. 10 sq. m

£22.50



Shower Wastes & Installation Kits - LINEAR DRAIN

LINEAR WASTE TRAP KIT (REQUIRED FOR ALL LINEAR 300 & 600 TRAYS)

(EMTW-05-0505)

- Linear Waste Trap Kit
- Supplied with 2" - 1½" Reducer
- Vertical Elbow Adapter

£47.40



LINEAR 300 DRAIN COVER PLATE OPTIONS

DESCRIPTION	SIZE (mm)	FINISH	PRODUCT CODE	PRICE
LINEAR DRAIN STAINLESS STEEL COVER PLATE SUITS TILE & ADHESIVE THICKNESS 0-14mm	297 x 40	STAINLESS STEEL	EMTW-25-0505	£45.00
LINEAR DRAIN TILEABLE COVER PLATE SUITS TILE & ADHESIVE THICKNESS 8-25mm	297 x 40	TILEABLE	EMTW-25-0510	£69.00



LINEAR 600 DRAIN COVER PLATE OPTIONS

DESCRIPTION	SIZE (mm)	FINISH	PRODUCT CODE	PRICE
LINEAR DRAIN STAINLESS STEEL COVER PLATE SUITS TILE & ADHESIVE THICKNESS 0-14mm	597 x 40	STAINLESS STEEL	EMTW-25-1005	£89.00
LINEAR DRAIN TILEABLE COVER PLATE SUITS TILE & ADHESIVE THICKNESS 8-25mm	597 x 40	TILEABLE	EMTW-25-1010	£139.00



SHOWER TRAY INSTALLATION KIT

(EMAP-02-2505)

- For the installation and waterproofing of all shower trays
- Fix-KST Fixing Adhesive, Pro-SEAL (pre-mixed), Waterproofing Tape, Wood Floor Primer, Waterproofing Internal Corners, Protective Gloves

£99.60

Note: A standard Shower Tray Installation Kit contains 5kg Fix-KST fixing adhesive. This is suitable for approximately 2 square metres of screeded bedding. If you are bedding large shower trays with substrate elements eg. 1600 x 900mm please purchase additional Fix-KST as below:



FIX-KST FIXING ADHESIVE

- For adhering tray, sub-element or boards to any floor
- For adhering wall boards to a brick or block wall

(EMAS-05-0005) 5KG BAG

£17.50

(EMAS-05-0010) 20KG BAG

£59.00



WOOD FLOOR PRIMER

(TLTA-15-2005)

- To be used if you are fixing onto timber floors
- 1L Wood Floor Primer
- Covers approx. 10 sq. m

£22.50



Elements Bespoke Shower Trays

If the shower tray you require is not featured in our standard ranges, here at Abacus Elements we pride ourselves in the fast production of bespoke trays. Simply send a diagram or drawing of your requirements and we will provide you with a price and deliver your bespoke size shower tray in approximately 10 working days!



Why Bespoke Shower Trays?

ANY SIZE, ANY DRAIN POSITION* – 10 DAY DELIVERY

(*see following pages for details)

Although standard Elements shower trays can be cut up to a recommended distance of 80mm off either length or width, by doing this the depth of the perimeter of the tray will be altered, thereby affecting the fall (and drainage flow rate) of a standard shower tray.

That's why we recommend ordering a bespoke tray that is manufactured to your customised project dimensions, retaining the recommended fall and drainage flow for improved shower tray performance.

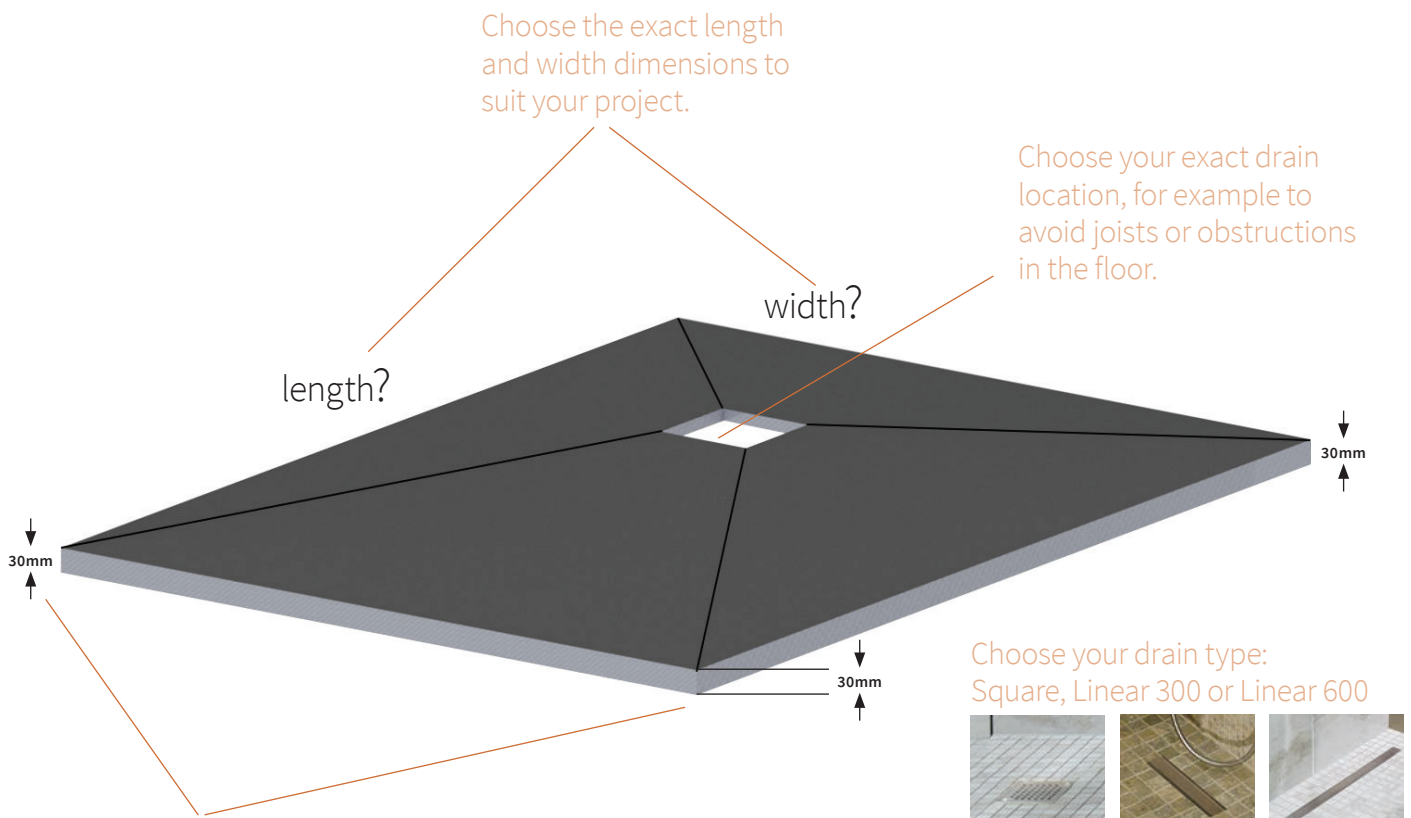

Choose the exact length and width dimensions to suit your project.

Choose your exact drain location, for example to avoid joists or obstructions in the floor.

length?

width?

30mm

30mm

30mm

Choose your drain type:
Square, Linear 300 or Linear 600



Even height all around the perimeter of the tray, with no need to 'cut' into the falls of the tray.

Fast, precise, automated manufacture and 10 day delivery.

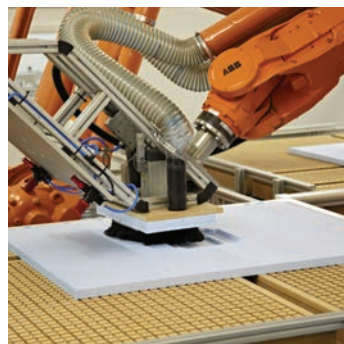

How to order your Elements Bespoke Shower Tray

Complete the online order form on our website at www.abacus-bathrooms.co.uk/bespoketray

FOR SQUARE OR RECTANGULAR-SHAPED BESPOKE TRAYS:

Simply give us the dimensions of your desired bespoke tray, drain type and drain position (see next page for drain location advice) and we'll send you your personalised bespoke tray technical drawing for approval.

Once signed-off, we produce your bespoke tray to your approved dimensions and deliver within 10 working days.

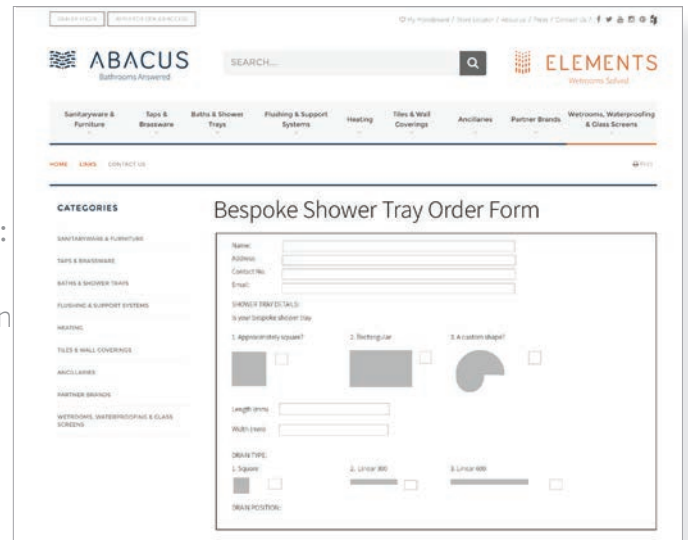
The image shows a screenshot of the ABACUS website's 'Bespoke Shower Tray Order Form'. The page has a clean, professional layout with a navigation menu at the top. The main content area is titled 'Bespoke Shower Tray Order Form' and contains several sections: 'Name', 'Address', 'Contact No.', and 'Email' fields; a 'SHOWER TRAY DETAILS' section with three options: '1. Approximately square', '2. Rectangular', and '3. A custom shape'; 'Length (mm)' and 'Width (mm)' input fields; a 'DRAIN TYPE' section with three options: '1. Square', '2. Linear 80', and '3. Linear 90'; and a 'DRAIN POSITION' section. A sidebar on the left lists various product categories like 'Sanitaryware & Furniture', 'Toys & Bathware', etc.

FOR CUSTOM-SHAPED BESPOKE TRAYS:

You simply can't beat the personal touch, so contact our sales office with a drawing and the dimensions of your custom-shaped bespoke tray. We'll input your design into our CAD system and produce your personalised bespoke tray technical drawing for approval.

Once signed-off, we produce your bespoke tray to your approved dimensions and deliver within 10 working days.

sales office: 0345 850 50 40



FREE DELIVERY OF YOUR BESPOKE SHOWER TRAY...IN JUST 10 DAYS FROM PLACING YOUR ORDER!

from approved technical drawings

SQUARE OR LINEAR DRAIN OPTIONS

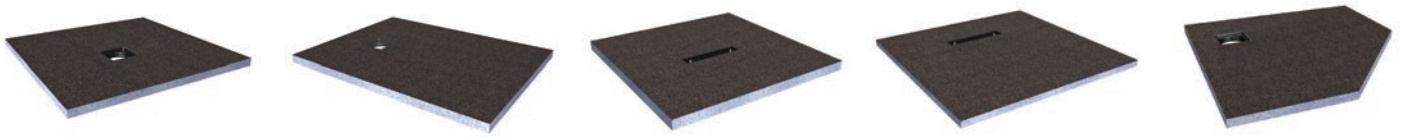

DRAIN TYPE AND LOCATION:

The choice is yours! Select the drain type you prefer, whether square, Linear 300 or Linear 600, and then decide on the location of the drain within the tray area. Check our handy guide below on drain placement:



Bespoke waste positions for Square Drains

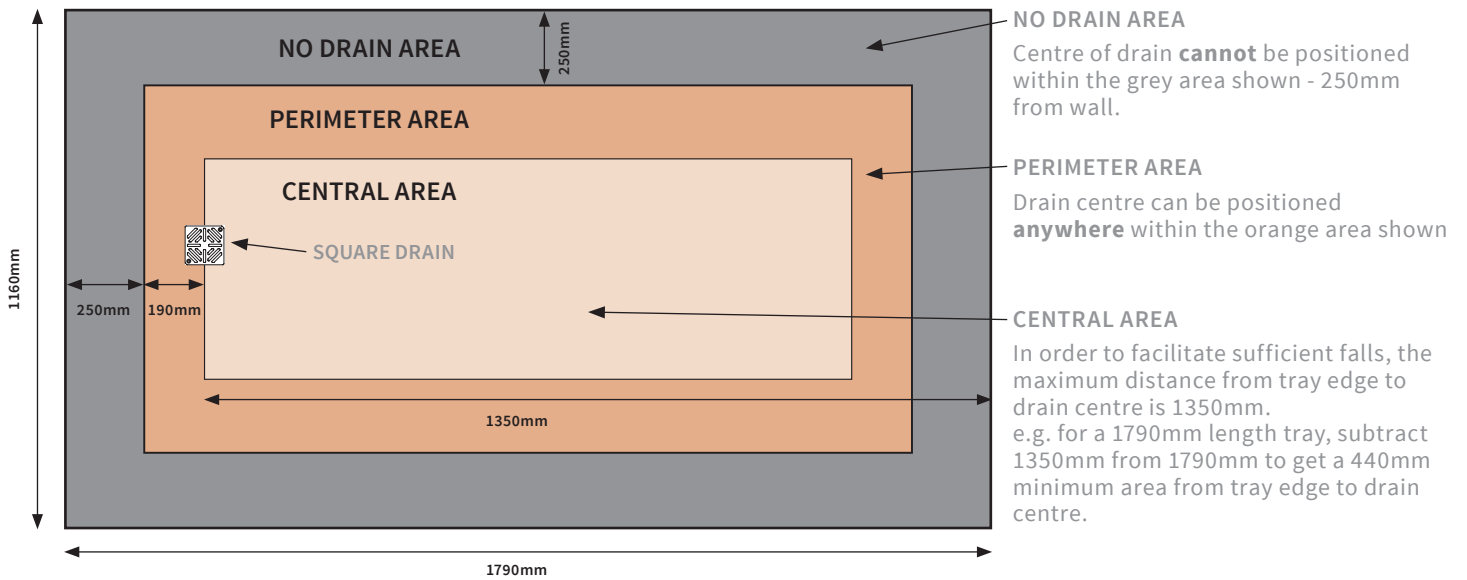

Bespoke waste positions for Linear Drains

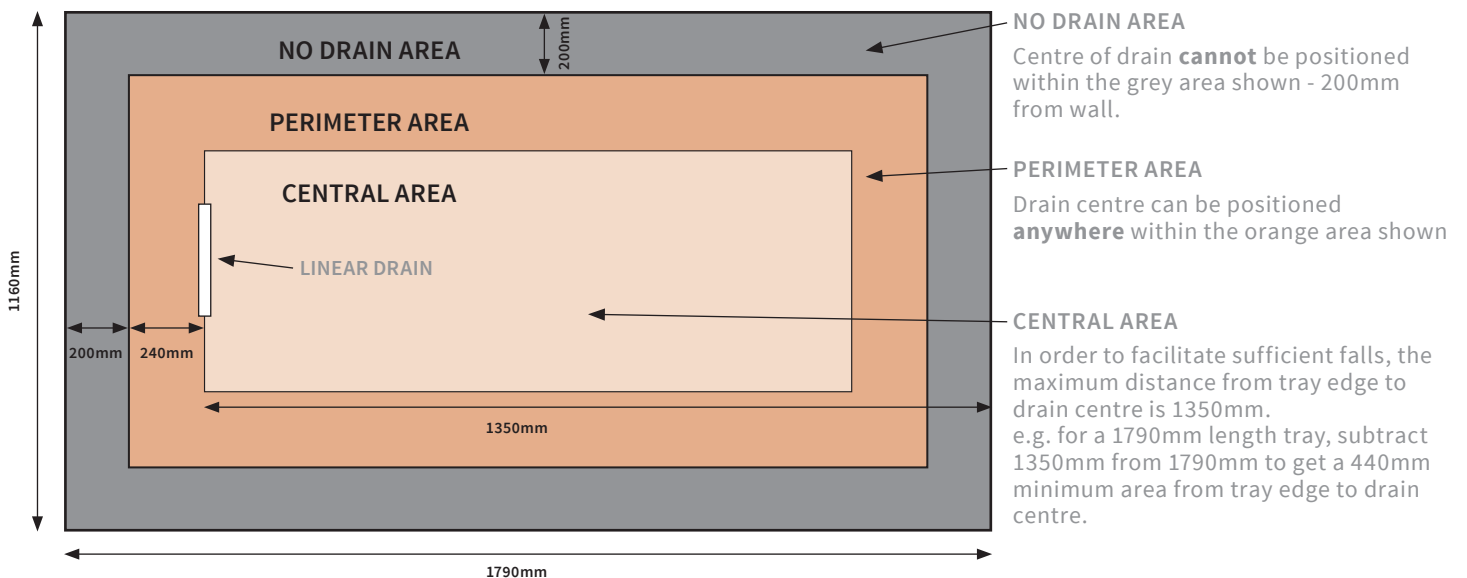

Bespoke Shower Trays - 30mm Height

LEVEL ACCESS - SQUARE DRAIN

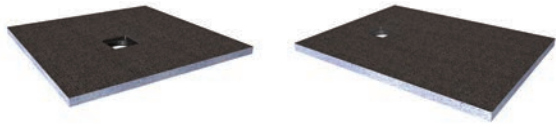

HOW TO ORDER:

1. Measure the length and width of the space you want the shower tray to fit.

Example: 960mm long x 1150mm wide will be EMST-93-1210 at £489 – see table below

2. Choose the drain position, (see examples on p.73). Remember there is a 250mm 'safe' area from the tray edges.

WIDTH OF SHOWER TRAY (mm)

		up to 1000	1001 to 1200	1201 to 1400	1401 to 1600	1601 to 1800
LENGTH OF SHOWER TRAY (mm)	up to 1000	£419 EMST-93-1010	£489 EMST-93-1210	£519 EMST-93-1410	£570 EMST-93-1610	£649 EMST-93-1810
	1001 to 1200	£489 EMST-93-1012	£534 EMST-93-1212	£570 EMST-93-1412	£649 EMST-93-1612	£699 EMST-93-1812
	1201 to 1400	£519 EMST-93-1014	£570 EMST-93-1214	£649 EMST-93-1414	£699 EMST-93-1614	£719 EMST-93-1814
	1401 to 1600	£570 EMST-93-1016	£649 EMST-93-1216	£699 EMST-93-1416	£719 EMST-93-1616	
	1601 to 1800	£649 EMST-93-1018	£699 EMST-93-1218	£719 EMST-93-1418		



ANY DRAIN POSITION

minimum 250mm from tray edge



CENTRALLY POSITIONED DRAIN

minimum 250mm from tray edge

ADDITIONAL ITEMS REQUIRED:

INSTALLATION KIT
(including square drain)
(EMAP-05-2505)

£180.00



OPTIONAL ITEMS:

DESIGNER SHOWER WASTE
Stainless Steel
(EMTW-25-0005)

£66.00



PLEASE NOTE:

For bespoke shower trays larger than 1400mm x 1400mm, or equivalent area, the following additional components from the installation kit are required to be purchased separately:

FIX-KST BOARD FIXING ADHESIVE 20kg

(EMAS-05-0010) **£59.00**

WATERPROOF TAPE - 10m ROLL

(EMTM-05-0010) **£49.20**

PRO-SEAL TAPE SEALING COMPOUND 1.2L

(EMAS-10-0015) **£43.80**



Bespoke Shower Trays - 40mm Height

SQUARE DRAIN

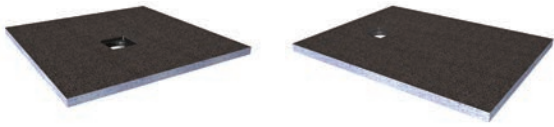

HOW TO ORDER:

1. Measure the length and width of the space you want the shower tray to fit.

Example: 960mm long x 1150mm wide will be EMST-94-1210 at £420 – see table below

2. Choose the drain position, (see examples on p.73). Remember there is a 250mm 'safe' area from the tray edges.

WIDTH OF SHOWER TRAY (mm)

	up to 1000	1001 to 1200	1201 to 1400	1401 to 1600	1601 to 1800	1801 to 2000	2001 to 2200
up to 1000	£360 EMST-94-1010	£420 EMST-94-1210	£480 EMST-94-1410	£520 EMST-94-1610	£550 EMST-94-1810	£599 EMST-94-2010	£699 EMST-94-2210
1001 to 1200	£420 EMST-94-1012	£449 EMST-94-1212	£520 EMST-94-1412	£550 EMST-94-1612	£599 EMST-94-1812	£699 EMST-94-2012	£749 EMST-94-2212
1201 to 1400	£480 EMST-94-1014	£520 EMST-94-1214	£560 EMST-94-1414	£599 EMST-94-1614	£699 EMST-94-1814	£749 EMST-94-2014	£799 EMST-94-2214
1401 to 1600	£520 EMST-94-1016	£550 EMST-94-1216	£599 EMST-94-1416	£699 EMST-94-1616	£749 EMST-94-1816	£799 EMST-94-2016	£849 EMST-94-2216
1601 to 1800	£550 EMST-94-1018	£599 EMST-94-1218	£699 EMST-94-1418	£749 EMST-94-1618	£799 EMST-94-1818	£849 EMST-94-2018	£899 EMST-94-2218
1801 to 2000	£599 EMST-94-1020	£699 EMST-94-1220	£749 EMST-94-1420	£799 EMST-94-1620	£849 EMST-94-1820	£899 EMST-94-2020	
2001 to 2200	£699 EMST-94-1022	£749 EMST-94-1222	£799 EMST-94-1422	£849 EMST-94-1622	£899 EMST-94-1822		

 ANY DRAIN POSITION minimum 250mm from tray edge

ADDITIONAL ITEMS REQUIRED:

INSTALLATION KIT
(including square drain)
(EMAP-05-2505)



£180.00

OPTIONAL ITEMS:

DESIGNER SHOWER WASTE
Stainless Steel
(EMTW-25-0005)



£66.00

PLEASE NOTE:

For bespoke shower trays larger than 1400mm x 1400mm, or equivalent area, the following additional components from the installation kit are required to be purchased separately:

FIX-KST BOARD FIXING ADHESIVE 20kg
(EMAS-05-0010) £59.00

WATERPROOF TAPE - 10m ROLL
(EMTM-05-0010) £49.20

PRO-SEAL TAPE SEALING COMPOUND 1.2L
(EMAS-10-0015) £43.80



Bespoke Shower Trays - 30mm Height

LEVEL ACCESS - LINEAR 300 DRAIN

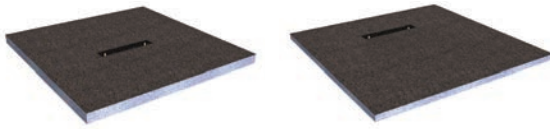

HOW TO ORDER:

1. Measure the length and width of the space you want the shower tray to fit.

Example: 960mm long x 1150mm wide will be EML3-93-1210 at £489 – see table below 

2. Choose the drain position, (see examples on p.73). Remember there is a 200mm 'safe' area from the tray edges.

WIDTH OF SHOWER TRAY (mm)

	up to 1000	1001 to 1200	1201 to 1400	1401 to 1600	1601 to 1800
up to 1000	£419 EML3-93-1010	£489 EML3-93-1210	£519 EML3-93-1410	£570 EML3-93-1610	£649 EML3-93-1810
1001 to 1200	£489 EML3-93-1012	£534 EML3-93-1212	£570 EML3-93-1412	£649 EML3-93-1612	£699 EML3-93-1812
1201 to 1400	£519 EML3-93-1014	£570 EML3-93-1214	£649 EML3-93-1414	£699 EML3-93-1614	£719 EML3-93-1814
1401 to 1600	£570 EML3-93-1016	£649 EML3-93-1216	£699 EML3-93-1416	£719 EML3-93-1616	
1601 to 1800	£649 EML3-93-1018	£699 EML3-93-1218	£719 EML3-93-1418		



ANY DRAIN POSITION
minimum 200mm from tray edge



CENTRALLY POSITIONED DRAIN
minimum 200mm from tray edge

ADDITIONAL ITEMS REQUIRED:

INSTALLATION KIT
(EMAP-05-2510)



£228.00

OPTIONAL ITEMS:

TILEABLE COVER PLATE
(EMTW-25-0510)



£69.00

PLEASE NOTE:

For bespoke shower trays larger than 1400mm x 1400mm, or equivalent area, the following additional components from the installation kit are required to be purchased separately:

FIX-KST BOARD FIXING ADHESIVE 20kg
(EMAS-05-0010) **£59.00**

WATERPROOF TAPE - 10m ROLL
(EMTM-05-0010) **£49.20**

PRO-SEAL TAPE SEALING COMPOUND 1.2L
(EMAS-10-0015) **£43.80**



Bespoke Shower Trays - 40mm Height

LINEAR 300 DRAIN

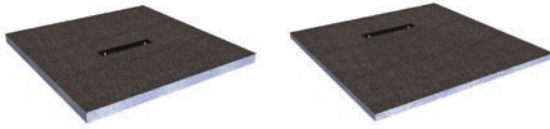

HOW TO ORDER:

1. Measure the length and width of the space you want the shower tray to fit.
Example: 960mm long x 1150mm wide will be EML3-94-1210 at £420 – see table below
2. Choose the drain position, (see examples on p.73). Remember there is a 200mm 'safe' area from the tray edges.

WIDTH OF SHOWER TRAY (mm)

	up to 1000	1001 to 1200	1201 to 1400	1401 to 1600	1601 to 1800	1801 to 2000	2001 to 2200
up to 1000	£360 EML3-94-1010	£420 EML3-94-1210	£480 EML3-94-1410	£520 EML3-94-1610	£550 EML3-94-1810	£599 EML3-94-2010	£699 EML3-94-2210
1001 to 1200	£420 EML3-94-1012	£449 EML3-94-1212	£520 EML3-94-1412	£550 EML3-94-1612	£599 EML3-94-1812	£699 EML3-94-2012	£749 EML3-94-2212
1201 to 1400	£480 EML3-94-1014	£520 EML3-94-1214	£560 EML3-94-1414	£599 EML3-94-1614	£699 EML3-94-1814	£749 EML3-94-2014	£799 EML3-94-2214
1401 to 1600	£520 EML3-94-1016	£550 EML3-94-1216	£599 EML3-94-1416	£699 EML3-94-1616	£749 EML3-94-1816	£799 EML3-94-2016	£849 EML3-94-2216
1601 to 1800	£550 EML3-94-1018	£599 EML3-94-1218	£699 EML3-94-1418	£749 EML3-94-1618	£799 EML3-94-1818	£849 EML3-94-2018	£899 EML3-94-2218
1801 to 2000	£599 EML3-94-1020	£699 EML3-94-1220	£749 EML3-94-1420	£799 EML3-94-1620	£849 EML3-94-1820	£899 EML3-94-2020	
2001 to 2200	£699 EML3-94-1022	£749 EML3-94-1222	£799 EML3-94-1422	£849 EML3-94-1622	£899 EML3-94-1822		

ANY DRAIN POSITION
minimum 200mm from tray edge

ADDITIONAL ITEMS REQUIRED:

INSTALLATION KIT
(EMAP-05-2510)



£228.00

OPTIONAL ITEMS:

TILEABLE COVER PLATE
(EMTW-25-0510)



£69.00

PLEASE NOTE:

For bespoke shower trays larger than 1400mm x 1400mm, or equivalent area, the following additional components from the installation kit are required to be purchased separately:

FIX-KST BOARD FIXING ADHESIVE 20kg
(EMAS-05-0010) £59.00

WATERPROOF TAPE - 10m ROLL
(EMTM-05-0010) £49.20

PRO-SEAL TAPE SEALING COMPOUND 1.2L
(EMAS-10-0015) £43.80



Bespoke Shower Trays - 30mm Height

LEVEL ACCESS - LINEAR 600 DRAIN



HOW TO ORDER:

1. Measure the length and width of the space you want the shower tray to fit.

Example: 960mm long x 1150mm wide will be EML6-93-1210 at £489 – see table below

2. Choose the drain position, (see examples on p.73). Remember there is a 200mm 'safe' area from the tray edges.

WIDTH OF SHOWER TRAY (mm)

		up to 1000	1001 to 1200	1201 to 1400	1401 to 1600	1601 to 1800
LENGTH OF SHOWER TRAY (mm)	up to 1000	£419 EML6-93-1010	£489 EML6-93-1210	£519 EML6-93-1410	£570 EML6-93-1610	£649 EML6-93-1810
	1001 to 1200	£489 EML6-93-1012	£534 EML6-93-1212	£570 EML6-93-1412	£649 EML6-93-1612	£699 EML6-93-1812
	1201 to 1400	£519 EML6-93-1014	£570 EML6-93-1214	£649 EML6-93-1414	£699 EML6-93-1614	£719 EML6-93-1814
	1401 to 1600	£570 EML6-93-1016	£649 EML6-93-1216	£699 EML6-93-1416	£719 EML6-93-1616	
	1601 to 1800	£649 EML6-93-1018	£699 EML6-93-1218	£719 EML6-93-1418		



ANY DRAIN POSITION
minimum 200mm from tray edge



CENTRALLY POSITIONED DRAIN
minimum 200mm from tray edge

ADDITIONAL ITEMS REQUIRED:

INSTALLATION KIT
(EMAP-05-2515)



£249.00

OPTIONAL ITEMS:

TILEABLE COVER PLATE
(EMTW-25-1010)



£139.00

PLEASE NOTE:

For bespoke shower trays larger than 1400mm x 1400mm, or equivalent area, the following additional components from the installation kit are required to be purchased separately:

FIX-KST BOARD FIXING ADHESIVE 20kg
(EMAS-05-0010) **£59.00**



WATERPROOF TAPE - 10m ROLL
(EMTM-05-0010) **£49.20**



PRO-SEAL TAPE SEALING COMPOUND 1.2L
(EMAS-10-0015) **£43.80**



Bespoke Shower Trays - 40mm Height

LINEAR 600 DRAIN

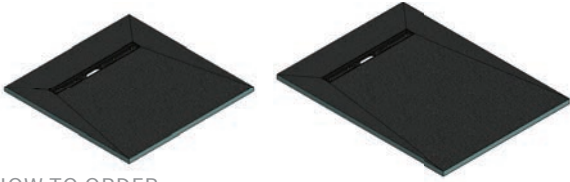

HOW TO ORDER:

1. Measure the length and width of the space you want the shower tray to fit.

Example: 960mm long x 1150mm wide will be EML6-94-1210 at £420 – see table below

2. Choose the drain position, (see examples on p.73). Remember there is a 200mm 'safe' area from the tray edges.

WIDTH OF SHOWER TRAY (mm)

	up to 1000	1001 to 1200	1201 to 1400	1401 to 1600	1601 to 1800	1801 to 2000	2001 to 2200
up to 1000	£360 EML6-94-1010	£420 EML6-94-1210	£480 EML6-94-1410	£520 EML6-94-1610	£550 EML6-94-1810	£599 EML6-94-2010	£699 EML6-94-2210
1001 to 1200	£420 EML6-94-1012	£449 EML6-94-1212	£520 EML6-94-1412	£550 EML6-94-1612	£599 EML6-94-1812	£699 EML6-94-2012	£749 EML6-94-2212
1201 to 1400	£480 EML6-94-1014	£520 EML6-94-1214	£560 EML6-94-1414	£599 EML6-94-1614	£699 EML6-94-1814	£749 EML6-94-2014	£799 EML6-94-2214
1401 to 1600	£520 EML6-94-1016	£550 EML6-94-1216	£599 EML6-94-1416	£699 EML6-94-1616	£749 EML6-94-1816	£799 EML6-94-2016	£849 EML6-94-2216
1601 to 1800	£550 EML6-94-1018	£599 EML6-94-1218	£699 EML6-94-1418	£749 EML6-94-1618	£799 EML6-94-1818	£849 EML6-94-2018	£899 EML6-94-2218
1801 to 2000	£599 EML6-94-1020	£699 EML6-94-1220	£749 EML6-94-1420	£799 EML6-94-1620	£849 EML6-94-1820	£899 EML6-94-2020	
2001 to 2200	£699 EML6-94-1022	£749 EML6-94-1222	£799 EML6-94-1422	£849 EML6-94-1622	£899 EML6-94-1822		

ANY DRAIN POSITION
minimum 200mm from tray edge

ADDITIONAL ITEMS REQUIRED:

INSTALLATION KIT
(EMAP-05-2515)



£249.00

OPTIONAL ITEMS:

TILEABLE COVER PLATE
(EMTW-25-1010)



£139.00

PLEASE NOTE:

For bespoke shower trays larger than 1400mm x 1400mm, or equivalent area, the following additional components from the installation kit are required to be purchased separately:

FIX-KST BOARD FIXING ADHESIVE 20kg
(EMAS-05-0010) **£59.00**

WATERPROOF TAPE - 10m ROLL
(EMTM-05-0010) **£49.20**

PRO-SEAL TAPE SEALING COMPOUND 1.2L
(EMAS-10-0015) **£43.80**



Bespoke Sub-Elements for 40mm Height Shower Trays

SQUARE DRAIN

Why do I need a sub-element?

If you are installing a raised wetroom shower tray where the waste trap needs to be above the floor level (for example a concrete floor that cannot be cut out), then the shower tray can be mounted onto an Elements foam sub-element which will raise the trap above the floor as shown in the diagram opposite. The waste pipe route can easily be cut into the sub-element using a hand saw.

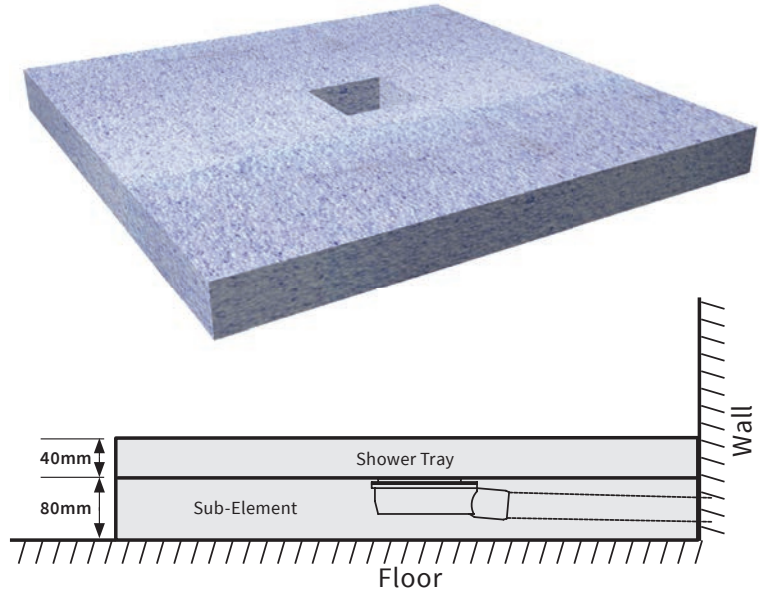

		WIDTH OF SHOWER TRAY (mm)						
		up to 1000	1001 to 1200	1201 to 1400	1401 to 1600	1601 to 1800	1801 to 2000	2001 to 2200
LENGTH OF SHOWER TRAY (mm)	up to 1000	£70 EMSE-96-1010	£83 EMSE-96-1210	£114 EMSE-96-1410	£126 EMSE-96-1610	£132 EMSE-96-1810	£190 EMSE-96-2010	£213 EMSE-96-2210
	1001 to 1200	£83 EMSE-96-1012	£114 EMSE-96-1212	£126 EMSE-96-1412	£132 EMSE-96-1612	£190 EMSE-96-1812	£213 EMSE-96-2012	£222 EMSE-96-2212
	1201 to 1400	£114 EMSE-96-1014	£126 EMSE-96-1214	£132 EMSE-96-1414	£190 EMSE-96-1614	£213 EMSE-96-1814	£222 EMSE-96-2014	£234 EMSE-96-2214
	1401 to 1600	£126 EMSE-96-1016	£132 EMSE-96-1216	£190 EMSE-96-1416	£213 EMSE-96-1616	£222 EMSE-96-1816	£234 EMSE-96-2016	£238 EMSE-96-2216
	1601 to 1800	£132 EMSE-96-1018	£190 EMSE-96-1218	£213 EMSE-96-1418	£222 EMSE-96-1618	£234 EMSE-96-1818	£238 EMSE-96-2018	£250 EMSE-96-2218
	1801 to 2000	£190 EMSE-96-1020	£213 EMSE-96-1220	£222 EMSE-96-1420	£234 EMSE-96-1620	£238 EMSE-96-1820	£250 EMSE-96-2020	
	2001 to 2200	£213 EMSE-96-1022	£222 EMSE-96-1222	£234 EMSE-96-1422	£238 EMSE-96-1622	£250 EMSE-96-1822		

PLEASE NOTE:

For bespoke shower trays larger than 1400mm x 1400mm, or equivalent area, the following additional components from the installation kit are required to be purchased separately:

FIX-KST BOARD FIXING ADHESIVE 5kg

(EMAS-05-0005) **£17.50**

FIX-KST BOARD FIXING ADHESIVE 20kg

(EMAS-05-0010) **£59.00**



Bespoke Sub-Elements for 40mm Height Shower Trays

LINEAR DRAIN

Why do I need a sub-element?

If you are installing a raised wetroom shower tray where the waste trap needs to be above the floor level (for example a concrete floor that cannot be cut out), then the shower tray can be mounted onto an Elements foam sub-element which will raise the trap above the floor as shown in the diagram opposite. The waste pipe route can easily be cut into the sub-element using a hand saw.

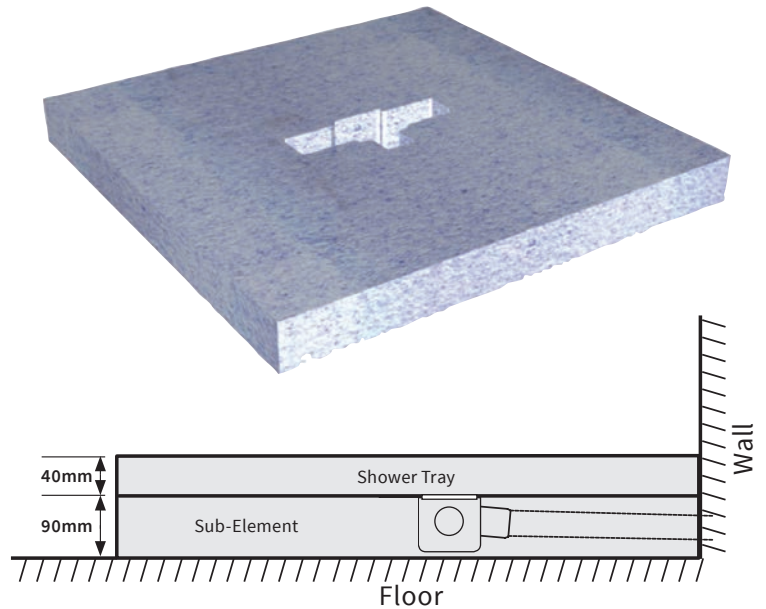

WIDTH OF SHOWER TRAY (mm)

	up to 1000	1001 to 1200	1201 to 1400	1401 to 1600	1601 to 1800	1801 to 2000	2001 to 2200
up to 1000	£70 EMSE-98-1010	£83 EMSE-98-1210	£114 EMSE-98-1410	£126 EMSE-98-1610	£132 EMSE-98-1810	£190 EMSE-98-2010	£213 EMSE-98-2210
1001 to 1200	£83 EMSE-98-1012	£114 EMSE-98-1212	£126 EMSE-98-1412	£132 EMSE-98-1612	£190 EMSE-98-1812	£213 EMSE-98-2012	£222 EMSE-98-2212
1201 to 1400	£114 EMSE-98-1014	£126 EMSE-98-1214	£132 EMSE-98-1414	£190 EMSE-98-1614	£213 EMSE-98-1814	£222 EMSE-98-2014	£234 EMSE-98-2214
1401 to 1600	£126 EMSE-98-1016	£132 EMSE-98-1216	£190 EMSE-98-1416	£213 EMSE-98-1616	£222 EMSE-98-1816	£234 EMSE-98-2016	£238 EMSE-98-2216
1601 to 1800	£132 EMSE-98-1018	£190 EMSE-98-1218	£213 EMSE-98-1418	£222 EMSE-98-1618	£234 EMSE-98-1818	£238 EMSE-98-2018	£250 EMSE-98-2218
1801 to 2000	£190 EMSE-98-1020	£213 EMSE-98-1220	£222 EMSE-98-1420	£234 EMSE-98-1620	£238 EMSE-98-1820	£250 EMSE-98-2020	
2001 to 2200	£213 EMSE-98-1022	£222 EMSE-98-1222	£234 EMSE-98-1422	£238 EMSE-98-1622	£250 EMSE-98-1822		

PLEASE NOTE:

For bespoke shower trays larger than 1400mm x 1400mm, or equivalent area, the following additional components from the installation kit are required to be purchased separately:

FIX-KST BOARD FIXING ADHESIVE 5kg

(EMAS-05-0005) **£17.50**

FIX-KST BOARD FIXING ADHESIVE 20kg

(EMAS-05-0010) **£59.00**



Bespoke Infinity Shower Trays - 30mm Height

LEVEL ACCESS - INFINITY

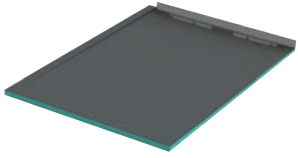

HOW TO ORDER:

1. Measure the length and width of the space you want the shower tray to fit.
Example: 960mm long x 1150mm wide will be EMIT-93-1210 at £649 (see pricing grids opposite)



INSTALLATION TYPES & SIZE OPTIONS:

First choose the type of installation for your level access Infinity tray.

1. LEFT HAND CORNER INSTALLATION = LC

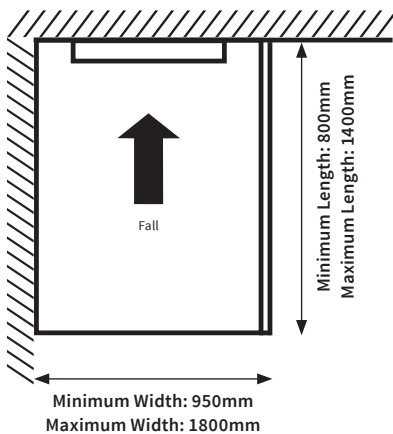

2. RIGHT HAND CORNER INSTALLATION = RC

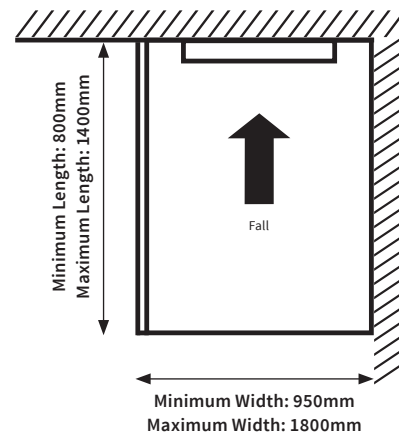

3. MID-WALL INSTALLATION = MW

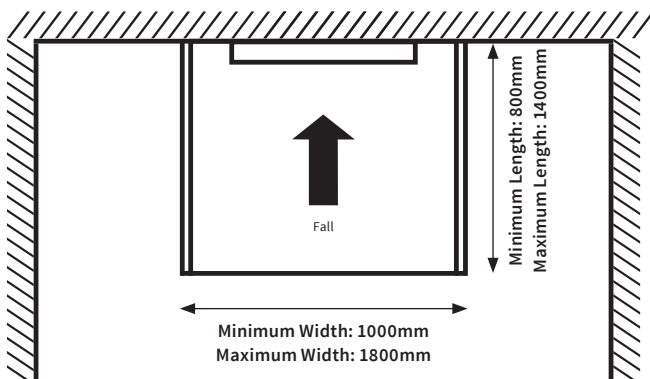

4. WALL-TO-WALL INSTALLATION = WW

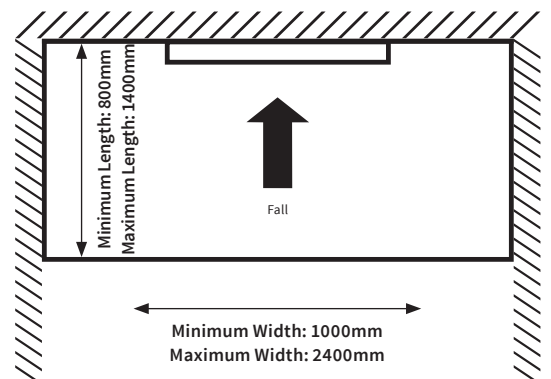

WIDTH OF SHOWER TRAY (mm)

1.		950 to 1200	1201 to 1400	1401 to 1600	1601 to 1800
LENGTH OF SHOWER TRAY (mm)	800 to 1000	£649 EMIT-93-1210LC	£689 EMIT-93-1410LC	£729 EMIT-93-1610LC	£799 EMIT-93-1810LC
	1001 to 1200	£689 EMIT-93-1212LC	£729 EMIT-93-1412LC	£799 EMIT-93-1612LC	£849 EMIT-93-1812LC
	1201 to 1400	£729 EMIT-93-1214LC	£799 EMIT-93-1414LC	£849 EMIT-93-1614LC	£899 EMIT-93-1814LC

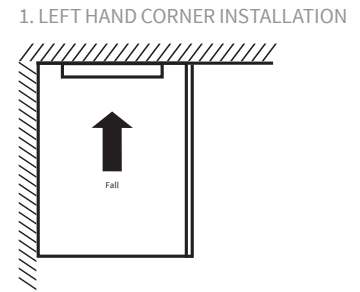

WIDTH OF SHOWER TRAY (mm)

2.		950 to 1200	1201 to 1400	1401 to 1600	1601 to 1800
LENGTH OF SHOWER TRAY (mm)	800 to 1000	£649 EMIT-93-1210RC	£689 EMIT-93-1410RC	£729 EMIT-93-1610RC	£799 EMIT-93-1810RC
	1001 to 1200	£689 EMIT-93-1212RC	£729 EMIT-93-1412RC	£799 EMIT-93-1612RC	£849 EMIT-93-1812RC
	1201 to 1400	£729 EMIT-93-1214RC	£799 EMIT-93-1414RC	£849 EMIT-93-1614RC	£899 EMIT-93-1814RC

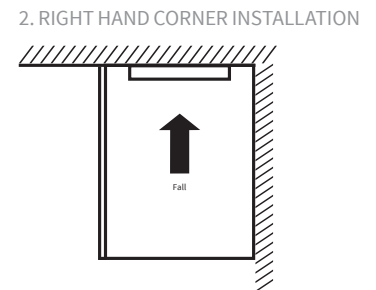

WIDTH OF SHOWER TRAY (mm)

3.		1000 to 1200	1201 to 1400	1401 to 1600	1601 to 1800
LENGTH OF SHOWER TRAY (mm)	800 to 1000	£699 EMIT-93-1210MW	£739 EMIT-93-1410MW	£779 EMIT-93-1610MW	£849 EMIT-93-1810MW
	1001 to 1200	£739 EMIT-93-1212MW	£779 EMIT-93-1412MW	£849 EMIT-93-1612MW	£899 EMIT-93-1812MW
	1201 to 1400	£779 EMIT-93-1214MW	£849 EMIT-93-1414MW	£899 EMIT-93-1614MW	£949 EMIT-93-1814MW

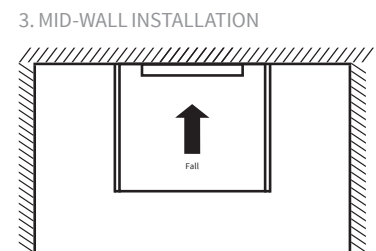

WIDTH OF SHOWER TRAY (mm)

4.		1000 to 1600	1601 to 1800	1801 to 2000	2001 to 2200	2201 to 2400
LENGTH OF SHOWER TRAY (mm)	800 to 1000	£779 EMIT-93-1610WW	£849 EMIT-93-1810WW	£899 EMIT-93-2010WW	£949 EMIT-93-2210WW	£999 EMIT-93-2410WW
	1001 to 1200	£849 EMIT-93-1612WW	£899 EMIT-93-1812WW	£949 EMIT-93-2012WW	£999 EMIT-93-2212WW	£1049 EMIT-93-2412WW
	1201 to 1400	£899 EMIT-93-1614WW	£949 EMIT-93-1814WW	£999 EMIT-93-2014WW	£1049 EMIT-93-2214WW	£1099 EMIT-93-2414WW

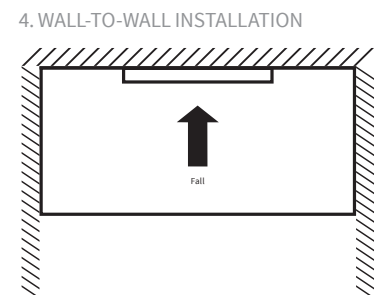

ADDITIONAL ITEMS REQUIRED:

INSTALLATION KIT

(EMAP-05-2520)

£229.00



All prices inclusive of VAT

Bespoke Shower Trays Custom Shapes

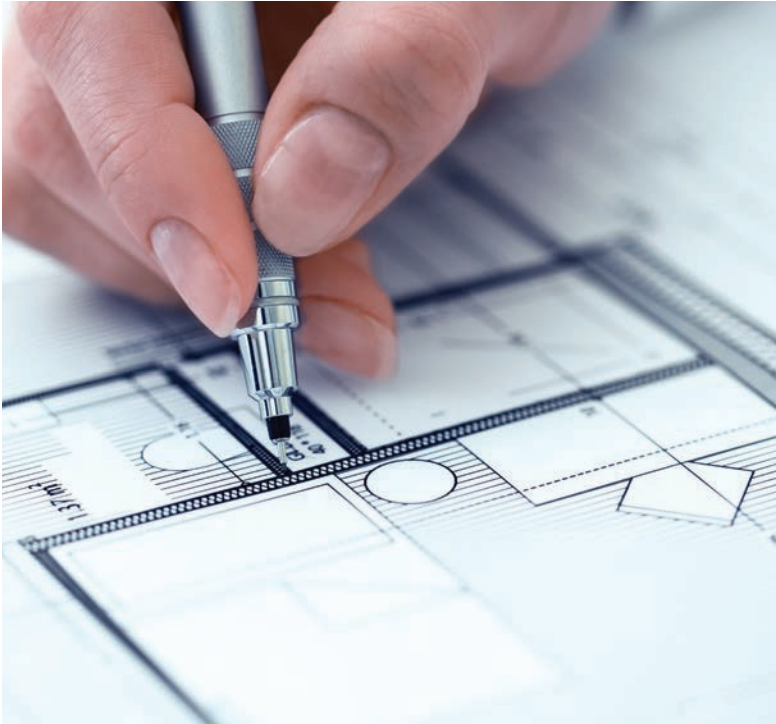

For Custom Shaped Bespoke Trays:

You simply can't beat the personal touch, so contact our sales office with a drawing and the dimensions of your custom-shaped bespoke tray. We'll input your design into our CAD system and produce your personalised bespoke tray technical drawing for approval.

Once signed-off, we produce your bespoke tray to your approved dimensions and deliver within 10 working days.

sales office: 0345 850 50 40





Elements Building Boards 6mm – 100mm



Kind to the environment



High compressive strength



Lightweight & easy to handle



Waterproof properties



Insulating properties



Easy to cut



Economical construction product

Features & benefits

- More stable in moist environments than timber
- Can be used for cladding walls and floors
- Can be used both internally and externally
- Can be either mechanically fixed, glued with Abacus Elements adhesive or both
- Cut easily with a hand saw to correct size, shape and around obstacles
- Good insulating product to help reduce condensation
- Offers higher adhesion to tiles than either timber or plasterboard
- Can be fixed onto almost any surface
- Has a high compressive strength of over 25 Tonnes per sq.m making it incredibly strong when tiled
- Can either be tiled or plastered
- A perfect product for the fast creation of tiled partition walls anywhere within the home
- Recommended for use with electric under tile heating systems



The most comprehensive wetroom and waterproofing system available in the UK.

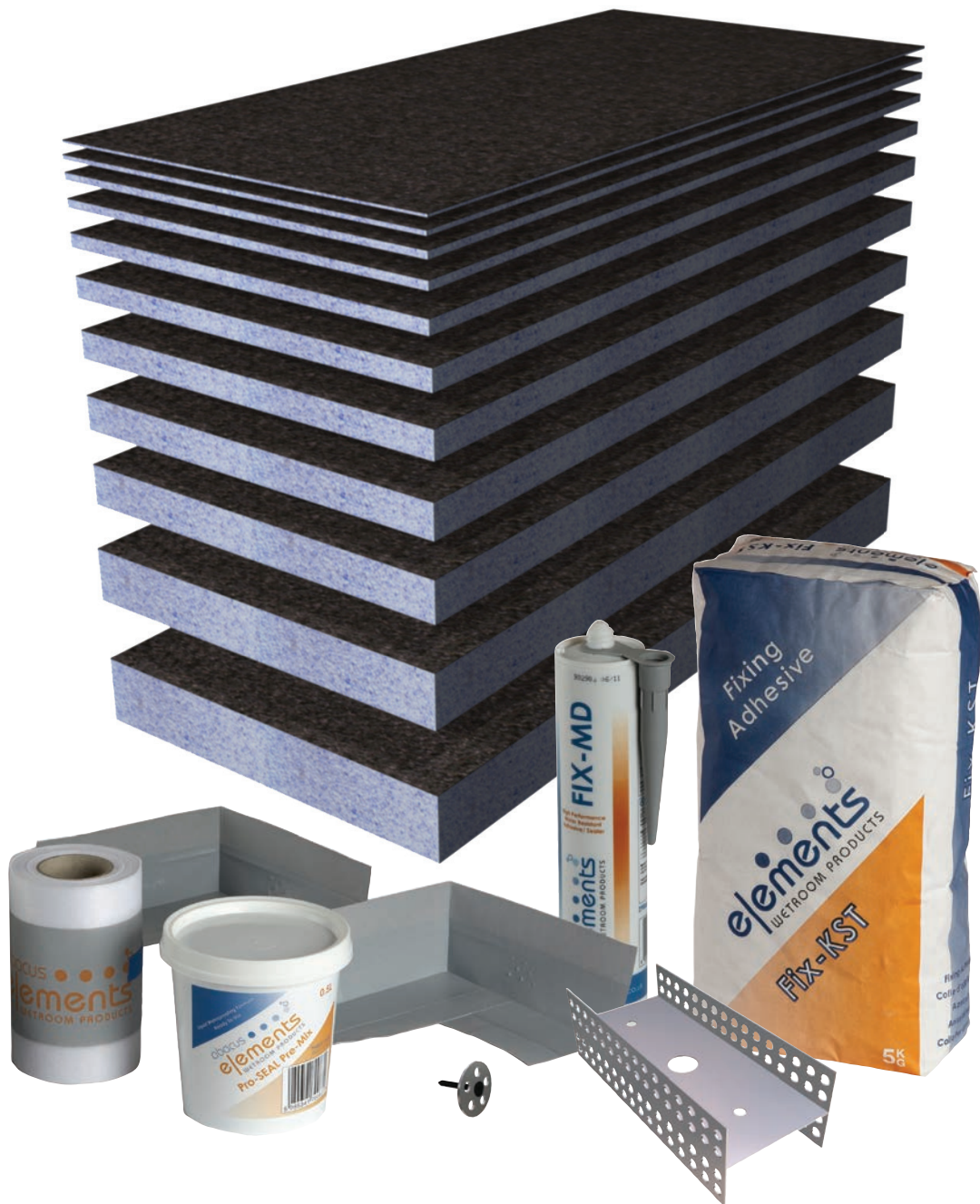

All backed with a 15 year guarantee.



Wall Panelling Kits

The professional's choice prior to tiling



WATERPROOF WALL KIT 1 - COVERAGE = 4.32 SQ.M

Kit includes:

- Six 1200 x 600 x 12mm/6mm waterproof boards
- Installation kit including fixings, waterproof tape, waterproofing adhesive and accessories

12mm BOARD KIT (FOR REPLACING PLASTERBOARD)

£199.00 (EMKB-12-1432)

6mm BOARD KIT (FOR OVERBOARDING EXISTING WALL)

£189.00 (EMKB-06-1432)

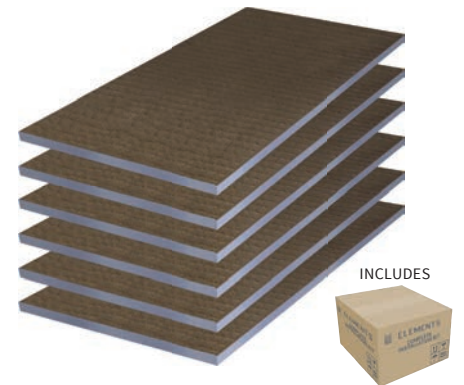

WATERPROOF WALL KIT 2 - COVERAGE = 5.76 SQ.M

Kit includes:

- Eight 1200 x 600 x 12mm/6mm waterproof boards
- Installation kit including fixings, waterproof tape, waterproofing adhesive and accessories

12mm BOARD KIT (FOR REPLACING PLASTERBOARD)

£249.00 (EMKB-12-2576)

6mm BOARD KIT (FOR OVERBOARDING EXISTING WALL)

£239.00 (EMKB-06-2576)

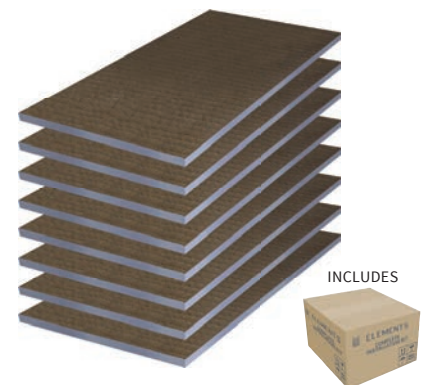

WATERPROOF WALL KIT 3 - COVERAGE = 7.20 SQ.M

Kit includes:

- Ten 1200 x 600 x 12mm/6mm waterproof boards
- Installation kit including fixings, waterproof tape, waterproofing adhesive and accessories

12mm BOARD KIT (FOR REPLACING PLASTERBOARD)

£289.00 (EMKB-12-3720)

6mm BOARD KIT (FOR OVERBOARDING EXISTING WALL)

£279.00 (EMKB-06-3720)

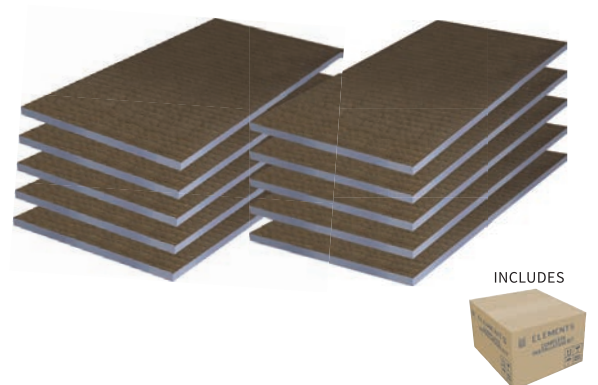

Wall and floor tile backer boards



TYPICAL WALL APPLICATIONS (INSIDE A SHOWER AREA)

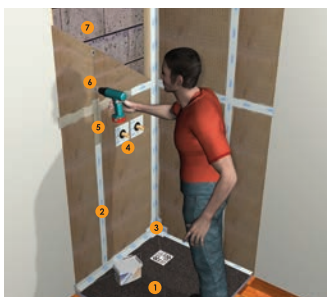

- 1 Abacus Elements shower tray
- 2 Abacus Elements waterproofing tape
- 3 Abacus Elements waterproofing corner
- 4 Abacus Elements waterproofing pipe sleeve
- 5 Abacus Elements Pro-SEAL waterproofing compound
- 6 Abacus Elements washer fixing
- 7 Typical timber stud work

TYPICAL FLOOR APPLICATIONS (OUTSIDE A SHOWER AREA)



- 1 Typical timber floor
- 2 Abacus Elements wood floor primer
- 3 Abacus Elements Fix-KST fixing adhesive
- 4 Abacus Elements 10mm backer board
- 5 Abacus Elements washer fixings
- 6 Abacus Elements non-waterproof, alkaline resistant joint reinforcing tape
- 7 Abacus Elements Fix-KST adhesive

600mm MINI/STANDARD WALL & FLOOR BOARD

DESCRIPTION	SIZE (mm)	PRODUCT CODE	PRICE
6mm MINI BOARD - FOR USE ON WALLS ONLY	1210 x 600 x 6	EMBO-05-1005	£27.90
10mm MINI BOARD	1210 x 600 x 10	EMBO-05-1505	£28.90
10mm STANDARD BOARD	2420 x 600 x 10	EMBO-05-1510	£58.50
12mm MINI BOARD	1210 x 600 x 12	EMBO-05-2005	£29.50
12mm STANDARD BOARD	2420 x 600 x 12	EMBO-05-2010	£59.50
20mm MINI BOARD	1210 x 600 x 20	EMBO-05-2503	£31.90
20mm STANDARD BOARD	2420 x 600 x 20	EMBO-05-2505	£63.90
30mm MINI BOARD	1210 x 600 x 30	EMBO-05-3003	£33.90
30mm STANDARD BOARD	2420 x 600 x 30	EMBO-05-3005	£67.90
40mm MINI BOARD	1210 x 600 x 40	EMBO-05-3503	£37.50
40mm STANDARD BOARD	2420 x 600 x 40	EMBO-05-3505	£74.90
50mm MINI BOARD	1210 x 600 x 50	EMBO-05-4003	£40.50
50mm STANDARD BOARD	2420 x 600 x 50	EMBO-05-4005	£81.00
60mm MINI BOARD	1210 x 600 x 60	EMBO-05-4503	£42.90
60mm STANDARD BOARD	2420 x 600 x 60	EMBO-05-4505	£84.90
80mm MINI BOARD	1210 x 600 x 80	EMBO-05-5003	£49.90
80mm STANDARD BOARD	2420 x 600 x 80	EMBO-05-5005	£99.80
100mm MINI BOARD	1210 x 600 x 100	EMBO-05-5503	£58.50
100mm STANDARD BOARD	2420 x 600 x 100	EMBO-05-5505	£117.00

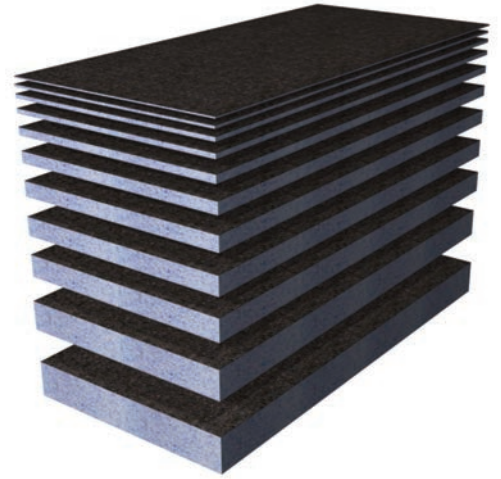

900mm WIDE WALL & FLOOR BOARD

DESCRIPTION	SIZE (mm)	PRODUCT CODE	PRICE
12mm WIDE MINI BOARD	1200 x 900 x 12	EMBO-20-2005	£47.70
12mm WIDE STANDARD BOARD*	2400 x 900 x 12	EMBO-20-2010	£95.40
20mm WIDE MINI BOARD	1200 x 900 x 20	EMBO-20-2505	£51.30
20mm WIDE STANDARD BOARD*	2400 x 900 x 20	EMBO-20-2510	£102.50
40mm WIDE MINI BOARD	1200 x 900 x 40	EMBO-20-3505	£70.80

*** Important Note -**

Wide standard board is only available in pallet quantities (50's) or on an ex-works basis (excluding carriage charges).



PRE-SLIT BOARD FOR CURVED WALLS

DESCRIPTION	SIZE (mm)	PRODUCT CODE	PRICE
30mm LONG SLIT BOARD FOR VERTICAL CURVES	2420 x 600 x 30	EMBO-10-3005	£134.40
MINI 30mm CROSS SLIT BOARD FOR HORIZONTAL CURVES	1210 x 600 x 30	EMBO-15-3003	£67.20
30mm CROSS SLIT BOARD FOR HORIZONTAL CURVES	2420 x 600 x 30	EMBO-15-3005	£134.40
80mm LONG SLIT BOARD FOR VERTICAL CURVES	2420 x 600 x 80	EMBO-10-5005	£191.40
MINI 80mm CROSS SLIT BOARD FOR HORIZONTAL CURVES	1210 x 600 x 80	EMBO-15-5003	£95.70
80mm CROSS SLIT BOARD FOR HORIZONTAL CURVES	2420 x 600 x 80	EMBO-15-5005	£191.40

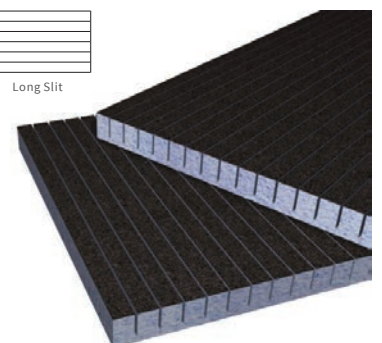
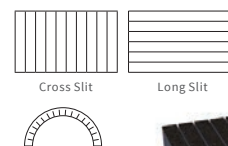

TYPICAL CURVED BOARD APPLICATION

- Can be used for
- Curved walls
 - Curved panels
 - P shaped baths

Building with Elements Board

Comprehensive waterproofing and insulation system for any bathroom, wetroom or steamroom, delivering ultimate build quality 'behind the tiles' for total peace of mind. Elements Board not only makes your bathroom last longer, thus protecting your investment, it also reduces mould – making it a much healthier option for any tiling project.

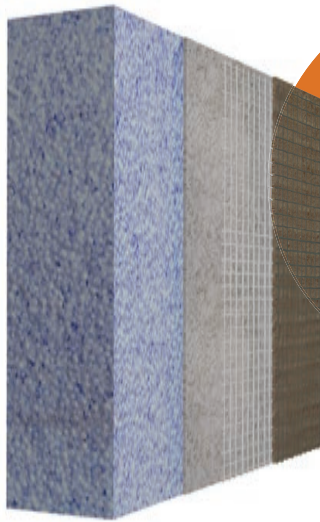

With a waterproof core and a special polymer cement coating, Elements board makes the perfect substrate for building in wet areas.

VERSATILE APPLICATIONS IN MULTIPLE THICKNESSES AND SIZES:

- 6mm board – to overboard a wall
- 10mm board – to overboard a floor instead of plywood
- 12mm board – an alternative to plasterboard
- 30mm board – to line a Steam Room (high levels of humidity)
- 80/100mm board – to form a stud wall

	Elements Boards	Plasterboard	Marine Ply
Insulating (reduces condensation and energy required to heat the room)	✓	✗	✗
Tile adhesion of up to 62kg per m²	✓	✗	✗
Anti-Mould properties (better for health)	✓	✗	✗
Lightweight, easy to cut & handle	✓	✗	✗
Waterproof (impervious to moisture & will not deform in damp atmospheric conditions)	✓	✗	✗



A 12mm WALL BOARDS

Perfect substrate for tiling; unlike plasterboard will insulate and waterproof - **page 89**

B PRO-SEAL JOINT SEALING TAPE AND ADHESIVE

For 100% waterproof joints and fixings - **page 105**

C SHOWER TRAY

A huge variety of wetroom shower trays and drains with pre-formed falls - **page 16-56**

D WALL PARTITION

Using Elements as a waterproof partition wall - **page 91**



**15
YEAR
GUARANTEE**

E RECESSED STORAGE UNIT

Fully waterproof and ready for installation - **page 96**

F TILEABLE BATH PANEL

Much faster to install than timber panelling, waterproof and stable in a moisture environment - **page 95**

G 10mm FLOOR BOARDS

Waterproof and insulate your bathroom floor using Elements Floor Backer Board; no more need for plywood - **page 40**

H JOINT REINFORCING TAPE

- for non waterproof joints

Insulate your bathroom and make it last much longer than traditional building methods - **page 107**

I BOARD FIXING ADHESIVE AND FIXINGS

Adhere and fix Elements boards to any substrate using Elements Fixings and KST Adhesive - **page 105**

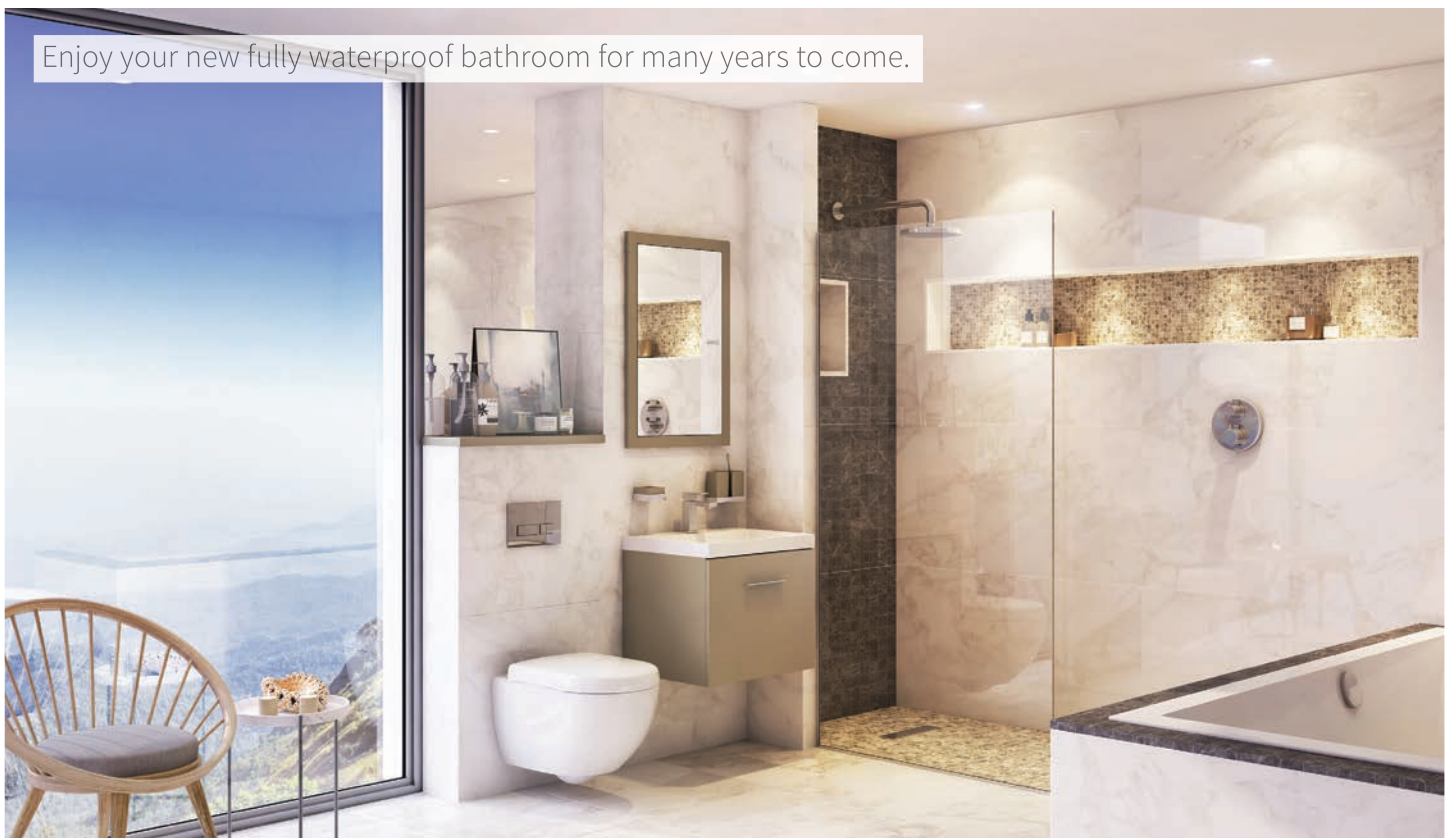

Tileable Bath Panels, Bath Steps & Accessories



STANDARD BATH FRONT PANELS

DESCRIPTION	SIZE (mm)	PRODUCT CODE	PRICE
STANDARD BATH FRONT PANEL FOR BATHS UP TO 1800mm	1795 x 600 x 30	EMBP-05-0005	£71.50
STANDARD BATH FRONT PANEL FOR BATHS UP TO 2050mm	2050 x 600 x 30	EMBP-05-0010	£95.00

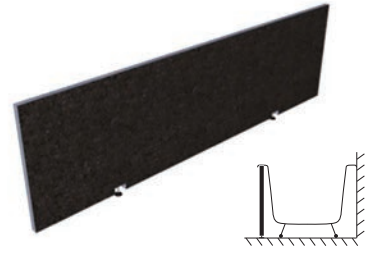

STANDARD BATH END PANELS

DESCRIPTION	SIZE (mm)	PRODUCT CODE	PRICE
STANDARD BATH END PANEL	805 x 600 x 30	EMBP-05-0015	£36.00

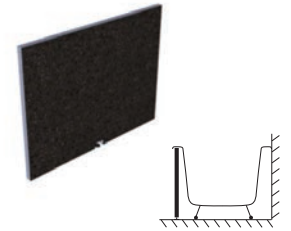

BATH FRONT PANEL WITH TILED LIP

DESCRIPTION	SIZE (mm)	PRODUCT CODE	PRICE
BATH FRONT PANEL WITH TILED LIP FOR BATHS UP TO 2050mm	2050 x 580 x 30	EMBP-10-0005	£108.00

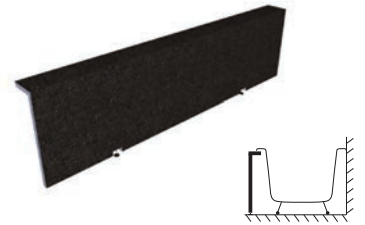

BATH END PANELS WITH TILED LIP

DESCRIPTION	SIZE (mm)	PRODUCT CODE	PRICE
BATH END PANEL WITH TILED LIP - LEFT HAND	905 x 580 x 30	EMBP-10-0010	£71.00
BATH END PANEL WITH TILED LIP - RIGHT HAND	905 x 580 x 30	EMBP-10-0015	£71.00

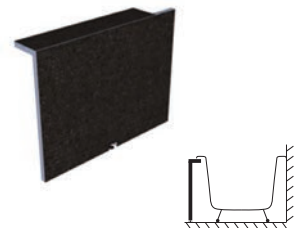

BATH PANEL MOUNTING KIT

DESCRIPTION	PRODUCT CODE	PRICE
BATH PANEL MOUNTING KIT INCLUDES 2 X FOAM STRIPS WITH FIXINGS	EMBP-15-0005	£9.50

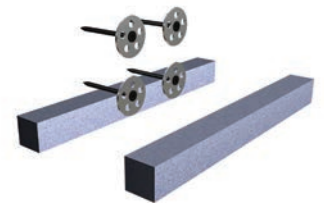

BATH STEP

DESCRIPTION	SIZE (mm)	PRODUCT CODE	PRICE
RAISED BATH STEP 200mm HEIGHT 300mm DEPTH	200 x 300	EMBP-20-0005	£159.00
PRICED PER LINEAR METER. (MADE TO LENGTH)			

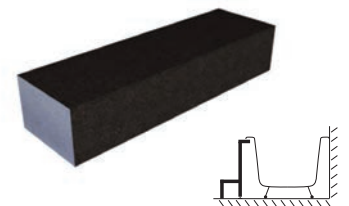

BESPOKE BATH PANELS

We are able to produce almost any tileable bath panel solution to your specific requirements. Simply supply us with your detailed specification and we will be pleased to quote you prices and delivery times.



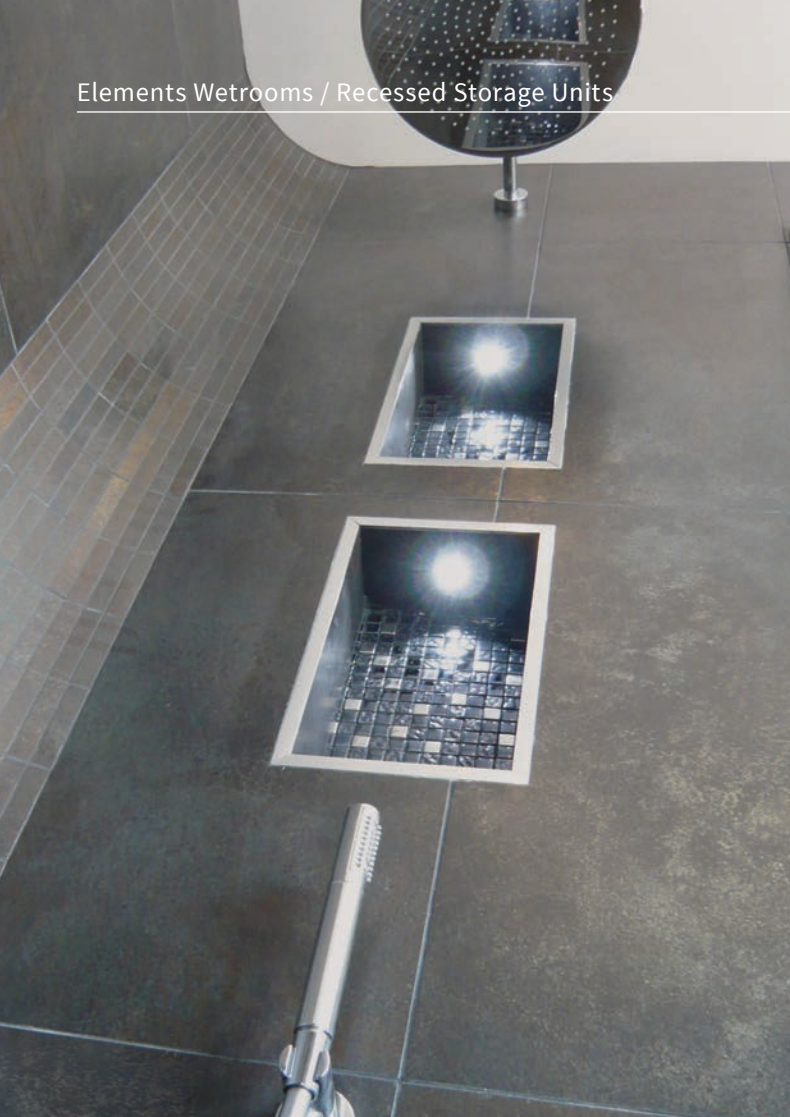

Ready To Tile Waterproof Recessed Storage Units

- Available in two depths, 100mm and 180mm
- Fully waterproof
- Ready to tile

15 year guarantee against leaks

Note 1: These units can be stacked on top of each other to form multiple recesses
Note 2: Units are easily installed using Fix-PU fixing adhesive

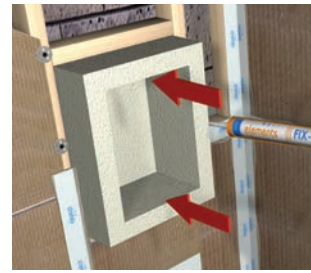

WATERPROOF RECESSED STORAGE UNITS - 350 x 240mm

DESCRIPTION	EXTERNAL SIZE (mm)	PRODUCT CODE	PRICE
SINGLE RECESSED WATERPROOF STORAGE UNIT - 100MM DEPTH	350 x 240 x 100	EMSU-05-0010	£114.00
SINGLE RECESSED WATERPROOF STORAGE UNIT - 180MM DEPTH	350 x 240 x 180	EMSU-05-0015	£118.00



WATERPROOF RECESSED STORAGE UNITS - 350 x 350mm

DESCRIPTION	EXTERNAL SIZE (mm)	PRODUCT CODE	PRICE
SINGLE RECESSED WATERPROOF STORAGE UNIT - 100MM DEPTH	350 x 350 x 100	EMSU-05-0020	£114.00
SINGLE RECESSED WATERPROOF STORAGE UNIT - 180MM DEPTH	350 x 350 x 180	EMSU-05-0025	£118.00



WATERPROOF RECESSED STORAGE UNITS - 420 x 350mm

DESCRIPTION	EXTERNAL SIZE (mm)	PRODUCT CODE	PRICE
SINGLE RECESSED WATERPROOF STORAGE UNIT - 100MM DEPTH	420 x 350 x 100	EMSU-05-0030	£132.00
SINGLE RECESSED WATERPROOF STORAGE UNIT - 180MM DEPTH	420 x 350 x 180	EMSU-05-0035	£138.00



WATERPROOF RECESSED STORAGE UNITS - 800 x 500mm

DESCRIPTION	EXTERNAL SIZE (mm)	PRODUCT CODE	PRICE
SINGLE RECESSED WATERPROOF STORAGE UNIT - 100MM DEPTH	800 x 500 x 100	EMSU-05-0550	£154.00
SINGLE RECESSED WATERPROOF STORAGE UNIT - 180MM DEPTH	800 x 500 x 180	EMSU-05-0555	£166.00



Recessed Storage



WATERPROOF RECESSED STORAGE UNITS - 350 x 1600mm

DESCRIPTION	EXTERNAL SIZE (mm)	PRODUCT CODE	PRICE
SINGLE RECESSED WATERPROOF STORAGE UNIT - 180MM DEPTH	350 x 1600 x 180	EMSU-05-0570	£226.00

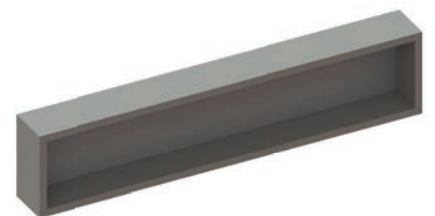

Bespoke units can be made to order



Ready To Tile Vanity Units

- Tileable vanity unit with shelf under
- Available in three sizes

750(h) x 800(w) x 600(d)mm (EMWS-05-0800)
£475.00

750(h) x 1200(w) x 600(d)mm (EMWS-05-1200)
£595.00

750(h) x 1600(w) x 600(d)mm (EMWS-05-1600)
£695.00



FEATURES & BENEFITS

- A much more professional finish than using timber
- Gives a waterproof sub-base to tiles
- Reduced installation time
- Ready to tile
- Easy to work with – can be cut with a hand saw



Tiled Benches

Made from Elements structural foam, these tileable benches are fully waterproof, supplied fully assembled, ready to tile and come with a 15 year guarantee.





Bespoke Vanity Units & Shelves

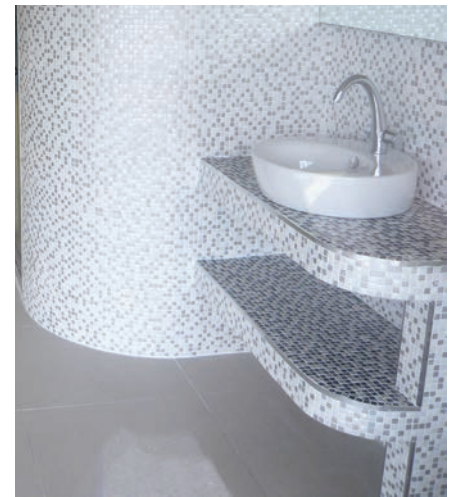

BESPOKE VANITY UNITS & SHELVES

DESCRIPTION	SIZE W x L x H (mm)	PRODUCT CODE	PRICE
BESPOKE TILEABLE VANITY UNIT	? x ? x ?	EMWS-95-0000	p.o.a

We are able to produce almost any bespoke shelves and vanity units to your specific requirements. Simply supply us with your detailed specification and we will be pleased to quote you prices and delivery times.

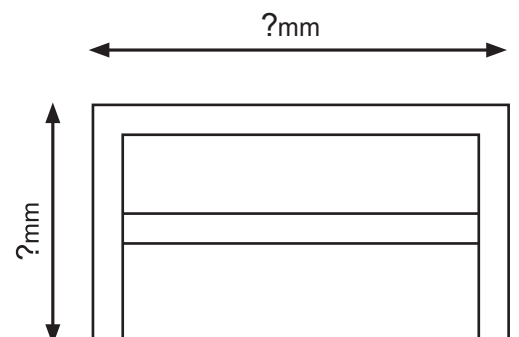

Pipe Boxing & Decor Trim Products

FEATURES & BENEFITS

- The fast and efficient way to box in pipes prior to tiling or rendering
- Can be either tiled or plastered
- Many shapes and sizes of pipe boxing available
- Greatly reduces installation time
- Gives a much better tiling surface than timber
- Reduces the need to plasterboard timber when applying render
- Waterproof and stable in a moist environment
- Can be used to create designs within a bathroom rather than just covering unsightly features



The easy and cost effective way to create tiled columns and rounded corners

ANGLED PIPE BOXING

DESCRIPTION	SIZE (mm)	PRODUCT CODE	PRICE
ANGLED PIPE BOXING 150 x 150mm	150 x 150 x 1210	EMPD-05-0005	£22.80
ANGLED PIPE BOXING 200 x 200mm	200 x 200 x 1210	EMPD-05-0010	£31.80
ANGLED PIPE BOXING 300 x 300mm	300 x 300 x 1210	EMPD-05-0015	£38.10
ANGLED PIPE BOXING 400 x 200mm	400 x 200 x 1210	EMPD-05-0020	£38.10



ANGULAR U PIPE BOXING

DESCRIPTION	SIZE (mm)	PRODUCT CODE	PRICE
ANGULAR U PIPE BOXING 200 x 200mm	200 x 200 x 1210	EMPD-05-0025	£47.10
ANGULAR U PIPE BOXING 400 x 200mm	400 x 200 x 1210	EMPD-05-0030	£58.80

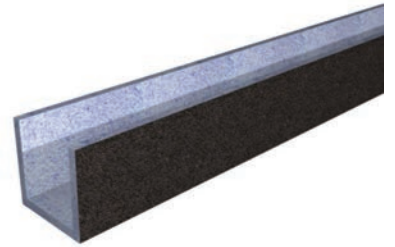

QUADRANT PIPE BOXING

DESCRIPTION	SIZE (mm)	PRODUCT CODE	PRICE
QUADRANT PIPE BOXING 150 x 150mm	150 x 150 x 1210	EMPD-05-0035	£51.00
QUADRANT PIPE BOXING 200 x 200mm	200 x 200 x 1210	EMPD-05-0040	£69.00
QUADRANT PIPE BOXING 300 x 300mm	300 x 300 x 1210	EMPD-05-0045	£105.00



ROUNDED U PIPE BOXING

DESCRIPTION	SIZE (mm)	PRODUCT CODE	PRICE
ROUNDED U PIPE BOXING 200 x 200mm	200 x 200 x 1210	EMPD-05-0050	£119.40



FLAT 45° PIPE BOXING

DESCRIPTION	SIZE (mm)	PRODUCT CODE	PRICE
FLAT 45° PIPE BOXING 300mm WITH 45° ANGLES	300 x 1210	EMPD-05-0055	£25.20
FLAT 45° PIPE BOXING 600mm WITH 45° ANGLES	600 x 1210	EMPD-05-0060	£37.80



INTERNAL RADIUS DECOR TRIM

DESCRIPTION	SIZE (mm)	PRODUCT CODE	PRICE
INTERNAL RADIUS DECOR TRIM 105mm RADIUS	1210, radius = 105	EMPD-10-0005	£18.00
INTERNAL RADIUS DECOR TRIM 205mm RADIUS	1210, radius = 205	EMPD-10-0010	£36.00
INTERNAL RADIUS DECOR TRIM 500mm RADIUS	1210, radius = 500	EMPD-10-0050	£140.00



ROUNDED CORNER ELEMENT

DESCRIPTION	SIZE (mm)	PRODUCT CODE	PRICE
ROUNDED CORNER ELEMENT 125mm DIAMETER	125 dia. x 1210	EMPD-10-0015	£33.00
ROUNDED CORNER ELEMENT 205mm DIAMETER	205 dia. x 1210	EMPD-10-0020	£57.00

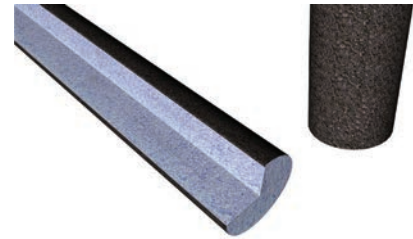

FINISHING COLUMN - FOR 80mm WALLS

DESCRIPTION	SIZE (mm)	PRODUCT CODE	PRICE
FINISHING COLUMN FOR 80mm WALLS 125mm DIAMETER	125 dia. x 1210	EMPD-10-0025	£57.00



FULL DECORATIVE COLUMN - 250mm DIAMETER

DESCRIPTION	SIZE (mm)	PRODUCT CODE	PRICE
FULL DECORATIVE COLUMN 250mm DIAMETER	250 dia. x 2420	EMPD-10-0030	£234.00



HALF DECORATIVE COLUMN - 250mm DIAMETER

DESCRIPTION	SIZE (mm)	PRODUCT CODE	PRICE
HALF DECORATIVE COLUMN 250mm DIAMETER	250 dia. x 1210	EMPD-10-0035	£59.40



QUARTER DECORATIVE COLUMN - 250mm DIAMETER

DESCRIPTION	SIZE (mm)	PRODUCT CODE	PRICE
QUARTER DECORATIVE COLUMN 250mm DIAMETER	250 dia. x 1210	EMPD-10-0040	£35.40

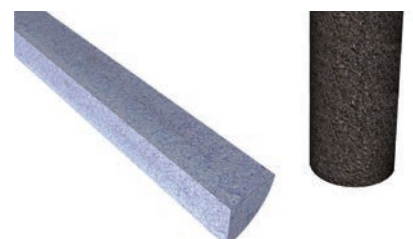



Fixings, Adhesives & Sealing Components

- Board fixing adhesives
- Waterproofing adhesives
- Wood floor primer
- Board fixings
- Mounting accessories
- Joint reinforcing tapes and mats



Fixings

35mm WASHER FIXINGS

DESCRIPTION	PRODUCT CODE	PRICE
35mm FIXING WASHER ONLY (50) PACK OF 50 UNITS	EMFC-05-0005	£13.20
35mm FLOOR FIXING WASHER WITH 25mm SCREW (50) PACK OF 50 UNITS	EMFC-05-0010	£14.90
35mm WALL FIXING WASHER WITH 45mm SCREW (50) PACK OF 50 UNITS	EMFC-05-0015	£15.60
35mm FIXING WASHER WITH 80mm SCREW (25) PACK OF 25 UNITS	EMFC-05-0020	£8.90
35mm FIXING WASHER BULK BOX OF 1000 UNITS (WASHER ONLY, NO SCREWS)	EMFC-05-0040	£200.00



**BULK BUY
1000 PACK**

70mm WASHER FIXINGS

DESCRIPTION	PRODUCT CODE	PRICE
70mm FIXING WASHER ONLY (25) BOX OF 25 UNITS	EMFC-05-0030	£11.40
70mm FIXING WASHER WITH 80mm SCREW (25) BOX OF 25 UNITS	EMFC-05-0035	£13.80



Adhesives

FIX-KST BOARD FIXING ADHESIVE

DESCRIPTION	SIZE (mm)	PRODUCT CODE	PRICE
FIX-KST BOARD FIXING ADHESIVE - 5KG BAG	N/A	EMAS-05-0005	£17.50
FIX-KST BOARD FIXING ADHESIVE - 20KG BAG	N/A	EMAS-05-0010	£59.00



FIX-MD SEALING & MOUNTING ADHESIVE

DESCRIPTION	SIZE (mm)	PRODUCT CODE	PRICE
FIX-MD SEALING & MOUNTING ADHESIVE 310ML CARTRIDGE	N/A	EMAS-15-0005	£18.50



WOOD FLOOR PRIMER

DESCRIPTION	SIZE (mm)	PRODUCT CODE	PRICE
WOOD FLOOR PRIMER - 1L	N/A	TLTA-15-2005	£22.50

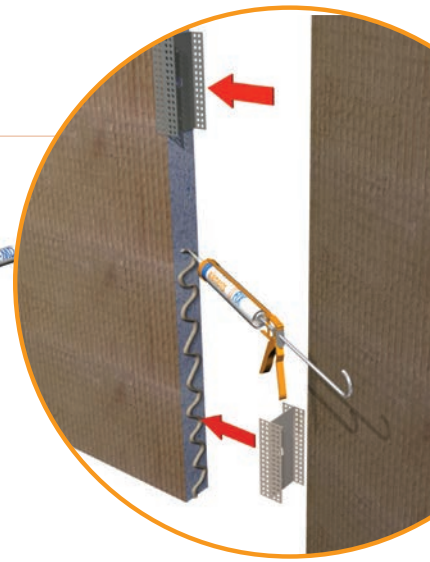

Waterproofing

WATERPROOFING TAPE - 120mm WIDTH

DESCRIPTION	SIZE (mm)	PRODUCT CODE	PRICE
WATERPROOF TAPE - 5m ROLL	120mm x 5m	EMTM-05-0005	£24.60
WATERPROOF TAPE - 10m ROLL	120mm x 10m	EMTM-05-0010	£49.20
WATERPROOF TAPE - 50m ROLL	120mm x 50m	EMTM-05-0015	£189.00



WATERPROOFING CORNERS

DESCRIPTION	SIZE (mm)	PRODUCT CODE	PRICE
WATERPROOF INTERNAL CORNER	N/A	EMTM-50-0005	£8.80
WATERPROOF EXTERNAL CORNER	N/A	EMTM-50-0010	£8.80



WATERPROOF PIPE SLEEVES

DESCRIPTION	SIZE (mm)	PRODUCT CODE	PRICE
WATERPROOF PIPE SLEEVE 100mm x 100mm FOR PIPE SIZES 12 - 20mm	100 x 100	EMTM-75-0005	£9.50
WATERPROOF PIPE SLEEVE 150mm x 150mm FOR PIPE SIZES 20 - 50mm	150 x 150	EMTM-75-0010	£11.75
WATERPROOF PIPE SLEEVE 200mm x 200mm FOR PIPE SIZES 50 - 70mm	200 x 200	EMTM-75-0015	£18.60
WATERPROOF PIPE SLEEVE 200mm x 200mm FOR PIPE SIZES 70 - 110mm	200 x 200	EMTM-75-0020	£22.20

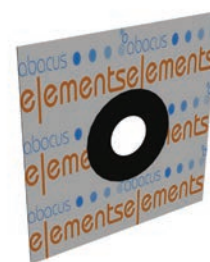

PRO-SEAL PREMIX - WATERPROOF TAPE SEALING COMPOUND

DESCRIPTION	SIZE (mm)	PRODUCT CODE	PRICE
PRO-SEAL PREMIX TAPE SEALING COMPOUND 0.5L	N/A	EMAS-10-0013	£23.50
PRO-SEAL PREMIX TAPE SEALING COMPOUND 1.2L	N/A	EMAS-10-0015	£43.80



Waterproofing



SELF ADHESIVE WATERPROOFING TAPE - FOR ACRYLIC SHOWER TRAYS AND BATHS

DESCRIPTION	SIZE (mm)	PRODUCT CODE	PRICE
SELF ADHESIVE WATERPROOF TAPE - 80mm x 5m ROLL	80mm x 5m	EMTM-10-0005	£45.00
SELF ADHESIVE WATERPROOF TAPE - 80mm x 50m ROLL	80mm x 50m	EMTM-10-0015	£354.00



SELF ADHESIVE WATERPROOFING CORNER - FOR ACRYLIC SHOWER TRAYS AND BATHS

DESCRIPTION	SIZE (mm)	PRODUCT CODE	PRICE
SELF ADHESIVE WATERPROOF CORNER - INTERNAL	N/A	EMTM-55-0005	£14.90

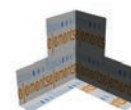

Construction

BOARD FIXING SCREWS

DESCRIPTION	SIZE (mm)	PRODUCT CODE	PRICE
130mm BOARD TO BOARD SCREW	N/A	EMFC-15-0010	£0.90



STRENGTHENING INSERT

DESCRIPTION	SIZE (mm)	PRODUCT CODE	PRICE (per linear metre)
STRENGTHENING INSERT PER LINEAR METRE	60 x 8	EMFC-55-0005	£66.00

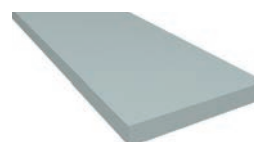

Construction

MOUNTING AIDS

DESCRIPTION	SIZE (mm)	PRODUCT CODE	PRICE
STRAIGHT MOUNTING AID 50mm	N/A	EMFC-50-0005	£3.40
STRAIGHT MOUNTING AID 80mm	N/A	EMFC-50-0010	£3.40
DESCRIPTION	SIZE (mm)	PRODUCT CODE	PRICE
90° ANGLE MOUNTING AID 50mm	N/A	EMFC-50-0015	£6.60
90° ANGLE MOUNTING AID 80mm	N/A	EMFC-50-0020	£6.60
DESCRIPTION	SIZE (mm)	PRODUCT CODE	PRICE
TEE PIECE MOUNTING AID 50mm	N/A	EMFC-50-0025	£6.60
TEE PIECE MOUNTING AID 80mm	N/A	EMFC-50-0030	£6.60
DESCRIPTION	SIZE (mm)	PRODUCT CODE	PRICE
CONNECTION MOUNTING AID 50mm	N/A	EMFC-50-0035	£7.80
CONNECTION MOUNTING AID 80mm	N/A	EMFC-50-0040	£7.80

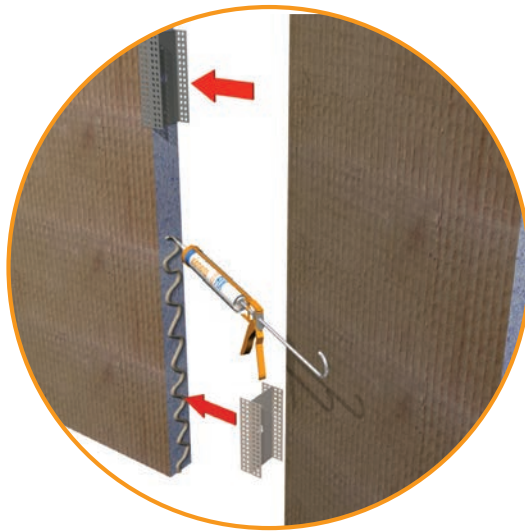

FIX-MD SEALING & MOUNTING ADHESIVE

DESCRIPTION	SIZE (mm)	PRODUCT CODE	PRICE
FIX-MD SEALING & MOUNTING ADHESIVE 310ML CARTRIDGE	N/A	EMAS-15-0005	£18.50



JOINT REINFORCING TAPE - ALKALINE RESISTANT

DESCRIPTION	SIZE (mm)	PRODUCT CODE	PRICE
JOINT REINFORCING TAPE - ALKALINE RESISTANT 100mm WIDTH X 20m ROLL	100mm x 20m	EMTM-15-0005	£13.80
JOINT REINFORCING TAPE - ALKALINE RESISTANT 100mm WIDTH X 90m ROLL	100mm x 90m	EMTM-15-0010	£54.00

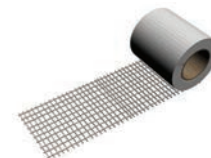

REINFORCEMENT MAT - ALKALINE RESISTANT

DESCRIPTION	SIZE (mm)	PRODUCT CODE	PRICE
SURFACE REINFORCING MAT - ALKALINE RESISTANT 595MM WIDTH X 20M ROLL	595mm x 20m	EMTM-35-0005	£29.90
SURFACE REINFORCING MAT - ALKALINE RESISTANT 595MM WIDTH X 150M ROLL	595mm x 150m	EMTM-35-0010	£216.00
SURFACE REINFORCING MAT - ALKALINE RESISTANT 895MM WIDTH X 100M ROLL	895mm x 100m	EMTM-35-0015	£216.00

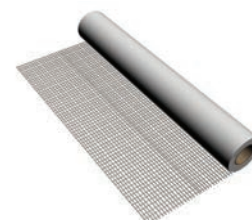

All prices inclusive of VAT

Standard Shower Seat

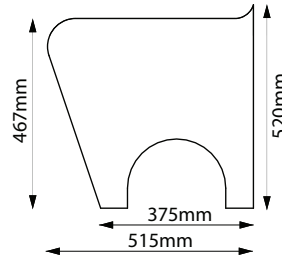
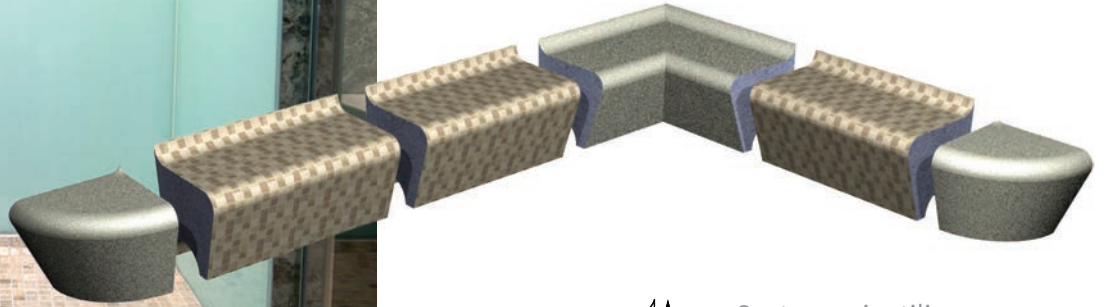

Seats require tiling in mosaic tiles with a maximum individual tile size of 35 x 35mm.

Suitable for electric under-tile heating.

Bespoke seats can be made to order.

STANDARD SHOWER SEAT

DESCRIPTION	SIZE (mm)	PRODUCT CODE	PRICE
STANDARD SHOWER SEAT 1m LENGTH	1000 x 515 x 520	EMSC-80-1005	£394.00

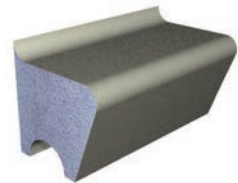

INTERNAL MITRE CUT SECTION

DESCRIPTION	SIZE (mm)	PRODUCT CODE	PRICE
INTERNAL MITRE CUT SECTION - 700 x 700mm	700 x 700 x 520	EMSC-80-1010	£594.00

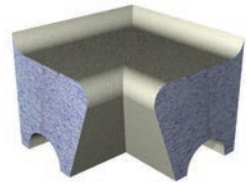

INTERNAL ROUND SECTION

DESCRIPTION	SIZE (mm)	PRODUCT CODE	PRICE
INTERNAL ROUND SECTION - 700 x 700mm SUPPLIED WITH INFILL PIECE	700 x 700 x 520	EMSC-80-1015	£588.00

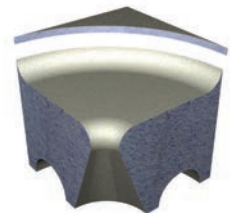

EXTERNAL ROUND SECTION

DESCRIPTION	SIZE (mm)	PRODUCT CODE	PRICE
EXTERNAL ROUND SECTION	515 x 515 x 520	EMSC-80-1020	£540.00

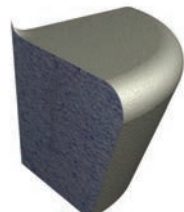

Shower Seating





Complete Shower Cubicles



Penta 1 Shower Cubicle

TYPICAL PENTA 1 ROOM LAYOUT

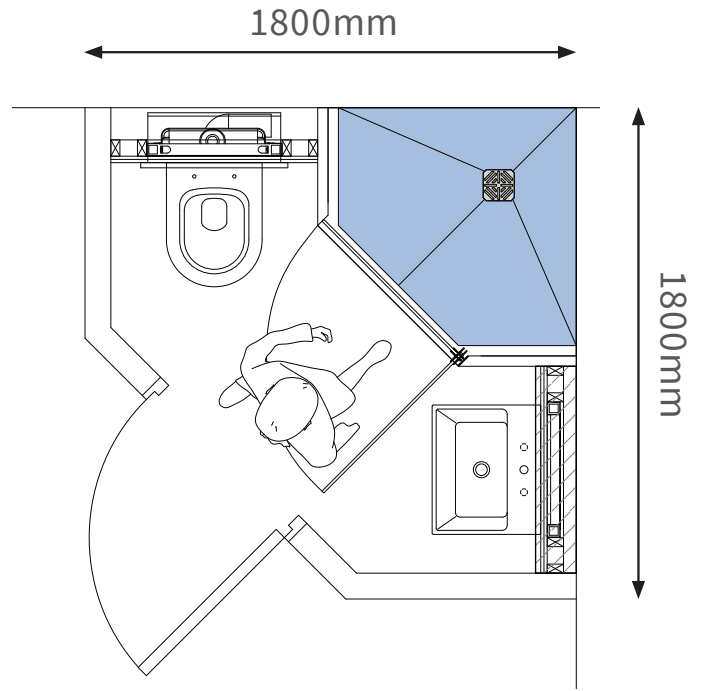

SPECIAL SUBSTRATE ELEMENT INCLUDED

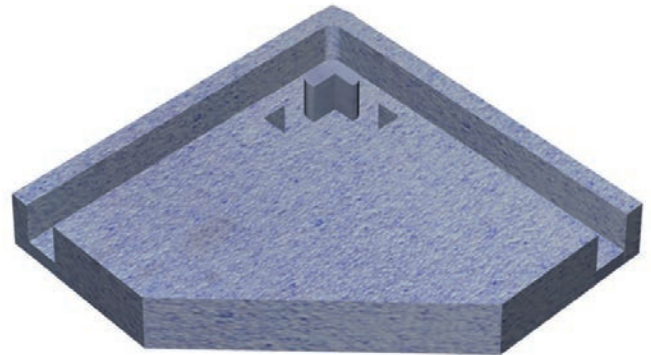

The Penta 1 Cubicle is supplied complete with a specially developed Substrate Element. The Substrate Element incorporates drainage channels to allow pipework to be installed between the two solid walls.

SUPPLIED WITH



Full Installation & Drainage Kit



PENTA 1 CUBICLE - 1000 x 1000mm

DESCRIPTION	SIZE (mm)	PRODUCT CODE	PRICE
PENTA 1 CUBICLE - 1000 x 1000mm INC. FULL INSTALLATION & DRAINAGE KIT	2616 x 1000 x 1000	EMSC-05-0505	£1,599.00

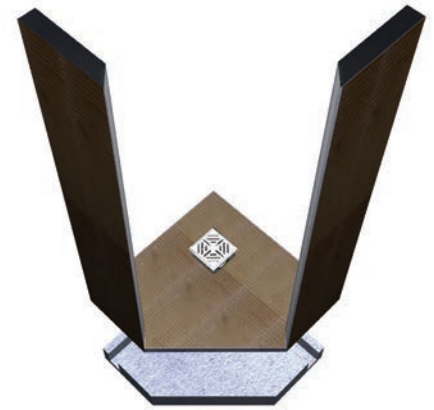

PENTA 1 CUBICLE - FRAMELESS GLASS DOOR

DESCRIPTION	SIZE (mm)	PRODUCT CODE	PRICE
PENTA CUBICLE FRAMELESS GLASS DOOR	1900 x 745 x 8	VEGX-15-1305	£399.00

- Frameless glass shower door 8mm supplied with 2 chrome hinges
- Door suits L & R opening
- Note: These shower doors are not designed to be totally sealed
- Required opening dim: (tile to tile) 750 width
- Glass door dims: W 745 (inc. hinge) x H 1900



PENTA 1 - FLAT ROOF OPTION

DESCRIPTION	SIZE (mm)	PRODUCT CODE	PRICE
PENTA 1 FLAT ROOF OPTION	N/A	EMSC-05-1005	£238.00

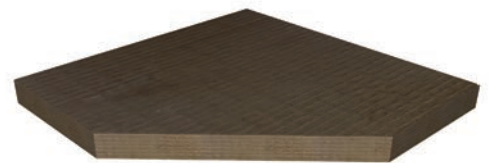

PENTA 1 - DOOR HEADER OPTION (FOR USE WITH STEAM DOORS)

DESCRIPTION	SIZE (mm)	PRODUCT CODE	PRICE
PENTA DOOR HEADER OPTION	600	EMSC-05-1010	£95.00

Note: door header can be cut to size on site



Penta 2 Shower Cubicle

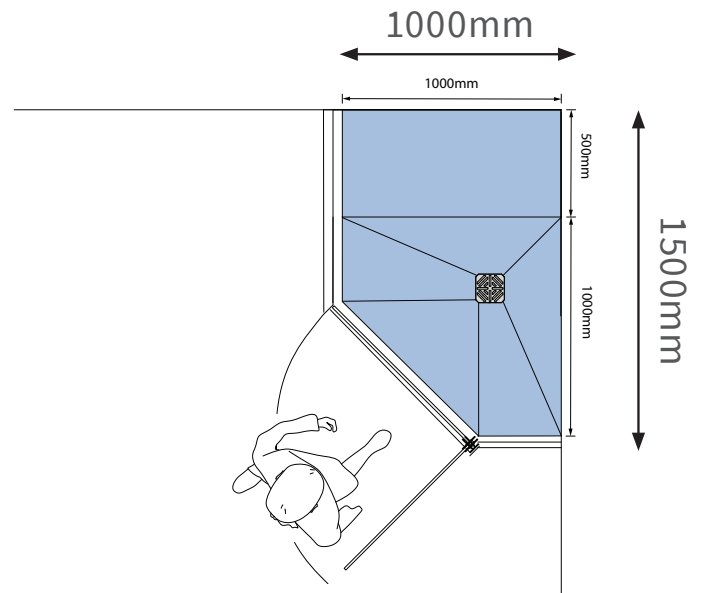

SUPPLIED WITH



Full Installation &
Drainage Kit

PENTA 2 CUBICLE - UNIVERSAL FOR LEFT & RIGHT HAND INSTALLATIONS

DESCRIPTION	SIZE (mm)	PRODUCT CODE	PRICE
PENTA 2 CUBICLE INC. FULL INSTALLATION & DRAINAGE KIT	2460 x 1500 x 1000	EMSC-10-0505	£1,990.00



PENTA 2 CUBICLE - FRAMELESS GLASS DOOR

DESCRIPTION	SIZE (mm)	PRODUCT CODE	PRICE
PENTA CUBICLE FRAMELESS GLASS DOOR	1900 x 745 x 8	VEGX-15-1305	£399.00

- Frameless glass shower door 8mm supplied with 2 chrome hinges
- Door suits L & R opening
- Note: These shower doors are not designed to be totally sealed
- Required opening dim: (tile to tile) 750 width
- Glass door dims: W 745 (inc. hinge) x H 1900



PENTA 2 SUBSTRATE ELEMENT - FOR LEFT OR RIGHT HAND

DESCRIPTION	SIZE (mm)	PRODUCT CODE	PRICE
PENTA 2 SUBSTRATE ELEMENT - FOR L/H OR R/H	1500 x 1000 x 80	EMSC-10-1010	£114.00

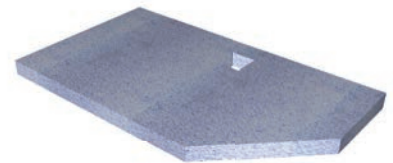

PENTA 2 CUBICLE - SEAT OPTION

DESCRIPTION	SIZE (mm)	PRODUCT CODE	PRICE
PENTA 2 CUBICLE - SEAT OPTION	920 x 525 x 520	EMSC-10-1015	£394.00

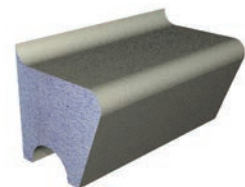

PENTA 2 - FLAT ROOF OPTION

DESCRIPTION	SIZE (mm)	PRODUCT CODE	PRICE
PENTA 2 FLAT ROOF OPTION	1500 x 1000 x 80	EMSC-10-1005	£349.00

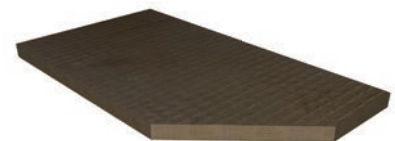

PENTA 2 - DOOR HEADER OPTION (FOR USE WITH STEAM DOORS)

DESCRIPTION	SIZE (mm)	PRODUCT CODE	PRICE
PENTA DOOR HEADER OPTION	600	EMSC-05-1010	£95.00



Note: door header can be cut to size on site

Curva 1 Shower Cubicle



CURVA 1 CUBICLE - LEFT & RIGHT HANDED

DESCRIPTION	SIZE (mm)	PRODUCT CODE	PRICE
CURVA 1 CUBICLE - LEFT HAND INC. FULL INSTALLATION & DRAINAGE KIT	2460 x 1450 x 1000	EMSC-15-0505	£1,795.00
CURVA 1 CUBICLE - RIGHT HAND INC. FULL INSTALLATION & DRAINAGE KIT	2460 x 1450 x 1000	EMSC-15-0510	£1,795.00

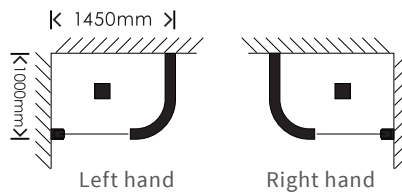

CURVA 1 CUBICLE - FRAMELESS GLASS DOOR

DESCRIPTION	SIZE (mm)	PRODUCT CODE	PRICE
CURVA 1 CUBICLE FRAMELESS GLASS DOOR	1900 x 672 x 8	VEGX-15-1310	£399.00

- Frameless glass shower door 8mm supplied with 2 chrome hinges
- Door suits L & R opening
- Note: These shower doors are not designed to be totally sealed
- Required opening dim: (tile to tile) 677 width
- Glass door dims: W 672 (inc. hinge) x H 1900



CURVA 1 SUBSTRATE ELEMENT - FOR LEFT & RIGHT HAND

DESCRIPTION	SIZE (mm)	PRODUCT CODE	PRICE
CURVA 1 SUBSTRATE ELEMENT - FOR L/H OR R/H	1450 x 1000 x 80	EMSC-15-1005	£114.00

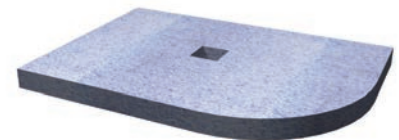

CURVA 1 CUBICLE - DECOR TRIM SET OPTION

DESCRIPTION	SIZE (mm)	PRODUCT CODE	PRICE
CURVA 1 CUBICLE DECOR TRIM SET INC. 2X CURVED TRIM + 1X CURVED BASE PLATFORM	N/A	EMSC-15-1010	£294.00

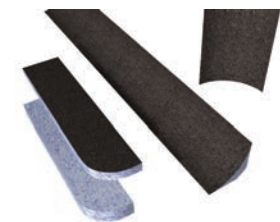

CURVA 1 CUBICLE - FLAT ROOF OPTION

DESCRIPTION	SIZE (mm)	PRODUCT CODE	PRICE
CURVA 1 CUBICLE - FLAT ROOF OPTION FOR L/H OR R/H	1450 x 1000 x 80	EMSC-15-1015	£349.00

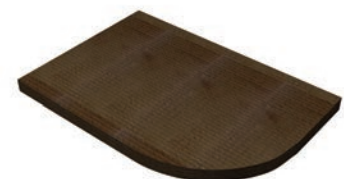

CURVA 1 - DOOR HEADER OPTION (FOR USE WITH STEAM DOORS)

DESCRIPTION	SIZE (mm)	PRODUCT CODE	PRICE
CURVA 1 DOOR HEADER OPTION	600	EMSC-15-1020	£95.00

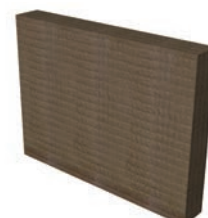

Note: door header can be cut to size on site

Quarto Shower Cubicle



QUARTO CUBICLE - RECESSED & CORNER VERSIONS

DESCRIPTION	SIZE (mm)	PRODUCT CODE	PRICE
QUARTO CUBICLE - RECESSED FOR L/H OR R/H INSTALLATION INC. FULL INSTALLATION & DRAINAGE KIT	2460 x 1850 x 900	EMSC-20-0505	£1,895.00
QUARTO CUBICLE - CORNER FOR L/H OR R/H INSTALLATION INC. FULL INSTALLATION & DRAINAGE KIT	2460 x 1850 x 900	EMSC-20-0510	£1,995.00



Full Installation & Drainage Kit



Recessed Version

QUARTO CUBICLE - FRAMELESS GLASS DOOR

DESCRIPTION	SIZE (mm)	PRODUCT CODE	PRICE
QUARTO CUBICLE FRAMELESS GLASS DOOR	1900 x 672 x 8	VEGX-15-1310	£399.00

- Frameless glass shower door 8mm supplied with 2 chrome hinges
- Door suits L & R opening
- Note: These shower doors are not designed to be totally sealed
- Required opening dim: (tile to tile) 677 width
- Glass door dims: W 672 (inc. hinge) x H 1900



QUARTO SUBSTRATE ELEMENT - FOR LEFT & RIGHT HAND

DESCRIPTION	SIZE (mm)	PRODUCT CODE	PRICE
QUARTO SUBSTRATE ELEMENT - FOR L/H OR R/H SUPPLIED IN 2 PARTS	1850 x 900 x 80	EMSC-20-1005	£138.00

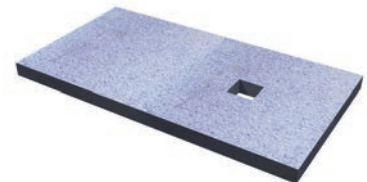

QUARTO CUBICLE - SEAT OPTION

DESCRIPTION	SIZE (mm)	PRODUCT CODE	PRICE
QUARTO CUBICLE - SEAT OPTION	820 x 525 x 520	EMSC-20-1015	£394.00

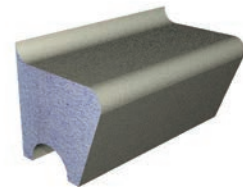

QUARTO CUBICLE - FLAT ROOF OPTION

DESCRIPTION	SIZE (mm)	PRODUCT CODE	PRICE
QUARTO CUBICLE - FLAT ROOF OPTION	1850 x 900 x 80	EMSC-20-1010	£349.00



QUARTO - DOOR HEADER OPTION (FOR USE WITH STEAM DOORS)

DESCRIPTION	SIZE (mm)	PRODUCT CODE	PRICE
QUARTO DOOR HEADER OPTION	600	EMSC-15-1020	£95.00



Note: door header can be cut to size on site

Snail Shower Cubicle



SNAIL SHOWER - LEFT & RIGHT HANDED

DESCRIPTION	SIZE (mm)	PRODUCT CODE	PRICE
SNAIL CUBICLE - LEFT HAND INC. FULL INSTALLATION & DRAINAGE KIT	2460 x 1950 x 1440	EMSC-25-0505	£3,354.00
SNAIL CUBICLE - RIGHT HAND INC. FULL INSTALLATION & DRAINAGE KIT	2460 x 1950 x 1440	EMSC-25-0510	£3,354.00



Full Installation
& Drainage Kit

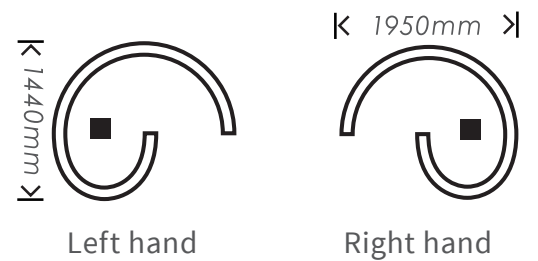
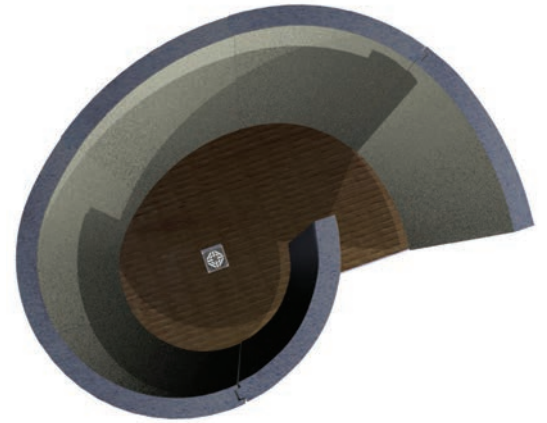

SNAIL SHOWER SUBSTRATE ELEMENT - FOR LEFT & RIGHT HAND

DESCRIPTION	SIZE (mm)	PRODUCT CODE	PRICE
SNAIL SHOWER SUBSTRATE ELEMENT - L/H & R/H	1950 x 1440 x 80	EMSC-25-1005	£139.00

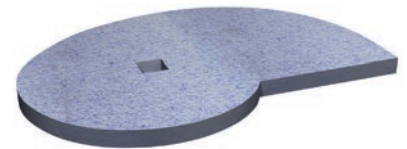

SNAIL SHOWER - FLAT ROOF OPTION

DESCRIPTION	SIZE (mm)	PRODUCT CODE	PRICE
SNAIL SHOWER - FLAT ROOF OPTION - L/H & R/H	1950 x 1440 x 40	EMSC-25-1015	£479.00

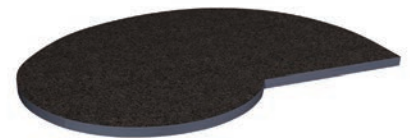

SNAIL SHOWER - ROUND TO FLAT SECTION FOR VALVE INSTALLATION

DESCRIPTION	SIZE (mm)	PRODUCT CODE	PRICE
SNAIL SHOWER - ROUND TO FLAT SECTION FOR VALVE INSTALLATION	2420 x 350 x 35 Supplied in 1.2m lengths	EMSC-25-1020	£199.00





Circo Shower Cubicle

CIRCO SHOWER - 2460mm x 1250 DIA.

DESCRIPTION	SIZE (mm)	PRODUCT CODE	PRICE
CIRCO SHOWER - 1250 DIA. x 2460 INC. FULL INSTALLATION & DRAINAGE KIT	2460 x 1250 dia.	EMSC-30-0505	£2,150.00



Full Installation
& Drainage Kit

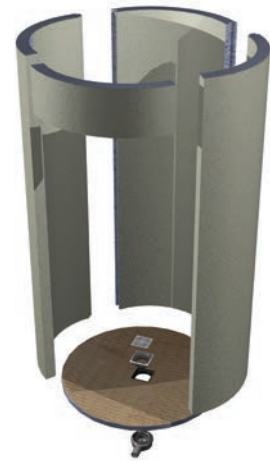

CIRCO CURVED - FRAMELESS GLASS DOOR

DESCRIPTION	SIZE (mm)	PRODUCT CODE	PRICE
CIRCO CURVED FRAMELESS GLASS DOOR	1900 x 617	VEGX-17-1305	£695.00

- Frameless glass shower door 8mm supplied with 2 chrome hinges
 - Door suits L & R opening
- Note: These shower doors are not designed to be totally sealed



CIRCO SHOWER - SUBSTRATE ELEMENT

DESCRIPTION	SIZE (mm)	PRODUCT CODE	PRICE
CIRCO SHOWER SUBSTRATE ELEMENT	1250 dia. x 80	EMSC-30-1005	£79.00

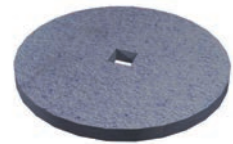

CIRCO SHOWER - DECOR TRIM SET

DESCRIPTION	SIZE (mm)	PRODUCT CODE	PRICE
CIRCO SHOWER - DECOR TRIM SET 2x FINISHING COLUMN 80mm NOTE: CANNOT BE USED WITH GLASS DOOR OPTION	2420 x 125 dia.	EMSC-30-1010	£199.00



CIRCO SHOWER - FLAT ROOF OPTION

DESCRIPTION	SIZE (mm)	PRODUCT CODE	PRICE
CIRCO SHOWER - FLAT ROOF OPTION	1250 dia. x 80	EMSC-30-1015	£300.00



CIRCO SHOWER - ROUND TO FLAT SECTION FOR VALVE INSTALLATION

DESCRIPTION	SIZE (mm)	PRODUCT CODE	PRICE
CIRCO SHOWER - ROUND TO FLAT SECTION FOR VALVE INSTALLATION	2420 x 350 x 35 Supplied in 1.2m lengths	EMSC-30-1020	£199.00





BESPOKE PRODUCTS

If you do not find your required product in this brochure do not worry! We have the ability to produce products specifically to our customers' own requirements.

With a dedicated in-house CAD design team, we have the ability to design bespoke applications for both domestic and commercial situations.

Whether your requirements are wetrooms, baths, vanity units, decorative elements or shower cubicles, please feel free to contact our sales department with your exact requirements.

sales office: 0345 850 50 40

Bespoke & Wellness Products



ELEMENTS BESPOKE

The only limit is your imagination.

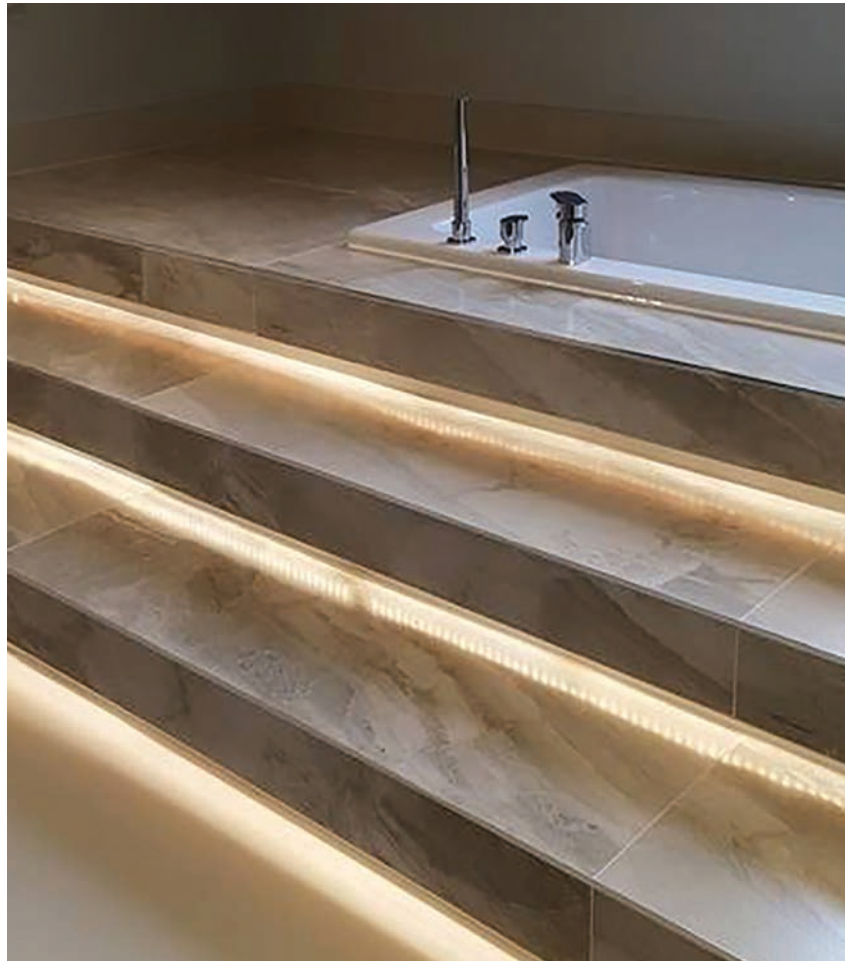



WETROOM GLASS PANELS

The ultimate in wetroom luxury. X Series offers a range of twelve sizes of 10mm toughened glass panels all with Easi-Clean coating.

Together with a comprehensive range of support bars and channels, X Series lets you be totally creative in your wetroom design whilst offering outstanding value.

Easi-Clean:

- Keeps glass looking like new
- Reduces water spots (limescale and mineral deposits)
- Is always easier to clean
- Stays cleaner for longer
- Significantly reduces the growth of bacteria



Wetroom Glass

X SERIES



How to order X Series Wetroom Glass in 5 easy steps

THE POSSIBILITIES ARE TRULY LIMITLESS WITH THE NEW X SERIES RANGE OF GLASS, CHANNELS, CLAMPS AND SUPPORT BARS.

1. Create your design

By combining one or more pieces of X Series glass together with our range of vertical channels, you have the ability to create anything from a simple piece of glass to complex screens with return panels.



2. Choose your glass size

The X Series of 10mm toughened glass covers a variety of sizes from 290mm right up to 1190mm in width and 2000mm height so you can be sure to find a size to suit.

X Series glass is supplied with Easi-Clean technology at no extra charge which helps reduce limescale deposit build-up and keeps your glass cleaner for longer.



3. Choose your preferred glass channel

Your X Series glass should be supported within a floor and wall channel. The X Series offers three options to suit your design requirements:

- Our X Series Surface Channel has a clever two layered base so that the glass is raised higher than the screw head. This channel is best suited for applications where the tile has already been laid.
- Alternatively our X Series Recessed Floor & Wall Channel can be installed when tiling to give a minimalistic look.
- Our innovative new V Fix channel allows you to use channelling without the need for silicone which is a great time-saving option.



4. Choose your wall/ceiling support

Depending on the size of the glass you are installing we would recommend that you give the glass panel additional support with an X Series Support Bar. These are available in both horizontal and vertical options and can be cut down to suit your application. See opposite for a guide to choosing glass supports.



5. Finish the look

The X Series includes a range of complementary accessories to give that final touch to your design. Why not add a Double Robe Hook or Towel Hanging Bar with Glass Shelf?

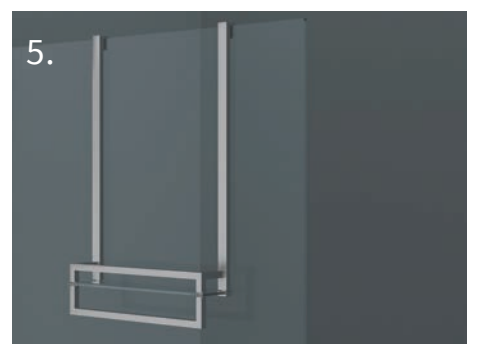

A Guide to Choosing Glass Support

1.

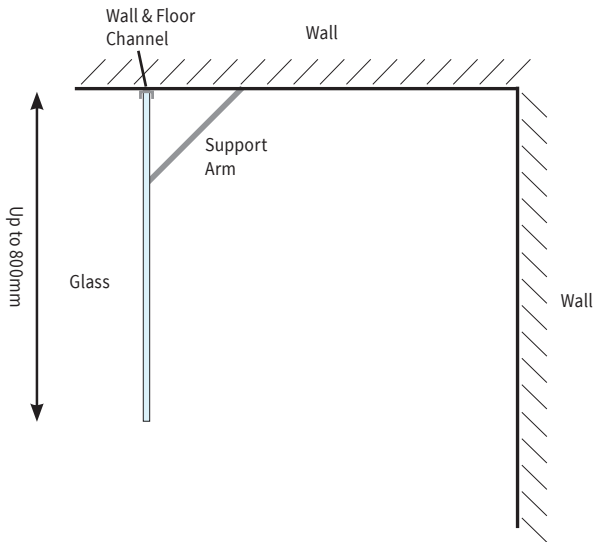

2.

General option for glass over 800mm

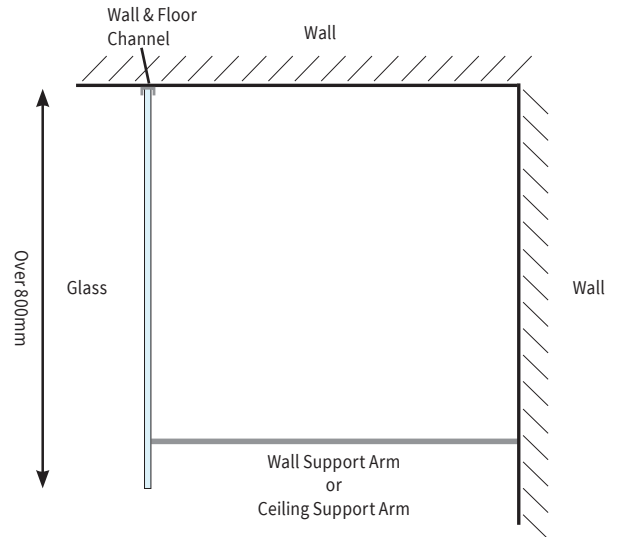

3.

General option for glass over 800mm

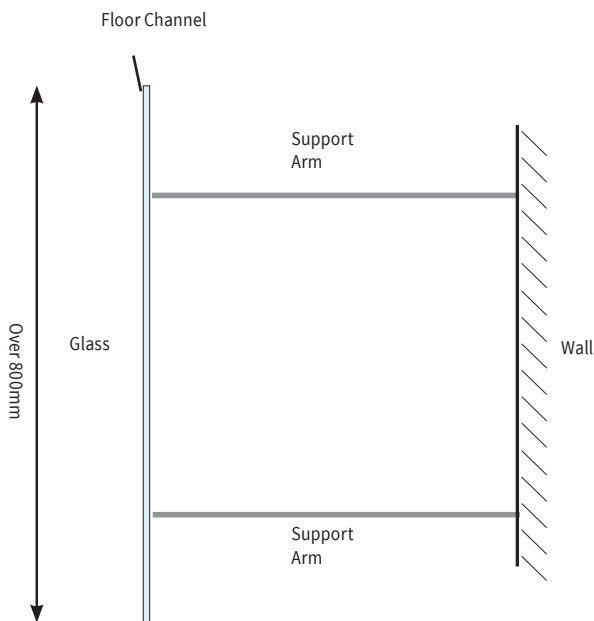

4.

General option for glass over 800mm

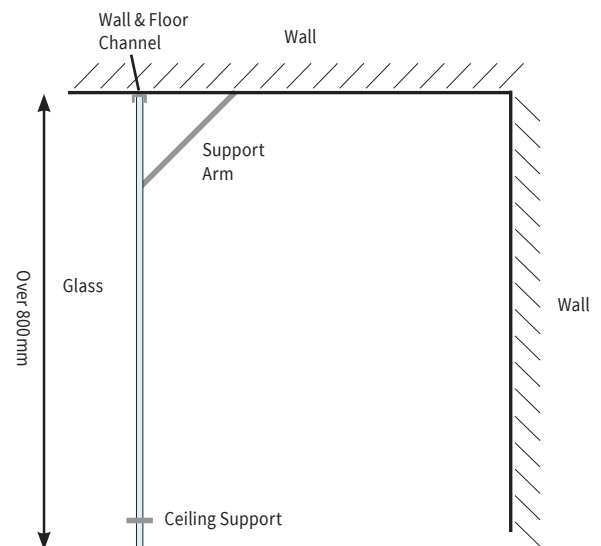

Note: These general options are suggestions only, there is no right or wrong way to support bespoke glass panels. Abacus Direct cannot be held responsible for the suggestions shown above as the designers and installers need to be comfortable with the correct level of support required for each project.



X Series Glass Panels

290mm - 1190mm WIDTH
10mm TOUGHENED SAFETY GLASS - 2.0m HIGH

The X Series begins with a range of 12 glass panels which can be used collectively or independently to create any shower combination you wish for. Specifically designed for use in wet rooms the X Series brings a timeless elegance to any shower setting.

X Series Bespoke Option

If you require a glass option outside our standard sizes please ring our sales office who will be pleased to quote you on any bespoke size. Options can include glass in different shapes and thicknesses and etched designs to your specification.



X SERIES GLASS PANELS – 290mm - 735mm WIDE

DESCRIPTION	WIDTH (mm)	HEIGHT (mm)	ADJUSTMENT (mm)	THICKNESS (mm)	PRODUCT CODE	PRICE
GLASS PANEL - 290mm WIDE	290	2000	Dependent on channel	10	VEGX-00-1005	£118.00
GLASS PANEL - 390mm WIDE	390	2000	Dependent on channel	10	VEGX-00-1010	£149.00
GLASS PANEL - 490mm WIDE	490	2000	Dependent on channel	10	VEGX-00-1015	£179.00
GLASS PANEL - 590mm WIDE	590	2000	Dependent on channel	10	VEGX-00-1020	£214.00
GLASS PANEL - 690mm WIDE	690	2000	Dependent on channel	10	VEGX-00-1025	£252.00
GLASS PANEL - 735mm WIDE	735	2000	Dependent on channel	10	VEGX-00-1030	£258.00

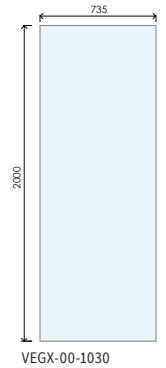
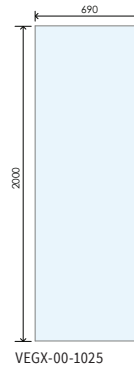
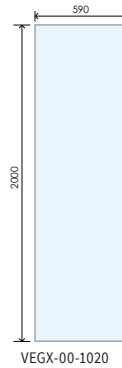
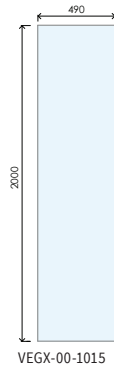
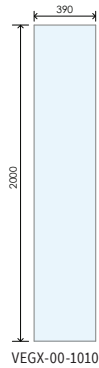
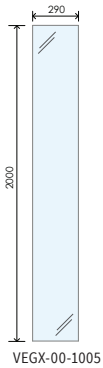

X SERIES GLASS PANELS – 790mm - 1190mm WIDE

DESCRIPTION	WIDTH (mm)	HEIGHT (mm)	ADJUSTMENT (mm)	THICKNESS (mm)	PRODUCT CODE	PRICE
GLASS PANEL - 790mm WIDE	790	2000	Dependent on channel	10	VEGX-00-1035	£282.00
GLASS PANEL - 835mm WIDE	835	2000	Dependent on channel	10	VEGX-00-1040	£294.00
GLASS PANEL - 890mm WIDE	890	2000	Dependent on channel	10	VEGX-00-1045	£348.00
GLASS PANEL - 990mm WIDE	990	2000	Dependent on channel	10	VEGX-00-1050	£372.00
GLASS PANEL - 1090mm WIDE	1090	2000	Dependent on channel	10	VEGX-00-1055	£450.00
GLASS PANEL - 1190mm WIDE	1190	2000	Dependent on channel	10	VEGX-00-1060	£477.00

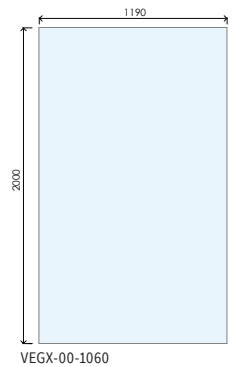
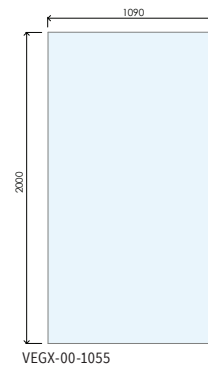
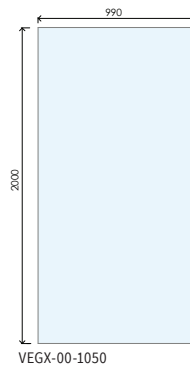
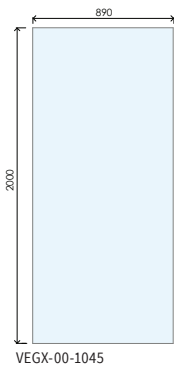
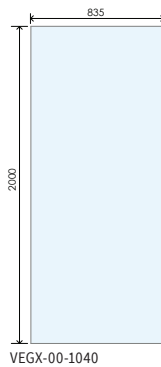
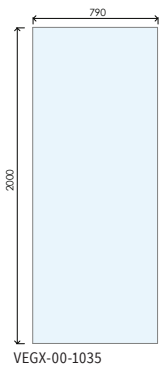



X Series Glass Channels & Clamps

SURFACE CHANNEL WITH CONCEALED SCREWS

X Series Surface Channel for 10mm Glass

FINISH	LENGTH (mm)	PRODUCT CODE	PRICE
POLISHED	1000	VEGX-80-0105	£14.40
POLISHED	2000	VEGX-80-0110	£28.80
BRUSHED NICKEL	1000	VEGX-80-0705	£21.60
BRUSHED NICKEL	2000	VEGX-80-0710	£35.40

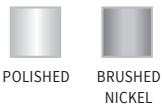
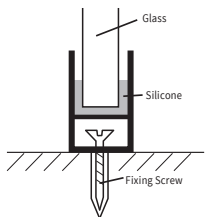

- Special two layered base for concealing screw heads
- Supplied with end caps

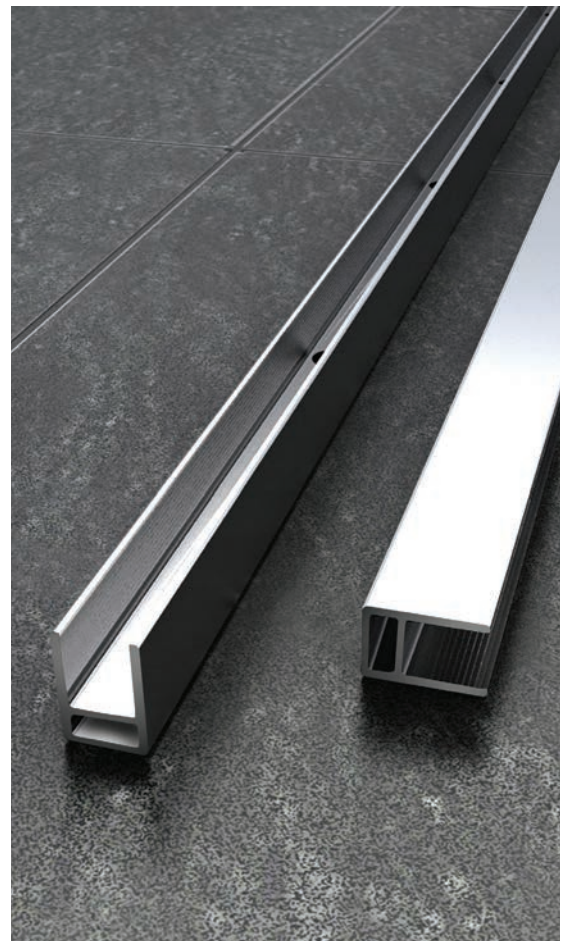
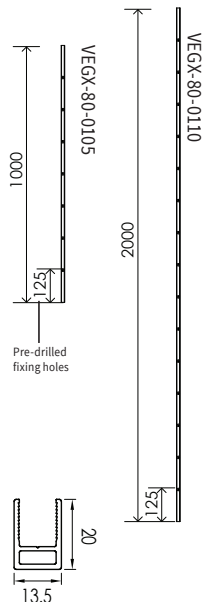

RECESSED CHANNEL

X Series Recessed Channel for 10mm Glass

FINISH	LENGTH (mm)	PRODUCT CODE	PRICE
POLISHED	1000	VEGX-80-0115	£14.40
POLISHED	2000	VEGX-80-0120	£28.80

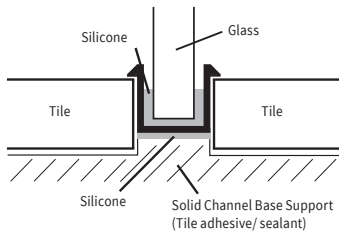

Channels used on the floor require base support to support glass weight

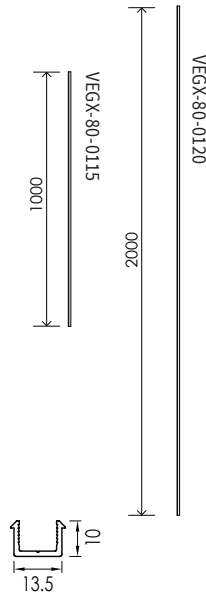

V-FIX CHANNEL - SILICONE-FREE

V-Fix Silicone-free Channel for 10mm Glass

FINISH	LENGTH (mm)	PRODUCT CODE	PRICE
POLISHED	1200	VEGC-80-0135	£30.60
POLISHED	2200	VEGC-80-0140	£47.40
BRUSHED NICKEL	1200	VEGC-80-0735	£34.80
BRUSHED NICKEL	2200	VEGC-80-0740	£52.20

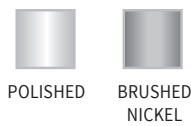
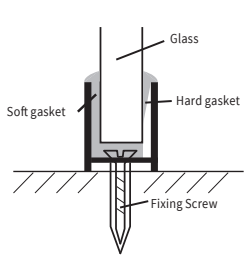

Can be adhered to floor tiled surfaces using Abacus Elements Fix-MD Adhesive

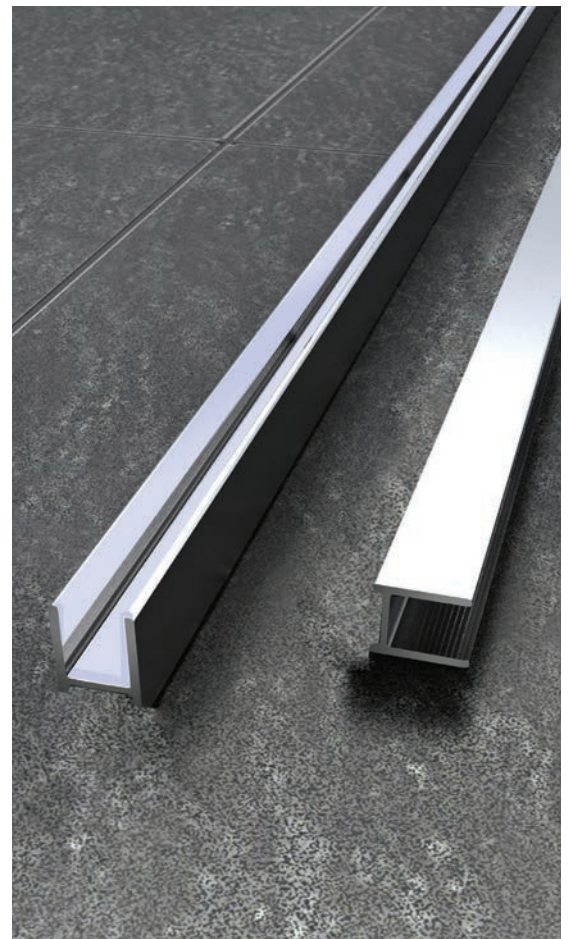
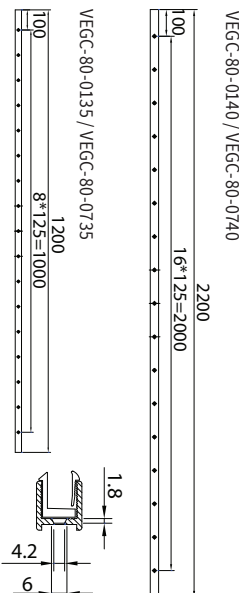

X Series Designer Wall & Ceiling Bars

X SERIES DESIGNER WALL SUPPORT ARM GLASS-WALL

LENGTH (mm)	PRODUCT CODE	PRICE
1000	VEGX-85-0320	£129.00
1200	VEGX-85-0325	£139.00



POLISHED

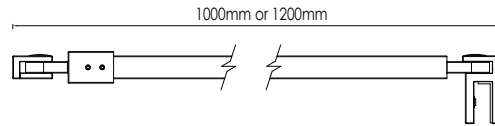

The support arms can be cut down to required length.



X SERIES DESIGNER CORNER SUPPORT ARM GLASS-GLASS & GLASS-WALL

LENGTH (mm)	PRODUCT CODE	PRICE
300	VEGX-85-0305	£78.00



POLISHED

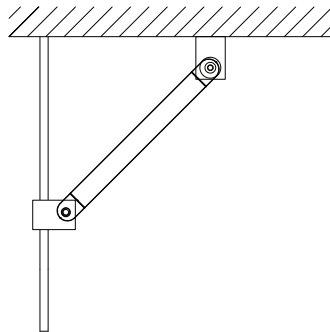

Supplied complete with fitting to support glass to glass and glass to wall.



X SERIES DESIGNER CEILING SUPPORT ARM GLASS-CEILING

HEIGHT (mm)	PRODUCT CODE	PRICE
400	VEGX-85-0310	£85.00
1000	VEGX-85-0315	£129.00



POLISHED



The support arms can be cut down to required length. To be used in conjunction with wall support.



X SERIES DOUBLE ROBE HOOK

LENGTH (mm)	PRODUCT CODE	PRICE
N/A	VEGX-90-0305	£25.80 (EACH)



POLISHED

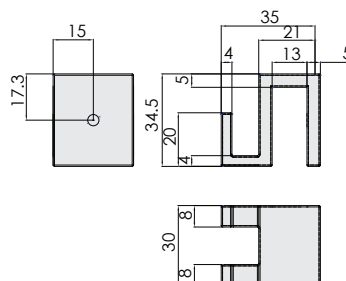

Clamps easily on to the top of all X Series glass panels.



X Series Support Bars & Accessories

X SERIES DESIGNER TOWEL HANGING BAR WITH GLASS SHELF

WIDTH (mm)	HEIGHT (mm)	PRODUCT CODE	PRICE
430	685	VEGX-90-0310	£119.50



POLISHED

Hangs easily on to the top of all X Series glass panels.

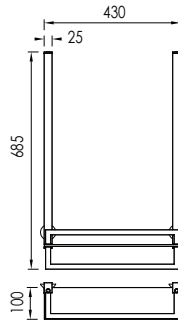

STANDARD WALL SUPPORT ARM GLASS-WALL (TELESCOPIC)

LENGTH MAX-MIN (mm)	PRODUCT CODE	PRICE
780 - 1020	VEGC-05-0505	£58.80



BRUSHED

Minimum Adjustment - 780mm
Maximum Adjustment - 1020mm
For use on 8 - 12mm glass

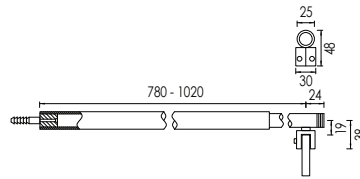

STANDARD SUPPORT ARM GLASS-GLASS

LENGTH MAX-MIN (mm)	PRODUCT CODE	PRICE
980 - 1220	VEGC-05-0507	£58.80



BRUSHED

Minimum Adjustment - 980mm
Maximum Adjustment - 1220mm
For use on 8 - 12mm glass

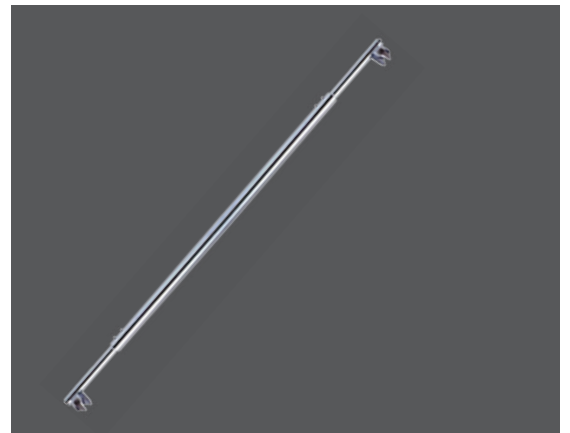
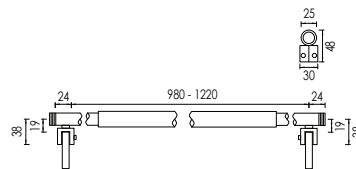



X Series Glass Channels & Clamps

MAKE YOUR OWN DESIGN OF GLASS WITH OUR VERSATILE RANGE OF CHANNELS AND CLAMPS



X SERIES STRAIGHT CONNECTING CHANNEL 2000mm

HEIGHT (mm)	PRODUCT CODE	PRICE
2000	VEGX-80-0140	£38.40



POLISHED

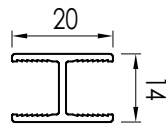

X SERIES 135 DEGREE CORNER CHANNEL 2000mm

HEIGHT (mm)	PRODUCT CODE	PRICE
2000	VEGX-80-0130	£38.40



POLISHED

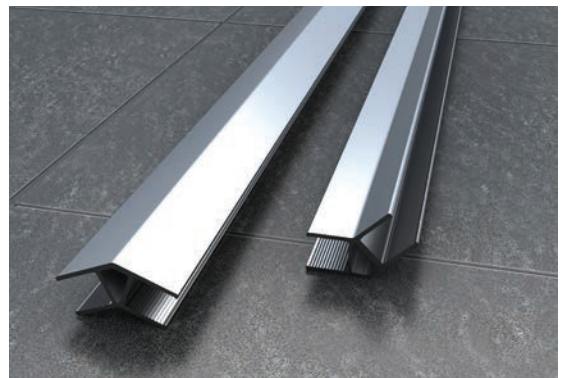
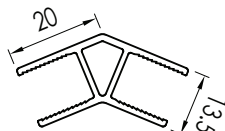

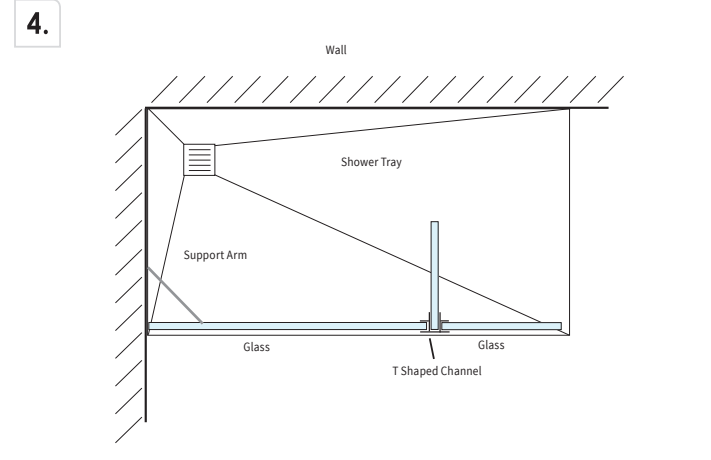
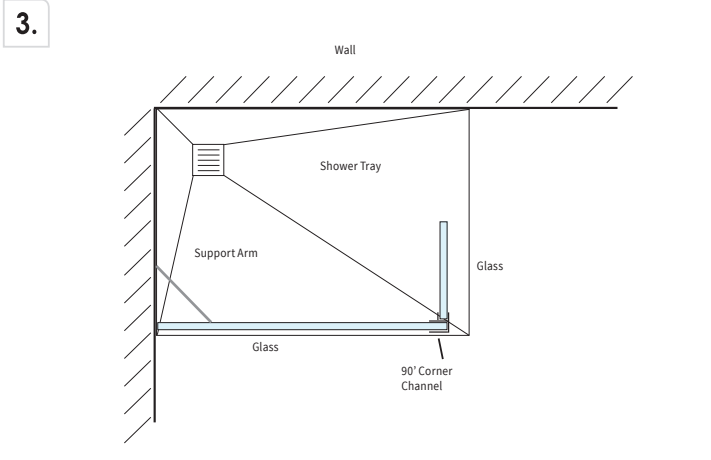
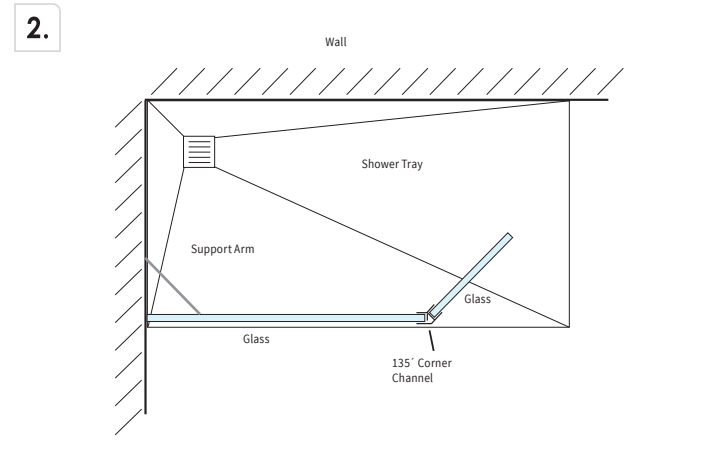
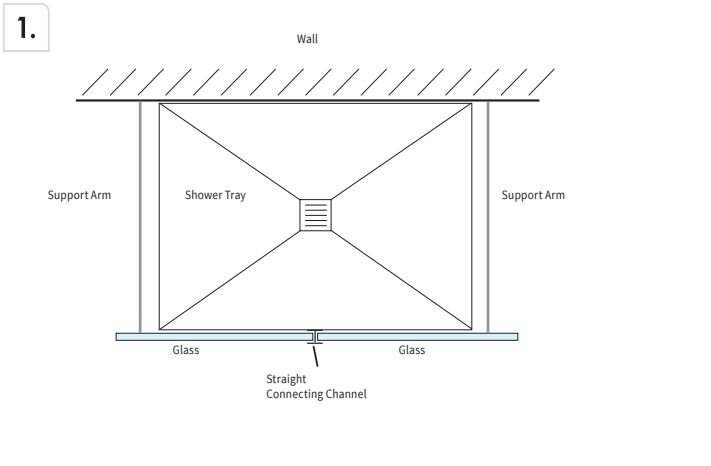

X SERIES 90 DEGREE CORNER CHANNEL 2000mm

HEIGHT (mm)	PRODUCT CODE	PRICE
2000	VEGX-80-0125	£38.40



POLISHED

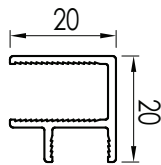

X SERIES T SHAPED CHANNEL 2000mm

HEIGHT (mm)	PRODUCT CODE	PRICE
2000	VEGX-80-0135	£42.00



POLISHED

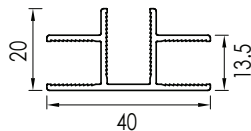



E SERIES WALK-IN GLASS SCREENS

The E Series offers the ultimate in affordable luxury. Incorporating a range of walk-in shower screens and end panels, bath screens and sliding shower screens.

The E Series comes with Easi-Clean Glass Coating Technology as standard.

Easi-Clean:

- Keeps glass looking like new
- Reduces water spots (limescale and mineral deposits)
- Is always easier to clean
- Stays cleaner for longer
- Significantly reduces the growth of bacteria



Walk-in Glass Screens

E SERIES



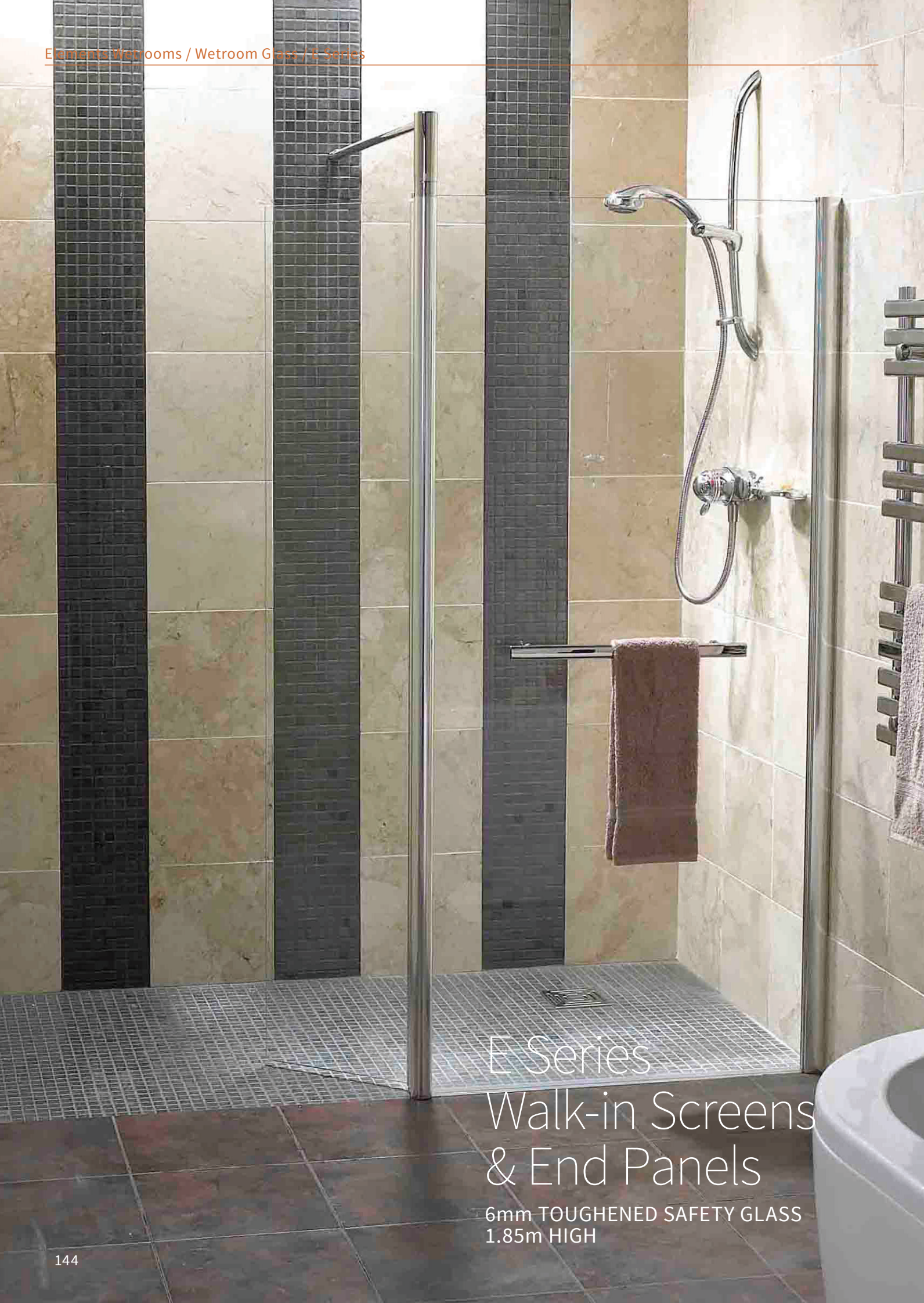

E-Series
Walk-in Screens
& End Panels

6mm TOUGHENED SAFETY GLASS
1.85m HIGH

WALK-IN SHOWER SCREEN WITH 180° RETURN PANEL

DESCRIPTION	WIDTH (mm)	HEIGHT (mm)	ADJUSTMENT (mm)	THICKNESS (mm)	PRODUCT CODE	PRICE
WALK-IN SCREEN 700 + 350mm	700 + 350	1850	15	6	VEGE-10-1105	£546.00
WALK-IN SCREEN 900 + 350mm	900 + 350	1850	15	6	VEGE-10-1110	£582.00

 **Easi-Clean**
glass coating technology

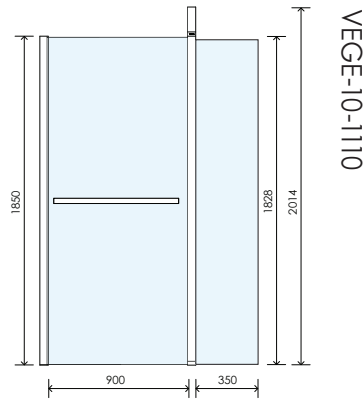
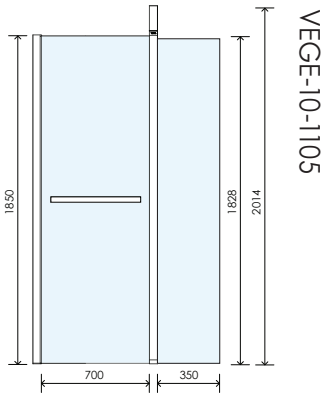

WALK-IN SHOWER SCREEN END PANEL

DESCRIPTION	WIDTH (mm)	HEIGHT (mm)	ADJUSTMENT (mm)	THICKNESS (mm)	PRODUCT CODE	PRICE
WALK-IN SCREEN END PANEL	700	1850	15	6	VEGE-05-1105	£450.00
WALK-IN SCREEN END PANEL	850	1850	15	6	VEGE-05-1110	£474.00

 **Easi-Clean**
glass coating technology

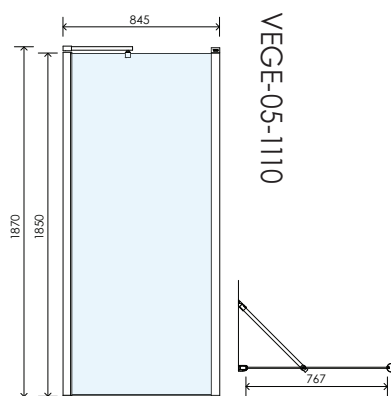
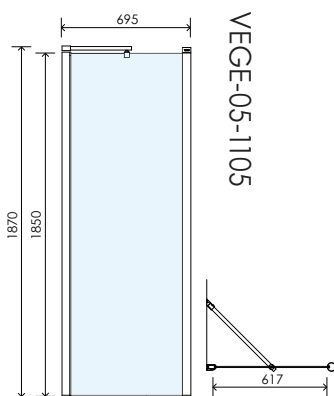

Curved Glass Walk-in Screen

E SERIES CURVED GLASS SCREEN 8mm TOUGHENED SAFETY GLASS - 2.0m HIGH

DESCRIPTION	WIDTH (mm)	HEIGHT (mm)	ADJUSTMENT (mm)	THICKNESS (mm)	PRODUCT CODE	PRICE
CURVED GLASS SCREEN - 1050mm WIDE	1050	2000	5	8	VEGE-12-1105	£630.00

Note: Glass Floor Fixing Clip included.

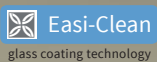
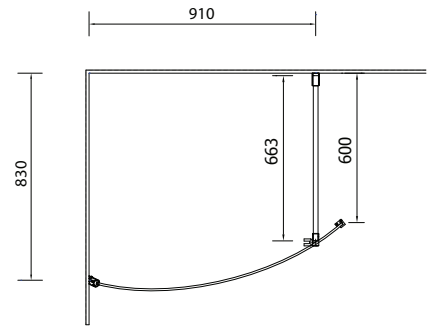
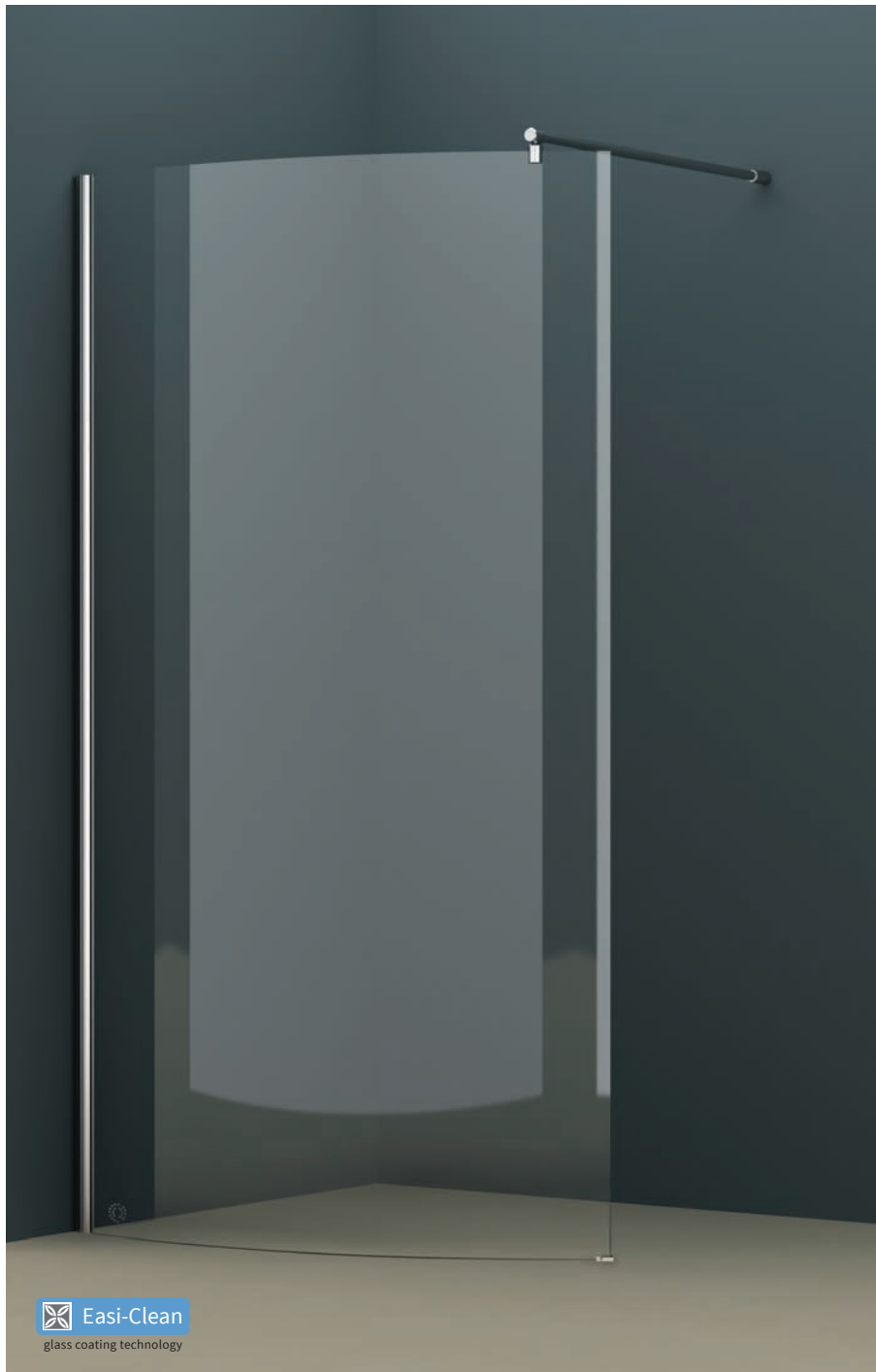
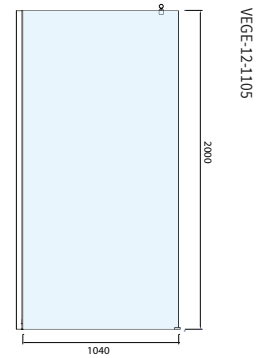

Curved Glass Screen



M SERIES DESIGNER WETROOM SHOWER SCREENS.

Elegant Simplicity

The M series 8mm wetroom screens incorporate a 350mm return splash panel and are available in two sizes to suit almost any size of wetroom, however small.

They feature elegant glass-to-glass hinges and a designer towel bar as standard.

There are also two matching end panels for these screens and all products come as standard with Easi-Clean technology.



Wetroom Glass

M SERIES





M Series Walk-in Screens & End Panels

8mm TOUGHENED SAFETY GLASS
2.0m HIGH

WALK-IN SHOWER SCREEN WITH 180° RETURN PANEL

DESCRIPTION	WIDTH (mm)	HEIGHT (mm)	ADJUSTMENT (mm)	THICKNESS (mm)	PRODUCT CODE	PRICE
WALK-IN SCREEN 700 + 350mm	700 + 350	2000	15	8	VEGM-10-1105	£718.00
WALK-IN SCREEN 900 + 350mm	900 + 350	2000	15	8	VEGM-10-1110	£750.00

 **Easi-Clean**
glass coating technology

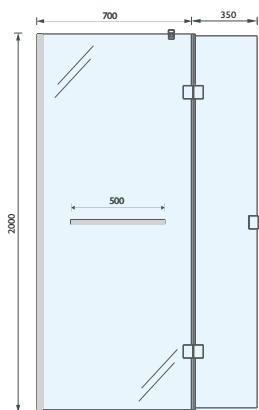

VEGM-10-1110

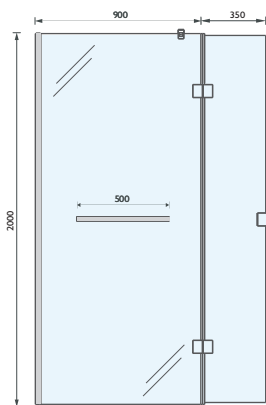

VEGM-10-1105



WALK-IN SHOWER SCREEN END PANEL

DESCRIPTION	WIDTH (mm)	HEIGHT (mm)	ADJUSTMENT (mm)	THICKNESS (mm)	PRODUCT CODE	PRICE
WALK-IN SCREEN END PANEL	700	2000	15	8	VEGM-05-1105	£372.00
WALK-IN SCREEN END PANEL	850	2000	15	8	VEGM-05-1110	£390.00

 **Easi-Clean**
glass coating technology

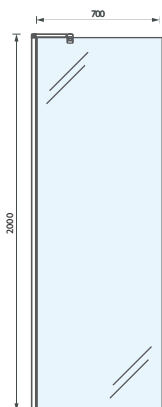

VEGM-05-1105

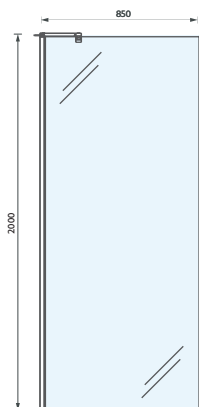

VEGM-05-1110



Bespoke Doors & Panels

CREATE YOUR OWN GLASS DESIGNS AND TURN YOUR DREAMS INTO A REALITY

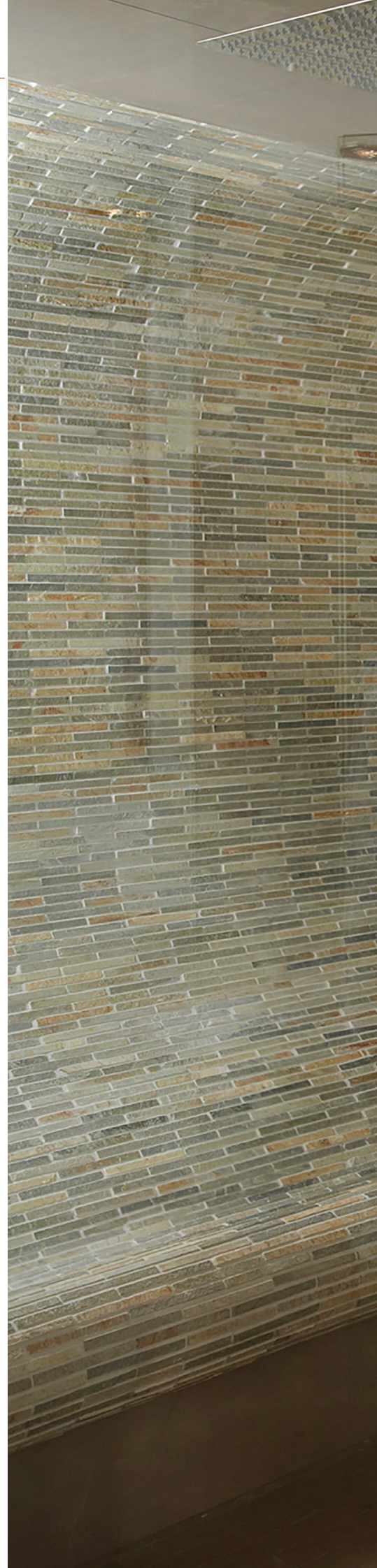



Bespoke Doors & Panels

CREATE YOUR OWN DESIGN AND TURN YOUR DREAMS INTO A REALITY

As wet rooms and walk-in shower rooms become ever more popular, so does the production of bespoke glass screens. Curved or flat, clear or tinted, send us your ideas and get a quote for your unique design which will be produced for you to the highest quality.



Bespoke Doors & Panels

All glass is made out of safety toughened glass. Standard components can be ordered in a number of different finishes.

With our range of hinges, handles and accessories and our ability to manufacture glass in almost any size and thickness you can create your own bespoke piece to meet your requirements.

Please contact your Abacus Bathrooms dealer or email us at enquiries@abacus-bathrooms.co.uk



General

Prices

The prices displayed throughout this catalogue supersede all other previous publicised price lists. All prices include VAT and are subject to change without prior notice.

Returns

Goods may be returned for credit only following written approval by Abacus.

Special-order or bespoke items are non-returnable.

Order cancellation will be subject to a 25% re-stocking charge.

Abacus reserve the right to refuse credit on goods returned damaged or in a condition unfit for resale.

Also there may be an applicable charge for the re-boxing of a returned product.

Delivery

All orders below a nett invoice value of £100 (ex. VAT) will incur a £6.95 delivery charge.

The Company must be notified within 14 days of any claim for a product not delivered.

Abacus will do our best to deliver all orders on time and complete, however we cannot accept any liability for delays or failure to deliver products.

Care and maintenance

Abacus products are manufactured to exacting standards and following the care and cleaning guidelines below will ensure that your bathroom will give you years of effective use.

Brass Products

Brass products should be cleaned with a diluted mild detergent such as washing up liquid applied with a soft sponge or cloth, and then buffed dry with a microfibre cloth.

Avoid using acids, rough sponges or steel wool and do not leave detergent on the products for long periods of time.

Glass

Our glass wetroom screens are protected by an easy-clean nano-technology coating to make cleaning easier. We recommend that glass screens are cleaned with a diluted detergent and dried with a microfibre cloth. We recommend regular wiping of glass screens in order to remove excess water, which in some areas can be quite aggressive.

GENERAL

NEVER use products containing bleach on bathroom products or any cleaners or cloths of an abrasive nature.

Product Guarantee*

Unless stated below all Elements products carry a 15 year guarantee.

- The guarantee covers products which have been installed to the manufacturer's instructions, and if used in a bathroom, the room is deemed to have suitable ventilation in accordance with UK building regulations.
- The guarantee is available to original purchasers who have proof of purchase and is non-transferable.
- Abacus operate a policy of continued product development. In the event that a faulty product has been superseded, Abacus will replace the product with the nearest equivalent item. Abacus reserve the right to change designs and specifications without prior notice.
- In the event of a product fault after installation, Abacus must be given the opportunity to inspect the item in its installed state.
- The guarantee does not cover consequential loss. (Your statutory rights are not affected).
- The guarantee does not cover products that have been modified in any way.
- The guarantee does not cover any products that have previously been on display in a showroom.
- The guarantee covers products in normal use. Faults or damage caused by neglect, misuse, wilful or accidental damage, inappropriate cleaning and incorrect installation are not covered under the guarantee.
- The guarantee covers UK installations only.

*Exceptions to the Abacus 15 Year Guarantee

* Glass seals are covered with a 1 year guarantee



Index

Elements Wetrooms

RAISED SHOWERING CONCEPT KITS	16
LEVEL ACCESS SHOWER TRAY KITS	26
LEVEL ACCESS 30mm SHOWER TRAY KITS	28
OVERBOARD FLOOR KITS	38
INFINITY SINGLE FALL WETROOM SYSTEM	42
STANDARD 40mm SHOWER TRAYS	48
LEVEL ACCESS 30mm SHOWER TRAYS	56
SHOWER WASTES & INSTALLATION KITS	68
ELEMENTS BESPOKE SHOWER TRAYS	70
ELEMENTS BUILDING BOARDS	86
SHOWER WALL PANELLING KITS	88
FLOOR & WALL TILE BACKER BOARDS	90
TILEABLE BATH PANELS & ACCESSORIES	94
WATERPROOF RECESSED STORAGE UNITS	96
PIPE BOXING & DECOR TRIMS	100
FIXINGS, ADHESIVES & SEALING COMPONENTS	104
SHOWER SEATING	108
COMPLETE SHOWER CUBICLES	110
BESPOKE & WELLNESS PRODUCTS	124
WETROOM GLASS	128
BESPOKE DOORS & PANELS	152

General

CARE & MAINTENANCE	156
PRODUCT GUARANTEE	156
TERMS AND CONDITIONS	159
ABACUS WETROOM DESIGN TIPS	160





Terms and conditions

1. INTERPRETATION

1.1 Definitions

In these Conditions, the following definitions apply:
Abacus: Abacus Direct Limited a company registered in England and Wales with company number 04331572 whose registered office is at Abacus House Jubilee Court, Copgrove, Harrogate, North Yorkshire, HG5 3TB.

Business Day: a day (other than a Saturday, Sunday or public holiday) when banks in London are open for business.

Conditions: the terms and conditions set out in this document as amended from time to time in accordance with condition 13.9 and all other documents referred to therein including, but not limited to, the Returns Policy and the Delivery Guide.
Contract: the contract between Abacus and the Customer for the sale and purchase of the Goods in accordance with these Conditions.

Customer: the person or firm who purchases the Goods from Abacus.

Delivery Guide: Abacus' guide to delivery costs and services which is available online at www.abacus-bathrooms.co.uk.

End-User: the person or firm to which the Customer re-sells the Goods.

Force Majeure Event: an event beyond the reasonable control of the affected party including but not limited to strikes, lock-outs or other industrial disputes (whether involving the workforce of the party or any other party), failure of a utility service or transport network, act of God, war, riot, civil commotion, malicious damage, compliance with any law or governmental order, fire, regulation or direction, accident, breakdown of plant or machinery, telecommunications failure (including problems with internet transmission) fire, flood, storm or default of suppliers or subcontractors.

Goods: the goods (or any part of them) set out in the Order.

OEM Branding: the OEM Customer's brand.

OEM Customer: a Customer who requests Abacus to manufacture the Goods to include OEM Branding.

Order: the Customer's order for the Goods that can be placed either by email, telephone, fax or such other electronic means as Abacus and the Customer may agree from time to time.

Product Portfolio: Abacus' catalogue listing all the Goods supplied by Abacus and setting out the description of the Goods, the prices and the Product Warranty as may be amended or updated by Abacus from time to time.

Product Warranty: the warranty provided by Abacus (or the manufacturer of the Goods) in respect of each of the Goods as set out in the Product Portfolio.

Returns Policy: Abacus' returns policy which is available online at www.abacus-bathrooms.co.uk.

Services: dealing with enquiries or complaints raised by End-Users, the processing of returns of Goods and/or showroom design and fitting services.

Specification: any specification for the Goods, including OEM Branding and any related plans and drawings that is agreed in writing by the Customer and Abacus.

VAT: value added tax.

Warranty Period: has the meaning set out in condition 5.1.

Website: Abacus' website at www.abacusedirecttd.com.

1.2 Construction

In these Conditions, the following rules apply:

1.2.1 A person includes a natural person, corporate or unincorporated body (whether or not having separate legal personality).

1.2.2 A reference to a party includes its personal representatives, successors or permitted assigns.

1.2.3 A reference to a statute or statutory provision is a reference to such statute or provision as amended or re-enacted. A reference to a statute or statutory provision includes any subordinate legislation made under that statute or statutory provision, as amended or re-enacted.

1.2.4 Any phrase introduced by the terms including, include, in particular or any similar expression shall be construed as illustrative and shall not limit the sense of the words preceding those terms.

1.2.5 A reference to writing or written includes faxes and e-mails.

2. BASIS OF CONTRACT

2.1 These Conditions apply to the Contract to the exclusion of any other terms that the Customer seeks to impose or incorporate, or which are implied by trade, custom, practice or course of dealing.

2.2 The Order constitutes an offer by the Customer to purchase the Goods in accordance with these Conditions. The Customer is responsible for ensuring that the terms of the Order and any applicable Specification submitted by the Customer are complete and accurate.

2.3 The Order shall only be deemed to be accepted when Abacus issues a written order acknowledgement, at which point the Contract shall come into existence.

2.4 The Contract constitutes the entire agreement between the parties. The Customer acknowledges that it has not relied on any statement, promise, representation, assurance or warranty made or given by or on behalf of Abacus which is not set out in the Contract.

2.5 Any samples, drawings, descriptive matter, or advertising produced by Abacus and any descriptions or illustrations contained in the Product Portfolio and/or the Website are produced for the sole purpose of giving an approximate idea of the Goods described in them. They shall not form part of the Contract or have any contractual force.

3. GOODS

3.1 The Goods are described in the Product Portfolio and the Website as modified by any applicable Specification.

3.2 To the extent that the Goods are to be manufactured in accordance with a Specification supplied by the Customer, the Customer shall indemnify Abacus against all liabilities, costs, expenses, damages and losses (including any direct, indirect or consequential losses, loss of profit, loss of reputation and all interest, penalties and legal and other professional costs and expenses) suffered or incurred by Abacus in connection with any claim made against Abacus for actual or alleged infringement of a third party's intellectual property rights arising out of or in connection with Abacus' use of the Specification. This condition 3.2 shall survive termination of the Contract.

3.3 Abacus reserves the right to amend the Specification if required by any applicable statutory or regulatory requirements.

4. DELIVERY

4.1 All deliveries shall be carried out in accordance with this condition 4 and the Delivery Guide.

4.2 Abacus shall deliver the Goods to the location set out in the Order or such other location as the parties may agree (Delivery Location).

4.3 Delivery of the Goods shall be completed on the Goods' arrival at the Delivery Location.

4.4 On delivery, the Customer shall check the Goods. If the Goods were damaged during transport or delivery, or if the quantity of Goods delivered is different to the quantity of Goods ordered, then the Customer must report any issues to Abacus' sales office as soon as possible and in any event no later than 2 Business Days after delivery.

4.5 Any dates quoted for delivery are approximate only, and the time of delivery is not of the essence. Abacus shall not be liable for any delay in delivery of the Goods that is caused by a Force Majeure Event or the Customer's failure to provide Abacus with adequate delivery instructions or any other instructions that are relevant to the supply of the Goods.

4.6 If Abacus fails to deliver the Goods, its liability shall be limited to the costs and expenses incurred by the Customer in obtaining replacement goods of similar description and quality in the cheapest market available, less the price of the Goods. Abacus shall have no liability for any failure to deliver the Goods to the extent that such failure is caused by a Force Majeure Event or the Customer's failure to provide Abacus with adequate delivery instructions or any other instructions that are relevant to the supply of the Goods.

4.7 If the Customer fails to accept delivery of the Goods within three Business Days of Abacus notifying the Customer that the Goods are ready, then, except where such failure or delay is caused by a Force Majeure Event or Abacus' failure to comply with its obligations under the Contract:

4.7.1 delivery of the Goods shall be deemed to have been completed at 9.00 am on the third Business Day after the day on which Abacus notified the Customer that the Goods were ready; and

4.7.2 Abacus shall store the Goods until delivery takes place, and charge the Customer for all related costs and expenses (including insurance).

4.8 If 10 Business Days after the day on which Abacus notified the Customer that the Goods were ready for delivery the Customer has not accepted delivery of them, Abacus may resell or otherwise

dispose of part or all of the Goods and, after deducting reasonable storage and selling costs, account to the Customer for any excess over the price of the Goods or charge the Customer for any shortfall below the price of the Goods.

4.9 Abacus may deliver the Goods by instalments, which shall be invoiced and paid for separately. Each instalment shall constitute a separate Contract. Any delay in delivery or defect in an instalment shall not entitle the Customer to cancel any other instalment.

5. QUALITY

5.1 Abacus warrants that on delivery, and for the period specified by each Product Warranty (warranty period), the Goods shall:

5.1.1 conform in all material respects with their description and any applicable Specification;

5.1.2 be of satisfactory quality; and

5.1.3 be fit for any purpose held out by Abacus.

5.2 Subject to condition 5.3, if:

5.2.1 the Customer gives notice in writing to Abacus during the warranty period within a reasonable time of discovery that some or all of the Goods do not comply with the warranty set out in condition 5.1;

5.2.2 Abacus is given a reasonable opportunity of examining such Goods; and

5.2.3 the Customer (if asked to do so by Abacus) returns such Goods to the Abacus' place of business at the Customer's cost, Abacus shall, at its option, repair or replace the defective Goods, or refund the price of the defective Goods in full.

5.3 Abacus shall not be liable for any failure of the Goods to comply with the warranty set out in condition 5.1 in any of the following events:

5.3.1 the Customer makes any further use of such Goods after giving notice in accordance with condition 5.2;

5.3.2 the defect arises because the Customer failed to follow Abacus' oral or written instructions as to the storage, commissioning, installation, use and maintenance of the Goods or (if there are none) good trade practice regarding the same;

5.3.3 the defect arises as a result of Abacus following any drawing, design or Specification supplied by the Customer;

5.3.4 the Customer alters or repairs such Goods without the written consent of Abacus;

5.3.5 the defect arises as a result of fair wear and tear, wilful damage, negligence, or abnormal storage or working conditions; or

5.3.6 the Goods differ from their description or the Specification as a result of changes made to ensure they comply with applicable statutory or regulatory requirements.

5.4 Except as provided in this condition 5.4, Abacus shall have no liability to the Customer in respect of the Goods' failure to comply with the warranty set out in condition 5.1.

5.5 These Conditions shall apply to any repaired or replacement Goods supplied by Abacus and should be read in conjunction with the Returns Policy.

6. TITLE AND RISK

6.1 The risk in the Goods shall pass to the Customer on completion of delivery.

6.2 Title to the Goods shall not pass to the Customer until the earlier of:

6.2.1 Abacus receives payment in full (in cash or cleared funds) for the Goods and any other goods that Abacus has supplied to the Customer in respect of which payment has become due, in which case title to the Goods shall pass at the time of payment of all such sums; and

6.2.2 the Customer resells the Goods, in which case title to the Goods shall pass to the Customer at the time specified in condition 6.4.

6.3 Until title to the Goods has passed to the Customer, the Customer shall:

6.3.1 store the Goods separately from all other goods held by the Customer so that they remain readily identifiable as Abacus' property;

6.3.2 not remove, deface or obscure any identifying mark or packaging on or relating to the Goods;

6.3.3 maintain the Goods in satisfactory condition and keep them insured against all risks for their full price from the date of delivery;

6.3.4 notify Abacus immediately if it becomes subject to any of the events listed in condition 10.1; and

6.3.5 give Abacus such information relating to the Goods as Abacus may require from time to time.

6.4 Subject to condition 6.5, the Customer may resell or use the Goods in the ordinary course of its business (but not otherwise) before Abacus receives payment for the Goods. However, if the Customer resells the Goods before that time:

6.4.1 it does so as principal and not as Abacus agent; and

6.4.2 title to the Goods shall pass from Abacus to the Customer immediately before the time at which resale by the Customer occurs.

6.5 If before title to the Goods passes to the Customer the Customer becomes subject to any of the events listed in condition 10.1, then, without limiting any other right or remedy Abacus may have:

6.5.1 the Customer's right to resell the Goods or use them in the ordinary course of its business ceases immediately; and

6.5.2 Abacus may at any time:

6.5.2.1 require the Customer to deliver up all Goods in its possession which have not been resold, or irrevocably incorporated into another product; and

6.5.2.2 if the Customer fails to do so promptly, enter any premises of the Customer or of any third party where the Goods are stored in order to recover them.

7. PRICE AND PAYMENT

7.1 The price of the Goods shall be the price set out in the Order; or, if no price is quoted, the price set out in the Product Portfolio as at the date of delivery.

7.2 Abacus may, by giving notice to the Customer at any time before delivery, increase the price of the Goods to reflect any increase in the cost of the Goods that is due to:

7.2.1 any factor beyond Abacus' control (including foreign exchange fluctuations, increases in taxes and duties, and increases in labour, materials and other manufacturing costs);

7.2.2 any request by the Customer to change the delivery date(s), quantities or types of Goods ordered, or the Specification; or

7.2.3 any delay caused by any instructions of the Customer or failure of the Customer to give Abacus adequate or accurate information or instructions.

7.3 The price of the Goods is exclusive of the costs and charges of packaging, transport of the Goods (which are set out in the Delivery Guide) and insurance, which shall be invoiced to the Customer.

7.4 The price of the Goods is exclusive of amounts in respect of VAT. The Customer shall, on receipt of a valid VAT invoice from Abacus, pay to Abacus such additional amounts in respect of VAT as are chargeable on the supply of the Goods.

7.5 Abacus may invoice the Customer for the Goods on or at any time after the completion of delivery.

7.6 Payment terms will be agreed in writing by Abacus and the Customer and confirmed in the written order acknowledgement. Abacus shall not be obliged to offer credit terms, and credit terms may be revoked at any time. Payment shall be made to a bank account nominated in writing by Abacus. Time of payment is of the essence.

7.7 If Abacus and the Customer agree any volume rebate or other discount, the Customer agrees that Abacus' calculations of such rebate or discount will be final and binding.

7.8 The Customer shall pay all amounts due under the Contract in full without any set-off, counterclaim, deduction or withholding (except for any deduction or withholding required by law). Abacus may at any time, without limiting any other rights or remedies it may have, set off any amount owing to it by the Customer against any amount payable by Abacus to the Customer.

8. INTELLECTUAL PROPERTY - OEM CUSTOMERS

8.1 All OEM Customers hereby grant Abacus a non-exclusive licence to use the OEM Branding and any other Intellectual Property Rights necessary to manufacture and supply the Goods in accordance with any Specification.

8.2 Abacus acknowledges and agrees that all rights in the OEM Branding and other relevant Intellectual Property Rights belonging to the OEM Customer shall remain in the OEM Customer.

9. SERVICES

9.1 If requested by the Customer and agreed in writing by Abacus, Abacus may supply the Services.

9.2 Abacus shall use all reasonable endeavours to meet any performance dates agreed between the parties, but any such dates shall be estimates only and time shall not be of the essence for performance of the Services.

9.3 Abacus shall have the right to make any changes to the services which are necessary to comply with any applicable law or safety requirement, or which do not materially affect the nature or quality of the Services, and Abacus shall notify the Customer in any such event.

9.4 Abacus warrants to the Customer that the Services will be provided using reasonable care and skill.

10. TERMINATION AND SUSPENSION

10.1 Abacus may terminate the Contract without liability immediately on giving notice to the Customer, if the Customer:

10.1.1 commits a material breach of its obligations under this Contract and (if such breach is remediable) fails to remedy that breach within a period of 30 days after receipt of written notice requiring it to do so;

10.1.2 commits a series of persistent minor breaches which, when taken together, amount to a material breach;

10.1.3 (being a natural person) is deemed either unable to pay its debts or as having no reasonable prospect of so doing, in either case, within the meaning of section 268 of the Insolvency Act 1986 or (being a partnership) has any partner to whom any of the foregoing apply;

10.1.4 (being a natural person) is declared bankrupt or makes any arrangement with or for the benefit of his creditors or has a county court administration order made against him under the County Court Act 1984;

10.1.5 enters into compulsory or members voluntary liquidation or passes a resolution for voluntary winding up or its directors convene a meeting of shareholders for that purpose (save for the purposes of solvent amalgamation or reconstruction where the amalgamated or reconstructed company agrees to adhere to this agreement);

10.1.6 has an administrative receiver or receiver appointed over all or any part of its assets or undertaking;

10.1.7 suspends, or threatens to suspend, payment of its debts, is unable to pay its debts as they fall due, admits inability to pay its debts or (being a partnership) has any partner to whom any of the foregoing apply or who is declared bankrupt;

10.1.8 is the subject of any judgment or order made against it or is the subject of any execution, distress, sequestration or other process levied upon or enforced against any of its assets;

10.1.9 has any action, step, legal proceedings or other procedure taken in respect of it by its directors, shareholders, bankers, creditors or any person seeking to appoint a liquidator or an administrator or takes any such act or step itself;

10.1.10 ceases or threatens to cease to carry on business; or

10.1.11 any event occurs, or proceeding is taken, with respect to the other party in any jurisdiction to which it is subject that has an effect equivalent or similar to any of the events mentioned in Condition 10.1.3 to Condition 10.1.9.

10.2 Without limiting its other rights or remedies, Abacus may suspend provision of the Goods under the Contract or any other contract between the Customer and Abacus if the Customer becomes subject to any of the events listed in condition 10.1.3 to condition 10.1.9, or Abacus reasonably believes that the Customer is about to become subject to any of them, or if the Customer fails to pay any amount due under this Contract on the due date for payment.

10.3 On termination of the Contract for any reason the Customer shall immediately pay to Abacus all of Abacus' outstanding unpaid invoices and interest.

10.4 Termination of the Contract, however arising, shall not affect any of the parties' rights, remedies, obligations and liabilities that have accrued as at termination.

10.5 Conditions which expressly or by implication survive termination of the Contract shall continue in full force and effect.

11. LIMITATION OF LIABILITY

11.1 Nothing in these Conditions shall limit or exclude Abacus' liability for:

11.1.1 death or personal injury caused by its negligence, or the negligence of its employees, agents or subcontractors (as applicable);

11.1.2 fraud or fraudulent misrepresentation; or

11.1.3 any matter in respect of which it would be unlawful for Abacus to exclude or restrict liability.

11.2 Subject to condition 11.1:

11.2.1 Abacus shall under no circumstances whatever be liable to the Customer, whether in contract, tort (including negligence), breach of statutory duty, or otherwise, for any loss of profit, or any indirect or consequential loss arising under or in connection with the Contract; and

11.2.2 Abacus' total liability to the Customer in respect of all other losses arising under or in connection with the Contract, whether in contract, tort (including negligence), breach of statutory duty, or otherwise, shall in no circumstances exceed the price of the Goods.

12. PRODUCT WITHDRAWAL/RECALL

12.1 Abacus shall notify the Customer as soon as practicable of any product withdrawal or recall relating to the Goods.

12.2 If Abacus decides to withdraw or recall any of the Goods, the Customer shall co-operate fully and promptly with any request by Abacus in respect of such withdrawal or recall.

12.3 Risk and title in the Goods shall pass to Abacus at the time the decision is made to withdraw or recall.

13. GENERAL

13.1 Abacus may assign the Contract or any part of it to any person, firm or company. Abacus shall use all reasonable endeavours to notify the Customer prior to making any such assignment. The Customer shall not be entitled to assign the Contract or any part of it without the prior written consent of Abacus and on such terms as Abacus shall reasonably specify.

13.2 Abacus maintains the right to employ any sub-contractor.

13.3 Notices under these Conditions shall be given in writing and may be given by delivery or first class post to the Customer at the address stated in the Order or as otherwise notified and to Abacus at the address stated in these Conditions or as other address notified. Notices sent by first class post shall be deemed to have been received within forty-eight hours of posting. Notices delivered by hand shall be deemed to have been received at the time of delivery.

13.4 No failure or delay by a party to exercise any right or remedy provided under this agreement or by law shall constitute a waiver of that or any other right or remedy.

13.5 If any court or competent authority finds that any provision of these Conditions (or part of any provision) is invalid, illegal or unenforceable, that provision or part-provision shall, to the extent required, be deemed to be deleted, and the validity and enforceability of the other provisions of these Conditions shall not be affected.

13.6 If any invalid, unenforceable or illegal provision of these Conditions would be valid, enforceable and legal if some part of it were deleted, the provision shall apply with the minimum modification necessary to make it legal, valid and enforceable.

13.7 Nothing in these Conditions is intended to, or shall be deemed to, constitute a partnership or joint venture of any kind between any of the parties, nor constitute any party the agent of another party for any purpose. No party shall have authority to act as agent for, or to bind, the other party in any way.

13.8 A person who is not a party to the Contract shall not have any rights under or in connection with it.

13.9 Except as set out in these Conditions, any variation, including the introduction of any additional terms and conditions, to the Contract, shall only be binding when agreed in writing and signed by Abacus.

13.10 The Contract shall be governed by, and construed in accordance with, English law, and the parties irrevocably submit to the exclusive jurisdiction of the English courts.

Abacus suggested wetroom design tips

1. The installation of a wetroom can create a modern, designer look to any bathroom and, if carefully planned and properly installed, add real value to your home. Plan your wetroom carefully. Many people talk about having a 'wetroom' but what they really want is a wet area within a bathroom, where the water is contained by some form of screen.
2. It is important to plan the exact location of the wet area within the room and the type of screen required to contain the water. The screen could be a tiled wall, a piece or pieces of glass, or a combination of both wall and glass. The size of the wall or glass panel is also very important. It needs to be large enough to contain the water and you may need to consider a glass panel with a 350mm return panel to effectively contain the water in the wet area.
3. Take into account the floor substrate upon which you wish to install a wet area. If it's a solid or concrete floor, you may need to include a raised area in which to house the drain and waste. A 40mm high shower tray with 90mm sub-element is perfect for this type of installation and creates a raised wet zone.
4. If the wet area is housed on a timber floor, and the drain and waste can be sited in the void beneath the floorboards, then there is an option to install either a 40mm high, low level wet zone shower base or a 30mm level access shower tray. The level access solution makes for a 'seamless look' to the floor without the need to step up into a shower tray.
5. Carefully consider the placement of the drain within the shower tray. If the drain placement is a problem within your installation, we can make a bespoke shower tray solution to suit your needs.
6. Due to the very nature of a wetroom being wet, we would recommend the entire installation area be properly waterproofed prior to tiling. This includes the floor and walls and our Elements waterproofing boards and installation kits will, if properly installed, guarantee a perfectly waterproof environment, protecting your investment for years to come.
7. Wetrooms are also ideal environments for the installation of under-tile heating. This is very controllable in both winter and summer and offers a luxurious warm feeling underfoot as well as helping to control condensation, thereby enhancing the life of your bathroom.

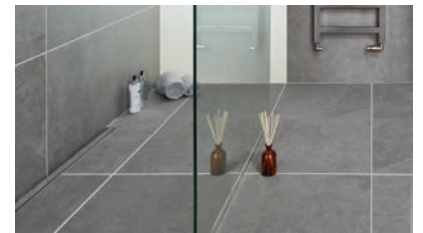
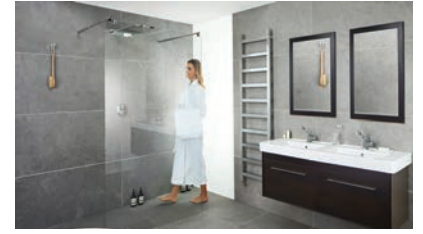

Design your wetroom

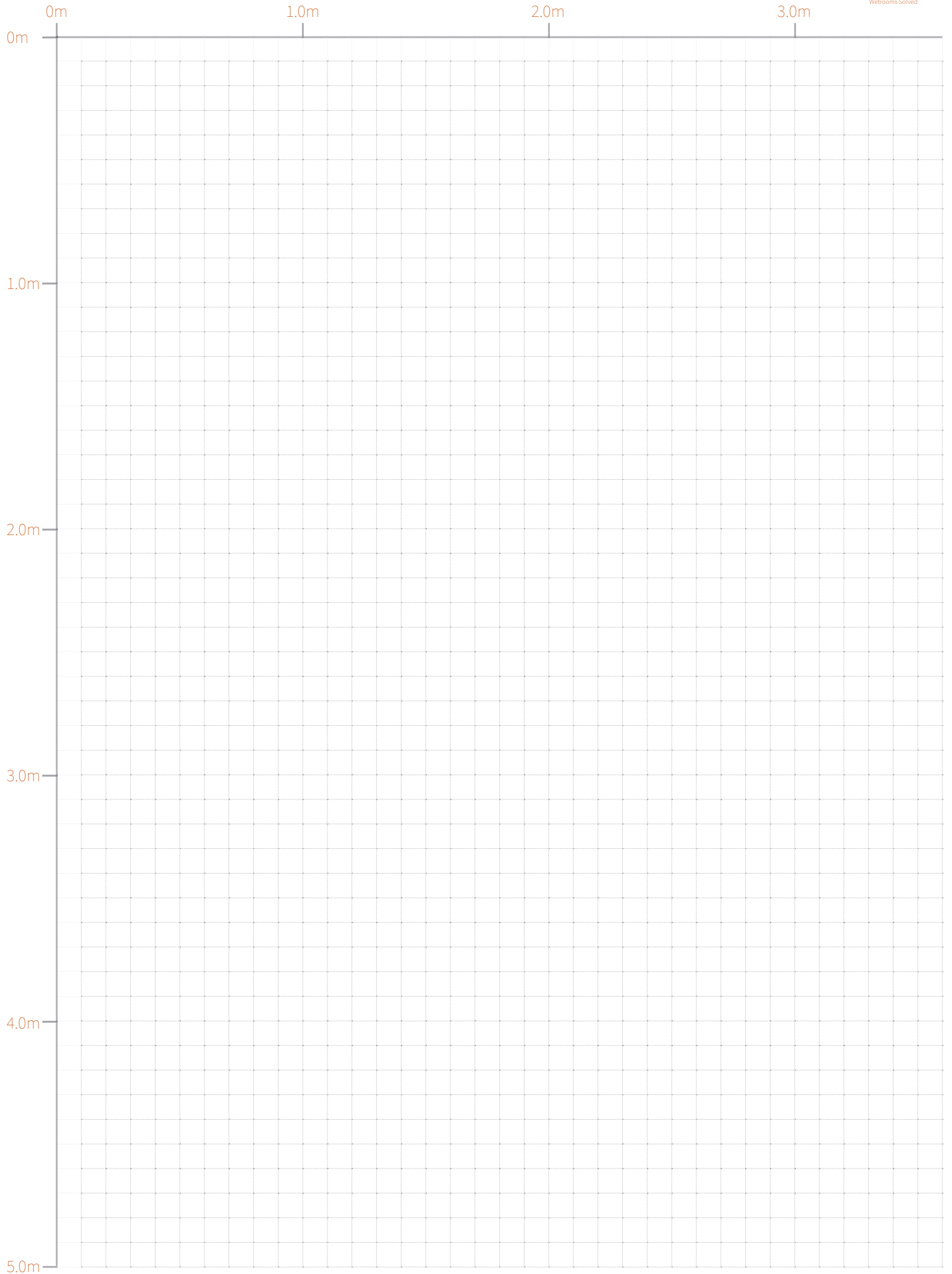



Tel: +44 (0) 345 850 50 40

Fax: +44 (0) 345 850 50 30

Sales:

sales@abacus-bathrooms.co.uk

General enquiries:

enquiries@abacus-bathrooms.co.uk

Abacus
Abacus House
Jubilee Court
Copgrove
Harrogate
HG3 3TB
UK

www.abacus-bathrooms.co.uk



MMBR-75-1705

Version 1.0

All information correct at time of going to print.
E&OE. Prices subject to change without prior notice.
Colours printed in this catalogue are as accurate as the
printing process allows and are for guidance only.

designed and produced by PridDesign
www.priddesign.co.uk