

ROMAN[®]

REFINED SHOWERING



www.roman-showers.com

July
2022



At the heart of Roman is the desire to be the best.

It is Roman's vision to lead and innovate in the Showering industry.

To design and manufacture top quality inspirational showering solutions,
which offers choice for all markets.

To expertly manufacture our products in Britain, so they are designed
and built to last and offer a lifetime of effortless showering for all. It is our
aim to give all our customers exceptional value and service; this ethos
runs throughout the culture of the business and cannot be imitated.

We are now certified as Carbon Neutral and we will constantly strive to
further improve and enhance our environmental impact.

“ Great brands always balance
identity, integrity and efficiency ”

- Matteo Ferrara

Who we are

ROMAN has been designing and manufacturing showering solutions for over 36 years, and is home to the UK's largest shower manufacturing plant. All Roman products are designed and created in Britain, offering the ultimate in quality, precision and craftsmanship. Roman's diverse and versatile collection of products encompasses something for every style and shape bathroom – no matter what the budget.

Highest Quality Materials

Roman only use the finest quality of materials to guarantee unsurpassed quality and certainty in our manufacturing process, ensuring all of our products reach exceptional levels of style and performance. We carefully fabricate and anodise all our aluminium profiles. We use aluminium because it is; light, strong and requires minimal maintenance. The anodising process increases corrosion resistance, product durability and further enhances the material properties. Our specialist anodising offers a bright chrome like finish which is significantly in excess of standard aluminium finishing.

Roman Stone shower trays are manufactured from solid surface and are inherently anti-slip and carry the highest national standard of DIN. Roman's Anti-Slip shower trays combine luxury and durability and add value to the shower tray market.

Glass

All our enclosures feature toughened safety glass. This is a heat treatment to increase the glass strength to make it around 5 times stronger than normal glass. If the glass were to break due to impact, it would shatter into lots of small pieces which are much less dangerous and will help you avoid any cuts or injury. All glass is strictly tested in accordance with EN14428

Products Designed for All

Innovation and exceptional product design differentiates Roman from the competition. Our products are carefully designed for all. We consider different users' needs to give totally effortless entry to the entire family. Whether you would like door-less entry, level access, handles that can be used with a flat hand, or a wider aperture, we have something that will work with your space all finished with a stylish designer look.

Customer Service

Roman has an in-house customer support network, who are there to offer advice and support for each purchase at every stage; from initial enquiry through to after sales care advice. Roman employs over 20 full time members of staff in our Customer Support Centre and over 40 Technical Service Representatives nationwide who all receive comprehensive training on the manufacture and installation of Roman's collection of products.

Branding

Roman is a reputable and well established UK Brand, now supplying showering products all over the World. Our foundations are strongly rooted in; innovative design, manufacture, quality and customer service. Roman has achieved the leading position in the Market place by consistent and creative product innovation and has produced growth across all UK Market sectors and strong growth in 60 International Markets. Our products are used in some of the finest hotels Worldwide.



Award Winning

Manufacturing & Innovation

Our products and ranges have won multiple awards including The Queens Award for Enterprise - International Trade, in 2017 and again in 2022..

We have also been identified as one of London Stock Exchange's 1000 Companies to Inspire Britain. We are extremely proud to be recognised as one of the UK's fastest growing and most dynamic small and medium sized businesses.

Roman is included in the FT1000, which is the list of Europe's Fastest Growing Companies, compiled by the Financial Times. We have also been awarded the Bathroom Safety Compliance Award 2018 by the NHIC.



Winner of the Bathroom Manufacturer Association
Circular Economy Award November 2021

Trust

Buy with Confidence

All Roman products are designed and created in the UK, offering the ultimate in quality, precision and craftsmanship. All Roman's manufacturing processes are carried out at our UK Manufacturing Plant and Headquarters and meet and exceed approved UK and European testing standards.

For complete peace of mind, all Roman Shower Enclosures and Bath Screens are accompanied by a fully service backed Truelife Lifetime Guarantee.



Inspiration

Helping you to design your bathroom

Roman products are available on the Virtual Worlds design service. For more information contact Roman Customer Relations 01325 328033

For project applications Roman products are available as a BIM file download from: www.roman-showers/available-downloads.com

Making your product selection easier. Roman products are available on EQ software. For more information contact Customer Relations on 01325 328033.



Protection

All glass pre-coated

All Roman's enclosures and bath screens are pre-coated with Roman Ultra Care, our own unique glass protection system. (For full details see page 119)

All Roman products are designed and manufactured to present easy cleaning ability to ensure your Roman showering experience lasts for many years.



Pricing - VAT is calculated at 20% rate.

Roman have an ongoing policy of design, development and improvement and thus reserve the right to modify specification, ranges and prices without prior notice. Images are for illustration purposes only - please refer to your retailer as site conditions will vary or contact Roman Customer Relations on 01325 328033 for installation specifications.

Door Styles

Quadrant

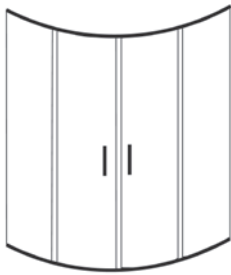

The Quadrant shaped enclosure will sit beautifully in the corner of your bathroom, making it an ideal solution for the smaller bathroom. It incorporates unobtrusive sliding doors.

Sliding Door

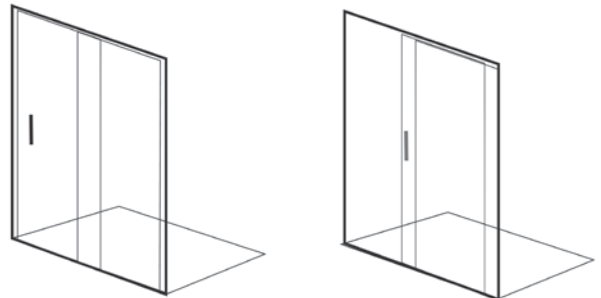

The sliding door action offers wide and easy access, with no protrusion into the bathroom or showering area.

Neo-Angle



This flexible design allows for inward or outward opening door entry. It presents a unique footprint, to work around existing fixtures and fittings.

Bi-Fold Door

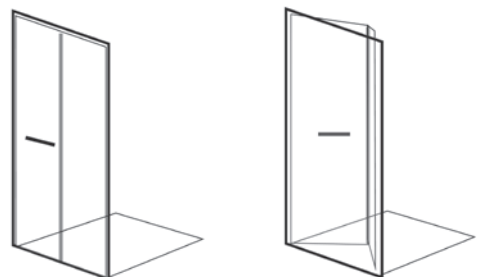

Inward opening door presents a flexible space saving solution. Avoids existing fixtures and fittings in the bathroom area.

Pivot Doors

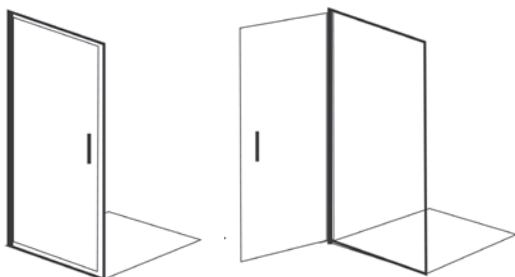

Outward opening door, takes up minimal external space due to the positioning of the hinge point, meaning it protrudes less into the bathroom space.

Hinged Doors

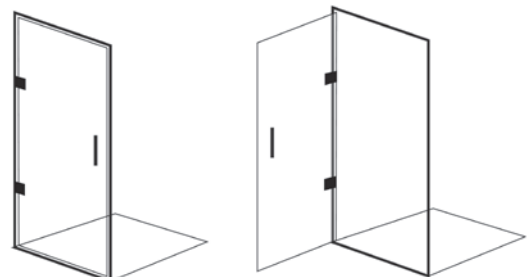

Smooth outward opening door, featuring soft self-close hinges for a superior finish.

For Wetroom Panel styles see pages 56 - 85

Contents

Liberty

8mm & 10mm
Frameless Hinged and Sliding

Pages 8 - 29

Bath Screens

Pages 96 - 115

Innov8

8mm Frameless

Pages 30 - 45

Accessories and Product After Care

Pages 116 - 119

Embrace

6mm & 8mm Semi-Frameless

Pages 46 - 55

Environment

Page 120 - 121

Wetrooms

including Select Panels

8mm and 10mm Glass Options

Pages 56 - 85

Bespoke Service

Page 122

Shower Trays

Pages 86 - 95

Guarantee Information

Page 123



“ Colour does not add a pleasant quality to design - it reinforces it. ”
- Pierre Bonard



1200 x 800 Sliding Door with fluted glass in polished nickel finish
See page 11 for details

What will your colour be...?

Colour options for hardware



Matt Black



Polished Chrome



Brushed Nickel



Polished Nickel



Brushed Brass

Liberty

Sliding Door

with Fluted Glass



1200 Alcove Fitting - Polished Nickel finish with fluted glass
Left Hand Sliding Door: KTID12FLPN
1200 x 800 Anti-Slip Tray: RST128

“ Revolutionary minimalist sliding styling ”







1200 x 800 Corner Fitting - with Polished Nickel finish and fluted glass
 Right Hand Sliding Door Side Panel: KTR1C8FRPN and KT1D12FRCPN
 1200 x 800 Matt White Anti-Slip Tray: RST128

GLASS THICKNESS 8 Millimetres	TOTAL HEIGHT 2000 Millimetres	GLASS PROTECTION ULTRA CARE BY ROMAN	TRULIFE LIFETIME GUARANTEE
--	--	---	--------------------------------------

- Quick release door function for easy cleaning
- Barrier free entry option
- Silent and ultra-smooth running roller bearing system
- Soft cushioned close system
- Choice of colour finishes available
- Beautifully styled corner joints
- Compatible trays available

Colour options for hardware:

				
Matt Black add B to codes	Chrome add S to codes	Brushed Nickel add N to codes	Polished Nickel add PN to codes	Brushed Brass add BR to codes

Please note: Handing must be specified for the correct codes to be ordered

Add your preferred colour letter to codes

Corner Fitting

Glass (mm)	Enclosure Size (mm)	Handing	Adjustment (mm)	Aperture (mm)	Door Code	Side Panel Code	Total Cost ex VAT	Total Cost inc VAT
8	1200 x 800	Left Hand	1173 - 1187 & 773 - 787	500	KT1D12FLC	KTR1C8FL	£2953.92	£3544.70
8	1200 x 800	Right Hand	1173 - 1187 & 773 - 787	500	KT1D12FRC	KTR1C8FR	£2953.92	£3544.70
8	1200 x 900	Left Hand	1173 - 1187 & 873 - 887	500	KT1D12FLC	KTR1C9FL	£3019.00	£3622.80
8	1200 x 900	Right Hand	1173 - 1187 & 873 - 887	500	KT1D12FRC	KTR1C9FR	£3019.00	£3622.80

Alcove Fitting

Glass (mm)	Enclosure Size (mm)	Handing	Adjustment (mm)	Aperture (mm)	Door Code	Total Cost ex VAT	Total Cost inc VAT
8	1200	Left Hand	1166 - 1194	499	KT1D12FL	£1852.26	£2222.71
8	1200	Right Hand	1166 - 1194	499	KT1D12FR	£1852.26	£2222.71

Compatible Trays	Page
Roman Anti-Slip Trays	88 - 89
Roman Infinity Trays	90 - 91
Roman Low Level Trays	94 - 95

Liberty

Sliding Door

with Clear Glass for Alcove Fitting



1200 Alcove Fitting
with Brushed Nickel finish

Right Hand Door: KT1D12RN

1200 x 800 Anti-Slip Tray: RST128

Features and Benefits



Quick release door function for easy cleaning

Barrier free entry option

Silent and ultra-smooth running roller bearing system

Soft cushioned close system

Choice of colour finishes available

Beautifully styled corner joints

Compatible trays available



1200 Alcove Fitting
with Matt Black finish

Right Hand Door: KT1D12RB

1200 x 800 Anti-Slip Tray: RST128

Colour options for hardware:



Matt Black
add B
to codes

Chrome
add S
to codes

Brushed Nickel
add N
to codes

Polished Nickel
add PN
to codes

Brushed Brass
add BR
to codes

Please note: Handing must be specified for the correct codes to be ordered

Add your preferred colour letter to codes

Alcove Fitting

Glass (mm)	Enclosure Size (mm)	Handing	Adjustment (mm)	Aperture (mm)	Door Code	Total Cost ex VAT	Total Cost inc VAT
8	1200	Left Hand	1166 - 1194	500	KT1D12L	£1217.12	£1460.54
8	1200	Right Hand	1166 - 1194	500	KT1D12R	£1217.12	£1460.54
8	1400	Left Hand	1366 - 1394	600	KT1D14L	£1332.07	£1598.48
8	1400	Right Hand	1366 - 1394	600	KT1D14R	£1332.07	£1598.48
8	1500	Left Hand	1466 - 1494	650	KT1D15L	£1390.21	£1668.25
8	1500	Right Hand	1466 - 1494	650	KT1D15R	£1390.21	£1668.25
8	1700	Left Hand	1666 - 1694	750	KT1D17L	£1506.50	£1807.80
8	1700	Right Hand	1666 - 1694	750	KT1D17R	£1506.50	£1807.80
10	1200	Left Hand	1166 - 1194	500	TT1D12L	£1363.15	£1635.78
10	1200	Right Hand	1166 - 1194	500	TT1D12R	£1363.15	£1635.78
10	1400	Left Hand	1366 - 1394	600	TT1D14L	£1491.90	£1790.28
10	1400	Right Hand	1366 - 1394	600	TT1D14R	£1491.90	£1790.28
10	1500	Left Hand	1466 - 1494	650	TT1D15L	£1557.02	£1868.42
10	1500	Right Hand	1466 - 1494	650	TT1D15R	£1557.02	£1868.42
10	1700	Left Hand	1666 - 1694	750	TT1D17L	£1687.29	£2024.75
10	1700	Right Hand	1666 - 1694	750	TT1D17R	£1687.29	£2024.75

Compatible Trays	Page
Roman Anti-Slip Trays	88 - 89
Roman Infinity Trays	90 - 91
Roman Low Level Trays	94 - 95

Liberty

Sliding Door

with Clear Glass for Corner Fitting



1700 x 800 Corner Fitting
with Matt. Black finish
Right Hand Door and Side Panel:
KT1D17RCB and KTR1C8B
1700 x 800 Matt. White Anti-Slip Tray:
RST178

“ Beautifully styled
curved corner joints ”

Features and Benefits



Quick release door function for easy cleaning

Barrier free entry option

Silent and ultra-smooth running roller bearing system

Soft cushioned close system

Choice of colour finishes available

Beautifully styled corner joints

Compatible trays available

Colour options for hardware:

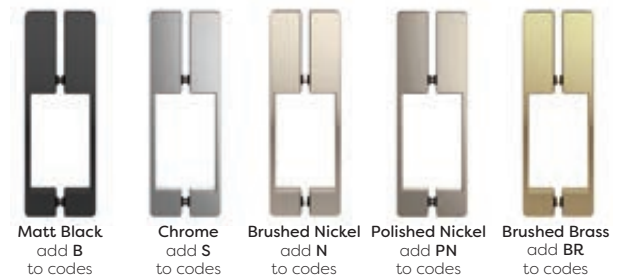

Please note: Handing must be specified for the correct codes to be ordered

Add your preferred colour letter to codes

Corner Fitting

Glass (mm)	Enclosure Size (mm)	Handing	Adjustment (mm)	Aperture (mm)	Door Code	Side Panel Code	Total Cost ex VAT	Total Cost inc VAT
8	1200 x 800	Left Hand	1173 - 1187 & 773 - 787	500	KT1D12LC	KTR1C8	£1845.96	£2215.15
8	1200 x 800	Right Hand	1173 - 1187 & 773 - 787	500	KT1D12RC	KTR1C8	£1845.96	£2215.15
8	1200 x 900	Left Hand	1173 - 1187 & 873 - 887	500	KT1D12LC	KTR1C9	£1886.53	£2263.84
8	1200 x 900	Right Hand	1173 - 1187 & 873 - 887	500	KT1D12RC	KTR1C9	£1886.53	£2263.84
8	1400 x 800	Left Hand	1373 - 1387 & 773 - 787	600	KT1D14LC	KTR1C8	£1960.91	£2353.09
8	1400 x 800	Right Hand	1373 - 1387 & 773 - 787	600	KT1D14RC	KTR1C8	£1960.91	£2353.09
8	1400 x 900	Left Hand	1373 - 1387 & 873 - 887	600	KT1D14LC	KTR1C9	£2001.48	£2401.78
8	1400 x 900	Right Hand	1373 - 1387 & 873 - 887	600	KT1D14RC	KTR1C9	£2001.48	£2401.78
8	1500 x 800	Left Hand	1473 - 1487 & 773 - 787	650	KT1D15LC	KTR1C8	£2019.05	£2422.86
8	1500 x 800	Right Hand	1473 - 1487 & 773 - 787	650	KT1D15RC	KTR1C8	£2019.05	£2422.86
8	1500 x 900	Left Hand	1473 - 1487 & 873 - 887	650	KT1D15LC	KTR1C9	£2059.62	£2471.54
8	1500 x 900	Right Hand	1473 - 1487 & 873 - 887	650	KT1D15RC	KTR1C9	£2059.62	£2471.54
8	1700 x 800	Left Hand	1673 - 1687 & 773 - 787	750	KT1D17LC	KTR1C8	£2135.34	£2562.41
8	1700 x 800	Right Hand	1673 - 1687 & 773 - 787	750	KT1D17RC	KTR1C8	£2135.34	£2562.41
8	1700 x 900	Left Hand	1673 - 1687 & 873 - 887	750	KT1D17LC	KTR1C9	£2175.91	£2611.09
8	1700 x 900	Right Hand	1673 - 1687 & 873 - 887	750	KT1D17RC	KTR1C9	£2175.91	£2611.09
10	1200 x 800	Left Hand	1173 - 1187 & 773 - 787	500	TT1D12LC	TTR1C8	£2067.44	£2480.93
10	1200 x 800	Right Hand	1173 - 1187 & 773 - 787	500	TT1D12RC	TTR1C8	£2067.44	£2480.93
10	1200 x 900	Left Hand	1173 - 1187 & 873 - 887	500	TT1D12LC	TTR1C9	£2112.88	£2535.46
10	1200 x 900	Right Hand	1173 - 1187 & 873 - 887	500	TT1D12RC	TTR1C9	£2112.88	£2535.46
10	1400 x 800	Left Hand	1373 - 1387 & 773 - 787	600	TT1D14LC	TTR1C8	£2196.19	£2635.43
10	1400 x 800	Right Hand	1373 - 1387 & 773 - 787	600	TT1D14RC	TTR1C8	£2196.19	£2635.43
10	1400 x 900	Left Hand	1373 - 1387 & 873 - 887	600	TT1D14LC	TTR1C9	£2241.63	£2689.96
10	1400 x 900	Right Hand	1373 - 1387 & 873 - 887	600	TT1D14RC	TTR1C9	£2241.63	£2689.96
10	1500 x 800	Left Hand	1473 - 1487 & 773 - 787	650	TT1D15LC	TTR1C8	£2261.31	£2713.57
10	1500 x 800	Right Hand	1473 - 1487 & 773 - 787	650	TT1D15RC	TTR1C8	£2261.31	£2713.57
10	1500 x 900	Left Hand	1473 - 1487 & 873 - 887	650	TT1D15LC	TTR1C9	£2306.75	£2768.10
10	1500 x 900	Right Hand	1473 - 1487 & 873 - 887	650	TT1D15RC	TTR1C9	£2306.75	£2768.10
10	1700 x 800	Left Hand	1673 - 1687 & 773 - 787	750	TT1D17LC	TTR1C8	£2391.58	£2869.90
10	1700 x 800	Right Hand	1673 - 1687 & 773 - 787	750	TT1D17RC	TTR1C8	£2391.58	£2869.90
10	1700 x 900	Left Hand	1673 - 1687 & 873 - 887	750	TT1D17LC	TTR1C9	£2437.02	£2924.42
10	1700 x 900	Right Hand	1673 - 1687 & 873 - 887	750	TT1D17RC	TTR1C9	£2437.02	£2924.42

Compatible Trays	Page
Roman Anti-Slip Trays	88 - 89
Roman Infinity Trays	90 - 91
Roman Low Level Trays	94 - 95

Hinged Door



900 x 900 Corner Fitting with Chrome finish
Hinged Door and Side Panel: KL913CS and KR913S
900 x 900 Roman Low Level Tray: RLT90
Shower Basket: RSB01

Outward Opening

“ Door hinged straight from the wall for a sleek minimalist look ”

Features and Benefits



-
- Hinged from wall
-
- New clear and minimal seals
-
- New minimal easy fix wall profile system
-
- Choice of colour finishes available
-
- Integrated 'tray or floor' Water Safe System
-
- Designed for installation to straight vertical walls
-
- Compatible trays available
-



900 Alcove Fitting with Chrome finish
 Hinged Door: KL913S
 900 x 900 Roman Low Level Tray: RLT90
 Shower Basket: RSB02

Colour options for hardware:



Alcove Fitting - outward opening only

Add your preferred colour letter to codes

Glass (mm)	Description	Size (mm)	Adjustment (mm)	Aperture (mm)	Code	Cost ex VAT	Cost inc VAT
8	Hinged Door for Alcove	760	735 - 745	710	KL7613	£943.59	£1132.31
8	Hinged Door for Alcove	800	775 - 785	750	KL813	£952.87	£1143.44
8	Hinged Door for Alcove	900	875 - 885	850	KL913	£962.84	£1155.41
8	Hinged Door for Alcove	1000	975 - 985	950	KL1013	£972.36	£1166.83
10	Hinged Door for Alcove	760	735 - 745	710	TL7613	£1025.66	£1230.79
10	Hinged Door for Alcove	800	775 - 785	750	TL813	£1036.12	£1243.34
10	Hinged Door for Alcove	900	875 - 885	850	TL913	£1046.56	£1255.87
10	Hinged Door for Alcove	1000	975 - 985	950	TL1013	£1056.91	£1268.29

Please note - lead time of 3 - 4 weeks for alcove door

Corner Fitting - outward opening only

Add your preferred colour letter to codes

Glass (mm)	Description	Size (mm)	Adjustment (mm)	Aperture (mm)	Code	Cost ex VAT	Cost inc VAT
8	Hinged Door for Corner	760	0	720	KL7613C	£763.94	£916.73
8	Hinged Door for Corner	800	0	760	KL813C	£776.33	£931.60
8	Hinged Door for Corner	900	0	860	KL913C	£788.77	£946.52
8	Hinged Door for Corner	1000	0	960	KL1013C	£801.18	£961.42
8	Side Panel	760	733 - 747	-	KR7613	£763.94	£916.73
8	Side Panel	800	773 - 787	-	KR813	£776.33	£931.60
8	Side Panel	900	873 - 887	-	KR913	£788.77	£946.52
8	Side Panel	1000	973 - 987	-	KR1013	£801.18	£961.42
10	Hinged Door for Corner	760	0	720	TL7613C	£806.36	£967.63
10	Hinged Door for Corner	800	0	760	TL813C	£819.46	£983.35
10	Hinged Door for Corner	900	0	860	TL913C	£832.59	£999.11
10	Hinged Door for Corner	1000	0	960	TL1013C	£845.71	£1014.85
10	Side Panel	760	733 - 747	-	TR7613	£806.36	£967.63
10	Side Panel	800	773 - 787	-	TR813	£819.46	£983.35
10	Side Panel	900	873 - 887	-	TR913	£832.59	£999.11
10	Side Panel	1000	973 - 987	-	TR1013	£845.71	£1014.85

Compatible Trays	Page
Roman Anti-Slip Trays	88 - 89
Roman Infinity Trays	90 - 91
Roman Low Level Trays	94 - 95

Liberty

Hinged Door

With One In-line Panel



1000 Alcove Fitting with
Brushed Nickel finish

8mm Door and In-Line Panel:
KL1HD13N and KL1H1013N

Roman Low Level Tray: RLT108

Shower Basket: RSB02

Inward or Outward Opening

“ It presents you with the choice of brushed nickel, polished nickel, brushed brass, silver chrome or matt black finish on all components including the elongated sleek hinges, designer handle and bracing bar. ”

Features and Benefits



- Hinged from wall
- New clear and minimal seals
- New minimal easy fix wall profile system
- Adjustable hinges for Inward or Outward opening door
- Choice of colour finishes available
- Integrated 'tray or floor' Water Safe System
- Designed for installation to straight vertical walls
- Optional brace bar included



1200 x 900 Corner Fitting with Brushed Nickel finish

Hinged Door, In-Line Panel and Side Panel: KL1HDR13N, KL1HR1213N and KHR913N

Glass Infinity Tray: IAG129

Shower Basket: RSB02

Colour options for hardware:



Matt Black
add **B**
to codes

Chrome
add **S**
to codes

Brushed Nickel
add **N**
to codes

Polished Nickel
add **PN**
to codes

Brushed Brass
add **BR**
to codes

Corner Fitting Add your preferred colour letter to codes

Glass (mm)	Enclosure Size (mm)	Adjustment (mm)	Aperture (mm)	Door Code	In-Line Panel Code	Side Panel Code	Total Cost ex VAT	Total Cost inc VAT
8	1000 x 800	773 - 787	667	KL1HDR13	KL1HR1013	KHR813	£1801.10	£2161.32
8	1000 x 900	873 - 887	667	KL1HDR13	KL1HR1013	KHR913	£1863.22	£2235.86
8	1200 x 800	773 - 787	667	KL1HDR13	KL1HR1213	KHR813	£1987.42	£2384.90
8	1200 x 900	873 - 887	667	KL1HDR13	KL1HR1213	KHR913	£2049.54	£2459.45
8	1400 x 800	773 - 787	667	KL1HDR13	KL1HR1413	KHR813	£2049.55	£2459.46
8	1400 x 900	873 - 887	667	KL1HDR13	KL1HR1413	KHR913	£2111.67	£2534.00
8	1600 x 800	773 - 787	667	KL1HDR13	KL1HR1613	KHR813	£2235.86	£2683.03
10	1000 x 800	773 - 787	667	TL1HDR13	TL1HR1013	THR813	£1901.21	£2281.45
10	1000 x 900	873 - 887	667	TL1HDR13	TL1HR1013	THR913	£1966.76	£2360.11
10	1200 x 800	773 - 787	667	TL1HDR13	TL1HR1213	THR813	£2097.88	£2517.46
10	1200 x 900	873 - 887	667	TL1HDR13	TL1HR1213	THR913	£2163.43	£2596.12
10	1400 x 800	773 - 787	667	TL1HDR13	TL1HR1413	THR813	£2163.43	£2596.12
10	1400 x 900	873 - 887	667	TL1HDR13	TL1HR1413	THR913	£2228.98	£2674.78
10	1600 x 800	773 - 787	667	TL1HDR13	TL1HR1613	THR813	£2360.12	£2832.14

Alcove Fitting Add your preferred colour letter to codes

Glass (mm)	Enclosure Size (mm)	Adjustment (mm)	Aperture (mm)	Door Code	In-Line Panel Code	Total Cost ex VAT	Total Cost inc VAT
8	760	733 - 747	500	KL1HD213	KL1H7613	£1149.69	£1379.63
8	800	773 - 787	500	KL1HD213	KL1H813	£1161.42	£1393.70
8	900	873 - 887	640	KL1HD13	KL1H913	£1173.15	£1407.78
8	1000	973 - 987	640	KL1HD13	KL1H1013	£1290.47	£1548.56
8	1200	1173 - 1187	640	KL1HD13	KL1H1213	£1407.78	£1689.34
8	1400	1373 - 1387	640	KL1HD13	KL1H1413	£1525.10	£1830.12
8	1600	1573 - 1587	640	KL1HD13	KL1H1613	£1642.40	£1970.88
10	760	733 - 747	500	TL1HD213	TL1H7613	£1248.34	£1498.01
10	800	773 - 787	500	TL1HD213	TL1H813	£1311.15	£1573.38
10	900	873 - 887	640	TL1HD13	TL1H913	£1373.98	£1648.78
10	1000	973 - 987	640	TL1HD13	TL1H1013	£1442.28	£1730.74
10	1200	1173 - 1187	640	TL1HD13	TL1H1213	£1573.40	£1888.08
10	1400	1373 - 1387	640	TL1HD13	TL1H1413	£1704.51	£2045.41
10	1600	1573 - 1587	640	TL1HD13	TL1H1613	£1835.64	£2202.77



Compatible Trays	Page
Roman Anti-Slip Trays	88 - 89
Roman Infinity Trays	90 - 91
Roman Low Level Trays	94 - 95

Liberty

Hinged Door

With In-line Panel and Fluted Glass



1600 Alcove Fitting (Right Hand)
with Brushed Brass finish

Hinged Door and In-Line Panel:
KL1HDFRBR and KL1H16FRBR

1600 x 800 Anti-Slip Tray: RST168

Inward or Outward Opening

“ Feeling groovy ”

Features and Benefits



Hinged from wall

New clear and minimal seals

New minimal easy fix wall profile system

Adjustable hinges for Inward or Outward opening door

Choice of colour finishes available

Integrated 'tray or floor' Water Safe System

Designed for installation to straight vertical walls

Optional brace bar included

Compatible trays available



1400 x 900 Corner Fitting
(Left Hand) with Matt Black finish

Hinged Door, In-Line Panel and Side Panel:
KL1HDFRLB, KL1HR14FLB, KHR9FLB

1400 x 900 Anti-Slip Tray: RST149

Colour options for hardware:



Matt Black
add **B**
to codes

Chrome
add **S**
to codes

Brushed Nickel
add **N**
to codes

Polished Nickel
add **PN**
to codes

Brushed Brass
add **BR**
to codes

Left or Right handing must be specified when ordering

Corner Fitting

Add your preferred colour letter to codes

Glass (mm)	Enclosure Size (mm)	Handing	Adjustment (mm)	Aperture (mm)	Door Code	In-Line Panel Code	Side Panel Code	Total Cost ex VAT	Total Cost inc VAT
8	1200 x 800	Left Hand	773 - 787	667	KL1HDRFL	KL1HR12FL	KHR8FL	£3179.89	£3815.87
8	1200 x 800	Right Hand	773 - 787	667	KL1HDRFR	KL1HR12FR	KHR8FR	£3179.89	£3815.87
8	1200 x 900	Left Hand	873 - 887	667	KL1HDRFL	KL1HR12FL	KHR9FL	£3281.52	£3937.82
8	1200 x 900	Right Hand	873 - 887	667	KL1HDRFR	KL1HR12FR	KHR9FR	£3281.52	£3937.82
8	1400 x 800	Left Hand	773 - 787	667	KL1HDRFL	KL1HR14FL	KHR8FL	£3279.29	£3935.15
8	1400 x 800	Right Hand	773 - 787	667	KL1HDRFR	KL1HR14FR	KHR8FR	£3279.29	£3935.15
8	1400 x 900	Left Hand	873 - 887	667	KL1HDRFL	KL1HR14FL	KHR9FL	£3380.92	£4057.10
8	1400 x 900	Right Hand	873 - 887	667	KL1HDRFR	KL1HR14FR	KHR9FR	£3380.92	£4057.10
8	1600 x 800	Left Hand	773 - 787	667	KL1HDRFL	KL1HR16FL	KHR8FL	£3577.39	£4292.87
8	1600 x 800	Right Hand	773 - 787	667	KL1HDRFR	KL1HR16FR	KHR8FR	£3577.39	£4292.87
8	1600 x 900	Left Hand	873 - 887	667	KL1HDRFL	KL1HR16FL	KHR9FL	£3679.02	£4414.82
8	1600 x 900	Right Hand	873 - 887	667	KL1HDRFR	KL1HR16FR	KHR9FR	£3679.02	£4414.82

Left or Right handing must be specified when ordering

Alcove Fitting

Add your preferred colour letter to codes

Glass (mm)	Enclosure Size (mm)	Handing	Adjustment (mm)	Aperture (mm)	Door Code	In-Line Panel Code	Total Cost ex VAT	Total Cost inc VAT
8	1200	Left Hand	1173 - 1187	640	KL1HDFL	KL1H12FL	£2136.41	£2563.69
8	1200	Right Hand	1173 - 1187	640	KL1HDFR	KL1H12FR	£2136.41	£2563.69
8	1400	Left Hand	1373 - 1387	640	KL1HDFL	KL1H14FL	£2318.15	£2781.78
8	1400	Right Hand	1373 - 1387	640	KL1HDFR	KL1H14FR	£2318.15	£2781.78
8	1600	Left Hand	1573 - 1587	640	KL1HDFL	KL1H16FL	£2496.45	£2995.74
8	1600	Right Hand	1573 - 1587	640	KL1HDFR	KL1H16FR	£2496.45	£2995.74

Compatible Trays	Page
Roman Anti-Slip Trays	88 - 89
Roman Infinity Trays	90 - 91
Roman Low Level Trays	94 - 95

Liberty

Black Grid Hinged Door

With In-line Panel



1200 Alcove Fitting (Left Hand)

1200 Door and In-Line Panel:
TL1HDBGBL & TL1H12BGBL

1200 x 800 Anti-Slip Tray: RST128

Black Shower Basket: RSB07B

Arched Black Grid Mirror: MIRO2

Inward or Outward Opening

“Industrial chic”

Features and Benefits



Matt Black Aluminium Hardware

Printed Black Grid design

Door is hinged from wall

New minimal easy fix wall profile system

Adjustable hinges for Inward or Outward opening door

Door is hinged from wall

Integrated 'tray or floor' Water Safe System

Designed for installation to straight vertical walls

Optional brace bar included

Left or Right handing must be specified when ordering

Compatible trays available



1200 x 800 Corner Fitting (left hand)

1200 x 800 Door, In-Line Panel and Side Panel:
TL1HDRBGBL, TL1HR12BGBL & THR8BGBL

1200 x 800 Anti-Slip Tray: RST128

Black Shower Basket: RSB07B

Square Black Grid Mirror: MIR01

Alcove Fitting

Left or Right handing must be specified when ordering

Enclosure Size (mm)	Handing	Adjustment (mm)	Aperture (mm)	Door Code	In-Line Panel Code	Total Cost ex VAT	Total Cost inc VAT
760	Left hand	733 - 747	500	TL1HD2BGBL	TL1H76BGBL	£1435.57	£1722.68
760	Right hand	733 - 747	500	TL1HD2BGBR	TL1H76BGBR	£1435.57	£1722.68
800	Left hand	773 - 787	500	TL1HD2BGBL	TL1H8BGBL	£1507.82	£1809.38
800	Right hand	773 - 787	500	TL1HD2BGBR	TL1H8BGBR	£1507.82	£1809.38
900	Left hand	873 - 887	640	TL1HDBGBL	TL1H9BGBL	£1580.07	£1896.08
900	Right hand	873 - 887	640	TL1HDBGBR	TL1H9BGBR	£1580.07	£1896.08
1200	Left hand	1173 - 1187	640	TL1HDBGBL	TL1H12BGBL	£1809.40	£2171.28
1200	Right hand	1173 - 1187	640	TL1HDBGBR	TL1H12BGBR	£1809.40	£2171.28

Please note:

Sizes 760, 800, 900, 1000 the Inline Panel consists of one row of grid.
1200, 1400 sizes have an Inline Panel of 2 rows. 1600 size has an Inline Panel of 3 rows



Left Hand

Right Hand

Corner Fitting

Left or Right handing must be specified when ordering

Enclosure Size (mm)	Handing	Adjustment (mm)	Aperture (mm)	Door Code	In-Line Panel Code	Side Panel Code	Total Cost ex VAT	Total Cost inc VAT
1000 x 800	Left hand	773 - 787	667	TL1HDRBGBL	TL1HR10BGBL	THR8BGBL	£2186.40	£2623.68
1000 x 800	Right hand	773 - 787	667	TL1HDRBGBR	TL1HR10BGBR	THR8BGBR	£2186.40	£2623.68
1000 x 900	Left hand	873 - 887	667	TL1HDRBGBL	TL1HR10BGBL	THR9BGBL	£2261.79	£2714.15
1000 x 900	Right hand	873 - 887	667	TL1HDRBGBR	TL1HR10BGBR	THR9BGBR	£2261.79	£2714.15
1200 x 800	Left hand	773 - 787	667	TL1HDRBGBL	TL1HR12BGBL	THR8BGBL	£2412.56	£2895.07
1200 x 800	Right hand	773 - 787	667	TL1HDRBGBR	TL1HR12BGBR	THR8BGBR	£2412.56	£2895.07
1200 x 900	Left hand	873 - 887	667	TL1HDRBGBL	TL1HR12BGBL	THR9BGBL	£2487.95	£2985.54
1200 x 900	Right hand	873 - 887	667	TL1HDRBGBR	TL1HR12BGBR	THR9BGBR	£2487.95	£2985.54
1400 x 800	Left hand	773 - 787	667	TL1HDRBGBL	TL1HR14BGBL	THR8BGBL	£2487.96	£2985.55
1400 x 800	Right hand	773 - 787	667	TL1HDRBGBR	TL1HR14BGBR	THR8BGBR	£2487.96	£2985.55
1400 x 900	Left hand	873 - 887	667	TL1HDRBGBL	TL1HR14BGBL	THR9BGBL	£2563.35	£3076.02
1400 x 900	Right hand	873 - 887	667	TL1HDRBGBR	TL1HR14BGBR	THR9BGBR	£2563.35	£3076.02
1600 x 800	Left hand	773 - 787	667	TL1HDRBGBL	TL1HR16BGBL	THR8BGBL	£2714.13	£3256.96
1600 x 800	Right hand	773 - 787	667	TL1HDRBGBR	TL1HR16BGBR	THR8BGBR	£2714.13	£3256.96
1600 x 900	Left hand	873 - 887	667	TL1HDRBGBL	TL1HR16BGBL	THR9BGBL	£2789.52	£3347.42
1600 x 900	Right hand	873 - 887	667	TL1HDRBGBR	TL1HR16BGBR	THR9BGBR	£2789.52	£3347.42

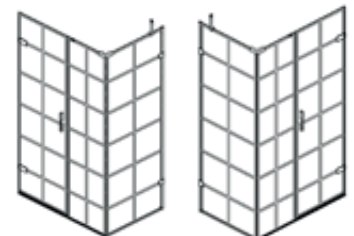

Left Hand

Right Hand

Compatible Trays	Page
Roman Anti-Slip Trays	88 - 89
Roman Infinity Trays	90 - 91
Roman Low Level Trays	94 - 95

Liberty

Hinged Door

With Two In-line Panels



1600 Alcove Fitting with
Brushed Brass finish

8mm Door and In-Line Panel:
KLHD13BR and KLH1613BR

1600 x 800 Gloss Infinity Tray: IAG168

Inward or Outward Opening

“Cleverly use the alcove space in your bathroom with the frameless hinged door with two in-line panels”

Features and Benefits



Hinged from In-Line Panel

New clear and minimal seals

New minimal easy fix wall profile system

Adjustable hinges for Inward or Outward opening door

Choice of colour finishes available

Integrated 'tray or floor' Water Safe System

Designed for installation to straight vertical walls

Optional brace bars included

Compatible trays available



1600 Alcove Fitting with Matt Black finish

8mm Door and In-Line Panel: KLHD13B and KLH1613B

1600 x 800 Gloss Infinity Tray: IAG168

Shower Basket: RSB05B

Colour options for hardware:



Matt Black
add **B**
to codes

Chrome
add **S**
to codes

Brushed Nickel
add **N**
to codes

Polished Nickel
add **PN**
to codes

Brushed Brass
add **BR**
to codes

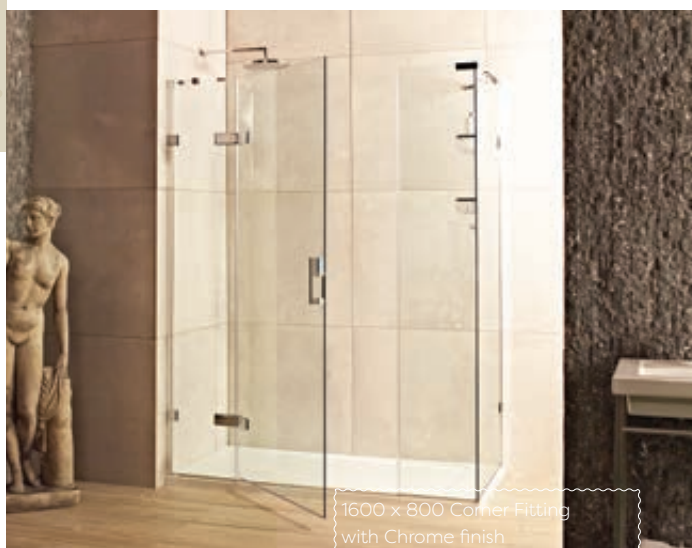

1600 x 800 Corner Fitting with Chrome finish

8mm Door, In-Line Panel and Side Panel: KLHDR13S, KLHR1613S and KHR813S

1600 x 800 Gloss Infinity Tray: IAG168

Shower Basket: RSB01

Alcove Fitting Add your preferred colour letter to codes

Glass (mm)	Enclosure Size (mm)	Adjustment (mm)	Aperture (mm)	Door Code	In-Line Panel Code	Total Cost ex VAT	Total Cost inc VAT
8	1200	1166 - 1194	653	KLHD13	KLH1213	£1499.42	£1799.30
8	1400	1366 - 1394	653	KLHD13	KLH1413	£1624.40	£1949.28
8	1600	1566 - 1594	653	KLHD13	KLH1613	£1749.34	£2099.21
10	1200	1166 - 1194	653	TLHD13	TLH1213	£1675.84	£2011.01
10	1400	1366 - 1394	653	TLHD13	TLH1413	£1815.50	£2178.60
10	1600	1566 - 1594	653	TLHD13	TLH1613	£1955.15	£2346.18

Compatible Trays	Page
Roman Anti-Slip Trays	88 - 89
Roman Infinity Trays	90 - 91
Roman Low Level Trays	94 - 95

Corner Fitting Add your preferred colour letter to codes

Glass (mm)	Enclosure Size (mm)	Adjustment (mm) Door and In-Line Panel	Adjustment (mm) Side Panel	Aperture (mm)	Door Code	In-Line Panel Code	Side Panel Code	Total Cost ex VAT	Total Cost inc VAT
8	1200 x 800	1173 - 1187	773 - 787	653	KLHDR13	KLHR1213	KHR813	£2073.68	£2488.42
8	1200 x 900	1173 - 1187	873 - 887	653	KLHDR13	KLHR1213	KHR913	£2135.80	£2562.96
8	1400 x 800	1373 - 1387	773 - 787	653	KLHDR13	KLHR1413	KHR813	£2139.88	£2567.86
8	1400 x 900	1373 - 1387	873 - 887	653	KLHDR13	KLHR1413	KHR913	£2202.00	£2642.40
8	1600 x 800	1573 - 1587	773 - 787	653	KLHDR13	KLHR1613	KHR813	£2338.32	£2805.98
8	1600 x 900	1573 - 1587	873 - 887	653	KLHDR13	KLHR1613	KHR913	£2400.44	£2880.53
10	1200 x 800	1173 - 1187	773 - 787	653	TLHDR13	TLHR1213	THR813	£2188.92	£2626.70
10	1200 x 900	1173 - 1187	873 - 887	653	TLHDR13	TLHR1213	THR913	£2254.47	£2705.36
10	1400 x 800	1373 - 1387	773 - 787	653	TLHDR13	TLHR1413	THR813	£2258.78	£2710.54
10	1400 x 900	1373 - 1387	873 - 887	653	TLHDR13	TLHR1413	THR913	£2324.33	£2789.20
10	1600 x 800	1573 - 1587	773 - 787	653	TLHDR13	TLHR1613	THR813	£2468.25	£2961.90
10	1600 x 900	1573 - 1587	873 - 887	653	TLHDR13	TLHR1613	THR913	£2533.80	£3040.56

*In-Line Panel Code is pack of 2 panels

Liberty

Hinged Door

With Hinged In-line Panel



1200 x 900 Corner Fitting
with Matt Black finish

8mm Door, In-Line Panel and Side Panel:
KL2HDR13B, KL2HR1213B and K1R913B

1200 x 900 Gloss White Infinity Tray:
IAG129

Shower Basket: RSB03

Outward Opening

“ Keep your bathroom at the forefront of fashion
with the luxuriously minimalist Liberty Collection ”

Features and Benefits



- Hinged from In-Line Panel
- New clear and minimal seals
- New minimal easy fix wall profile system
- Choice of colour finishes available
- Integrated 'tray or floor' Water Safe System
- Designed for installation to straight vertical walls
- Optional brace bar included
- Compatible trays available



1200 Alcove Fitting with Chrome finish
 8mm Door and In-Line Panel: KL2HD13S and KL2H1213S
 1200 x 900 Gloss White Infinity Tray: IAG129
 Shower Basket: RSB03

Matt Black finish



Colour options for hardware:



Matt Black add B to codes
Chrome add S to codes
Brushed Nickel add N to codes
Polished Nickel add PN to codes
Brushed Brass add BR to codes

Alcove Fitting - inward or outward opening Add your preferred colour letter to codes

Glass (mm)	Enclosure Size (mm)	Adjustment (mm)	Aperture (mm)	Door Code	In-Line Panel Code	Total Cost ex VAT	Total Cost inc VAT
8	1000	973 - 987	760	KL2HD13	KL2H1013	£1382.06	£1685.47
8	1200	1173 - 1187	760	KL2HD13	KL2H1213	£1499.42	£1799.30
10	1000	973 - 987	760	TL2HD13	TL2H1013	£1536.18	£1843.42
10	1200	1173 - 1187	760	TL2HD13	TL2H1213	£1675.84	£2011.01

Compatible Trays	Page
Roman Anti-Slip Trays	88 - 89
Roman Infinity Trays	90 - 91
Roman Low Level Trays	94 - 95

Corner Fitting - outward opening only Add your preferred colour letter to codes

Glass (mm)	Enclosure Size (mm)	Adjustment (mm) Door and In-Line Panel	Adjustment (mm) Side Panel	Aperture (mm)	Door Code	In-Line Panel Code	Side Panel Code	Total Cost ex VAT	Total Cost inc VAT
8	1000 x 760	973 - 987	733 - 747	760	KL2HDR13	KL2HR1013	K1R7613	£1813.84	£2176.61
8	1000 x 800	973 - 987	773 - 787	760	KL2HDR13	KL2HR1013	K1R813	£1875.96	£2251.15
8	1000 x 900	973 - 987	873 - 887	760	KL2HDR13	KL2HR1013	K1R913	£1938.05	£2325.66
8	1000 x 1000	973 - 987	973 - 987	760	KL2HDR13	KL2HR1013	K1R1013	£2062.29	£2474.75
8	1200 x 760	1173 - 1187	733 - 747	760	KL2HDR13	KL2HR1213	K1R7613	£2012.29	£2414.75
8	1200 x 800	1173 - 1187	773 - 787	760	KL2HDR13	KL2HR1213	K1R813	£2074.41	£2489.29
8	1200 x 900	1173 - 1187	873 - 887	760	KL2HDR13	KL2HR1213	K1R913	£2136.50	£2563.80
8	1200 x 1000	1173 - 1187	973 - 987	760	KL2HDR13	KL2HR1213	K1R1013	£2260.74	£2712.89
10	1000 x 760	973 - 987	733 - 747	760	TL2HDR13	TL2HR1013	T1R7613	£1914.59	£2297.51
10	1000 x 800	973 - 987	773 - 787	760	TL2HDR13	TL2HR1013	T1R813	£1980.16	£2376.19
10	1000 x 900	973 - 987	873 - 887	760	TL2HDR13	TL2HR1013	T1R913	£2045.72	£2454.86
10	1000 x 1000	973 - 987	973 - 987	760	TL2HDR13	TL2HR1013	T1R1013	£2176.85	£2612.22
10	1200 x 760	1173 - 1187	733 - 747	760	TL2HDR13	TL2HR1213	T1R7613	£2124.07	£2548.88
10	1200 x 800	1173 - 1187	773 - 787	760	TL2HDR13	TL2HR1213	T1R813	£2189.64	£2627.57
10	1200 x 900	1173 - 1187	873 - 887	760	TL2HDR13	TL2HR1213	T1R913	£2255.20	£2706.24
10	1200 x 1000	1173 - 1187	973 - 987	760	TL2HDR13	TL2HR1213	T1R1013	£2386.33	£2863.60

Neo Angle Enclosure



1200 x 900 Neo Angle

Neo-Angle Door: DXPD8

Neo-Angle Panels: DXPI29PAL

Neo-Angle Shower Tray: DNT129L

Shower Basket: RSB01

Outward Opening

“ Ingenious angled design fits around existing fixtures and fittings ”

Features and Benefits

GLASS THICKNESS 10 Millimetres	TOTAL HEIGHT 2008 Millimetres	GLASS PROTECTION ULTRA CARE BY BEMAN	TRUELIFE LIFETIME GUARANTEE
--	---	--	--

- Wall profile height 2000mm
- Total height to top of bracing 2008mm
- Chromed brass machined components
- Chromed brass self-closing hinges and feature handle
- Low profile PVC seals
- Bright silver frame
- 15mm of adjustment in each profile
- Integrated 'tray or floor' Water Safe System
- Please indicate handing (RH or LH) when ordering
- Door always hinges from the short panel
- Compatible trays available



900 x 900 Neo Angle
 Neo-Angle Door: DXPDB
 Neo-Angle Panels: DXP9PAL
 Neo-Angle Shower Tray: DNT9
 Shower Basket: RSB02



Square Hardware



Please note: Door aperture/projection is 660mm - enclosure size required is achieved by size of Neo Panels (this is reflected in Order Codes).

Corner Fitting

Left or Right handing must be specified when ordering

Enclosure Size (mm)	Handing	Adjustment (mm)	Door Code (mm)	Neo-Panels Code	Total Cost ex VAT	Total Cost inc VAT
900 x 900	Left Hand	860 - 875	DXPDB	DXP9PAL	£1774.49	£2129.39
900 x 900	Right Hand	860 - 875	DXPDB	DXP9PAR	£1774.49	£2129.39
1200 x 900	Left Hand	1160 - 1175 & 860 - 875	DXPDB	DXP129PAL	£1971.65	£2365.98
1200 x 900	Right Hand	1160 - 1175 & 860 - 875	DXPDB	DXP129PAR	£1971.65	£2365.98

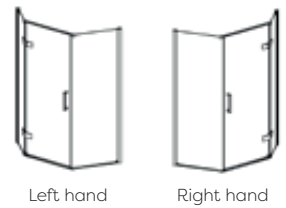

Left hand

Right hand

Neo-Angle Trays:

See page 92 for full details and pricing

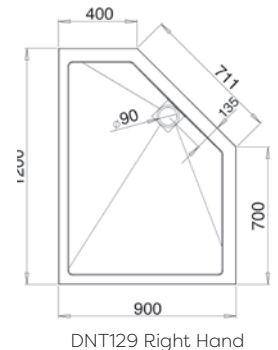
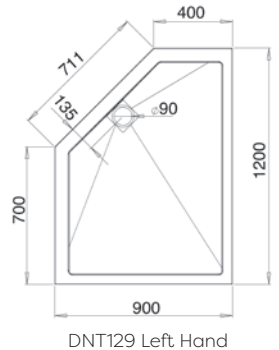
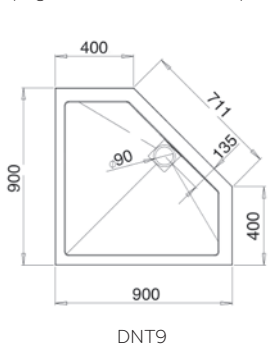



“ Design is not just what it looks like and feels like. Design is how it works. ”

- Steve Jobs

8mm

Innov8

Curved Quadrants*

Sliding Doors*

Hinged Doors

Pivot Doors

Bi-Fold Doors

Wetroom Panels

* Fast Fix assembly now included on all sliding door enclosures

Frameless Collection

A distinctive collection, encompassing both minimalist frameless and industrial style framed Shower Enclosures.

The Innov8 Range encapsulates industrial chic with an elegant twist.

Innov8 Enclosures lead the way in minimal, inclusive and stylish design trends - presenting a refined collection.

The distinguished range is available in Silver Chrome, Matt Black and Brushed Brass finish, on all hardware.

Innov8's outstanding differential is the low threshold (reduced height of bottom rail), allowing level entry access into the shower enclosure. The elimination of the top rail and profiles on the hinged doors (when configured with a side or in-line panel) and the low threshold, combines the minimalist styling, whilst still retaining the water integrity and adjustments of a standard shower enclosure.

The minimalist nature of the product means if the shower head is directed at seal and component interfaces, some water may escape from the showering area. The product will perform as intended under normal showering conditions.

The new fast fix assembly allows a quick and easy installation with minimal labour required.



Sliding Door



Closed

1500 x 800 Corner Fitting
Sliding Door and Side Panel with
Brushed Brass finish: N2T1513BBR and
N2GL813BBR
1500 x 800 White Anti Slip Tray: RST158
Shower Basket: RSB03



1500 x 800 Corner Fitting
Sliding Door and Side Panel with
Chrome finish: N2T1513S and N2GL813S
1500 x 800 White Anti Slip Tray: RST158
Shower Basket: RSB03

Features and Benefits



-
- Glass Height 1950mm
-
- Choice of colour finish
-
- Chromed brass machined components
-
- Chromed brass feature handle
-
- Low profile PVC seals
-
- 20mm of adjustment in each profile
-
- Fast Fix Assembly
-
- Sliding Door
-
- Compatible trays available
-



Closed

1700 x 800 Alcove Fitting
 Sliding Door: N2T1713B
 1700 x 800 Matt Grey Anti Slip
 Tray: RST178MG
 Shower Basket: RSB05B

Colour options for hardware:



Please Note:
 Brushed Brass finish
 availability Autumn 2022



Open

Alcove Fitting Add your preferred colour letter to codes

Enclosure Size (mm)	Adjustment (mm)	Door Aperture (mm)	Door Code	Cost ex VAT	Cost inc VAT
1200	1150 - 1190	470	N2T1213	£929.33	£1115.20
1400	1350 - 1390	570	N2T1413	£958.26	£1149.91
1500	1450 - 1490	620	N2T1513	£967.24	£1160.69
1700	1650 - 1690	720	N2T1713	£986.53	£1183.84

Corner Fitting Add your preferred colour letter to codes

Enclosure Size (mm)	Adjustment (mm) Door	Adjustment (mm) Side Panel	Door Aperture (mm)	Door Code	Side Panel Code	Total Cost ex VAT	Total Cost inc VAT
1200 x 800	1170 - 1210	755 - 775	470	N2T1213	N2GL813	£1361.25	£1633.50
1200 x 900	1170 - 1210	855 - 875	470	N2T1213	N2GL913	£1396.85	£1676.22
1400 x 800	1370 - 1410	755 - 775	570	N2T1413	N2GL813	£1390.18	£1668.22
1400 x 900	1370 - 1410	855 - 875	570	N2T1413	N2GL913	£1425.78	£1710.94
1500 x 800	1470 - 1510	755 - 775	620	N2T1513	N2GL813	£1399.16	£1687.99
1500 x 900	1470 - 1510	855 - 875	620	N2T1513	N2GL913	£1434.76	£1721.71
1700 x 800	1670 - 1710	755 - 775	720	N2T1713	N2GL813	£1418.45	£1702.14
1700 x 900	1670 - 1710	855 - 875	720	N2T1713	N2GL913	£1454.05	£1744.86

Description	Colour	Height (mm)	Adds Extra (mm)	Code	Cost ex VAT	Cost inc VAT
Extension Profile	Silver	1950	35	VZEX2S	£86.75	£104.10
Extension Profile	Black	1950	35	VZEX2B	£86.75	£104.10

Compatible Trays	Page
Roman Anti-Slip Trays	88 - 89
Roman Infinity Trays	90 - 91
Roman Low Level Trays	94 - 95

Curved Quadrant



Closed

900 x 1200 Quadrant
with Matt Black finish

Quadrant with Matt Black
finish: N2SQ91213B

Roman Low Level Tray: RLQ129

Shower Basket: RSB02B

Sliding Opening



Open

Features and Benefits

GLASS THICKNESS
8
Millimetres

TOTAL HEIGHT
1950
Millimetres

REVERSIBLE

GLASS PROTECTION
ULTRA CARE
BY ROMAN

TRULIFE
LIFETIME GUARANTEE

Glass Height 1950mm

Bright Silver or Black frame

Chromed brass machined components

Chromed brass feature handle

Low profile PVC seals

20mm of adjustment in each profile

Fast Fix Assembly

Sliding Door

Compatible trays available



900 x 900 Quadrant
with Chrome finish

Quadrant with Chrome finish:
N2SQ913S

Roman Infinity Tray: IA9Q

Shower Basket: RSB02S



Colour options for hardware:



Chrome
add **S**
to codes



Matt Black
add **B**
to codes

Add your preferred colour letter to codes

Enclosure Size (mm)	Description	Adjustment (mm)	Door Aperture (mm)	Code	Cost ex VAT	Cost inc VAT
900 x 900	Quadrant	855 - 875	430	N2SQ913	£1164.22	£1397.06
800 x 900	Quadrant	755 - 775 & 855 - 875	430	N2SQ8913	£1164.22	£1397.06
800 x 1000	Quadrant	755 - 775 & 955 - 975	430	N2SQ81013	£1352.17	£1622.60
800 x 1200	Quadrant	755 - 775 & 1155 - 1175	430	N2SQ81213	£1410.02	£1692.02
900 x 1200	Quadrant	855 - 875 & 1155 - 1175	430	N2SQ91213	£1467.85	£1761.42

Compatible Trays	Page
Roman Infinity Trays	90 - 91
Roman Low Level Trays	94 - 95

Innov8

Hinged Door

With In-line Panel



Closed

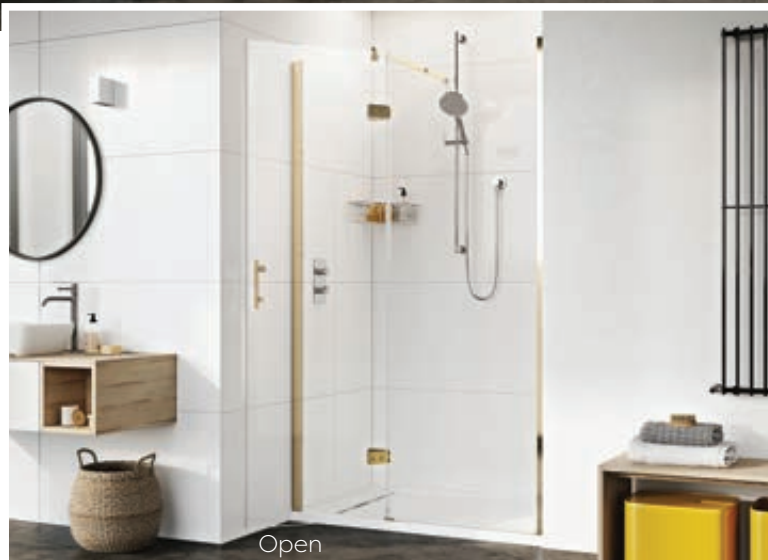

Open

1200 Alcove Fitting
Hinged Door and In-Line Panel:
NL2HD13BBR and NL2H1213BBR
Roman Infinity Tray: IAG128
Shower Basket: RSB04

Outward Opening

Features and Benefits



- Glass Height 1950mm
- Choice of colour finish
- Chromed brass machined components
- Chromed brass feature handle
- Low profile PVC seals
- 20mm of adjustment in each profile
- No top rail
- Side Panels supplied with optional bracing
- Outward opening only
- Compatible trays available



1000 x 800 Corner Fitting

- Hinged Door: NL2HDR13B
- In-Line Panel: NL2HR1013B
- Side Panel: N2R813B
- Shower Basket: RSB02B



1200 Alcove Fitting

- Hinged Door and In-Line Panel: NL2HD13S and NL2HI1213S
- Roman Infinity Tray: IAG128
- Shower Basket: RSB04

Colour options for hardware:



Chrome
add S
to codes

Matt Black
add B
to codes

Brushed Brass
add BBR
to codes

Please Note:
Brushed Brass finish
availability Autumn 2022

Corner Fitting Add your preferred colour letter to codes

Enclosure Size (mm)	Adjustment (mm) Door and In-Line Panel	Adjustment (mm) Side Panel	Door Aperture (mm)	Door Code	In-Line Panel Code	Side Panel Code	Total Cost ex VAT	Total Cost inc VAT
1000 x 800	955 - 975	755 - 775	610	NL2HDR13	NL2HR1013	N2R813	£1522.48	£1826.98
1000 x 900	955 - 975	855 - 875	610	NL2HDR13	NL2HR1013	N2R913	£1558.08	£1869.70
1200 x 800	1155 - 1175	755 - 775	610	NL2HDR13	NL2HR1213	N2R813	£1584.95	£1901.94
1200 x 900	1155 - 1175	855 - 875	610	NL2HDR13	NL2HR1213	N2R913	£1620.55	£1944.66

Alcove Fitting Add your preferred colour letter to codes

Enclosure Size (mm)	Adjustment (mm)	Door Aperture (mm)	Door Code	In-Line Panel Code	Total Cost ex VAT	Total Cost inc VAT
1000	950 - 990	610	NL2HD13	NL2HI1013	£1090.56	£1308.67
1200	1150 - 1190	610	NL2HD13	NL2HI1213	£1153.03	£1383.64

Compatible Trays	Page
Roman Anti-Slip Trays	88 - 89
Roman Infinity Trays	90 - 91
Roman Low Level Trays	94 - 95

Innov8

Hinged Door

with two in-line panels



1200 Alcove Fitting

Hinged Door: NLHD13B

In-Line Panel: NLH1213B

Shower Basket: RSB05B

features and benefits



- ~~~~~
- Glass Height 1950mm
- ~~~~~
- Choice of colour finish
- ~~~~~
- Chromed brass machined components
- ~~~~~
- Chromed brass feature handle
- ~~~~~
- Low profile PVC seals
- ~~~~~
- 20mm of adjustment in each profile
- ~~~~~
- No top rail
- ~~~~~
- Side Panels supplied with optional bracing
- ~~~~~
- Outward opening only
- ~~~~~
- Compatible trays available
- ~~~~~

Lead-time 10-14 days



1600 x 800 Corner Fitting

Hinged Door: NLHDR13BBR

In-Line Panel: NLHR1613BBR

Side Panel: N3R813BBR



1200 Alcove Fitting

Hinged Door: NLHD13S

In-Line Panel: NLH1213S

Shower Basket: RSB05

Colour options for hardware:



Please Note:
Brushed Brass finish
availability Autumn 2022

Corner Fitting Add your preferred colour letter to codes

Enclosure Size (mm)	Adjustment (mm) Door and In-Line Panel	Adjustment (mm) Side Panel	Door Aperture (mm)	Door Code	In-Line Panel Code*	Side Panel Code	Total Cost ex VAT	Total Cost inc VAT
1200 x 800	1155 - 1175	755 - 775	630	NLHDR13	NLHR1213	N3R813	£1711.92	£2054.31
1200 x 900	1155 - 1175	855 - 875	630	NLHDR13	NLHR1213	N3R913	£1747.52	£2097.03
1400 x 800	1355 - 1375	755 - 775	630	NLHDR13	NLHR1413	N3R813	£1771.92	£2126.31
1400 x 900	1355 - 1375	855 - 875	630	NLHDR13	NLHR1413	N3R913	£1807.52	£2169.03
1600 x 800	1555 - 1575	755 - 775	630	NLHDR13	NLHR1613	N3R813	£1831.92	£2198.31
1600 x 900	1555 - 1575	855 - 775	630	NLHDR13	NLHR1613	N3R913	£1867.52	£2241.03

Alcove Fitting Add your preferred colour letter to codes

Enclosure Size (mm)	Adjustment (mm)	Door Aperture (mm)	Door Code	In-Line Panel Code	Total Cost ex VAT	Total Cost inc VAT
1200	1150 - 1190	630	NLHD13	NLH1213	£1280.00	£1536.00
1400	1350 - 1390	630	NLHD13	NLH1413	£1340.00	£1608.00
1600	1550 - 1590	630	NLHD13	NLH1613	£1400.00	£1680.00

Based on perception only - on the 1600mm corner units it may be necessary to install the bracing bar on the in-line panel (door closing side) back to wall to minimise panel movement.

Compatible Trays	Page
Roman Anti-Slip Trays	88 - 89
Roman Infinity Trays	90 - 91
Roman Low Level Trays	94 - 95

Pivot Door



900 x 900 Corner Fitting
Pivot Door: N2F913CS
Side Panel: N2R913S
Roman Low Level Tray: RLT9
Shower Basket: RSB07

Outward Opening

“ A minimalist design with its frameless look presenting inclusivity for all users with its low threshold ”

Features and Benefits



Glass Height 1950mm

Height to top of pivot tube 1967mm

Bright Silver or Black frame

Chromed brass machined components

Chromed brass feature handle

Low profile PVC seals

20mm of adjustment in each profile

No top rail

Full length pivoting tube

Side Panels supplied with optional bracing

Outward opening only

Compatible trays available



900 Alcove Fitting

Pivot Door: N2F913S

Roman Low Level Tray: RLT90

Shower Basket: RSB07

Black Grid Mirror: MIR02



Alcove Fitting

Add your preferred colour letter to codes

Enclosure Size (mm)	Description	Adjustment (mm)	Door Aperture (mm)	Door Code	Cost ex VAT	Cost inc VAT
760	Door	710 - 750	600	N2F7613	£667.41	£800.89
800	Door	750 - 790	640	N2F813	£667.41	£800.89
900	Door	850 - 890	740	N2F913	£719.43	£863.32

Corner Fitting

Add your preferred colour letter to codes

Enclosure Size (mm)	Description	Adjustment (mm)	Aperture (mm)	Door Code	Cost ex VAT	Cost inc VAT
760	Door	715 - 735	630	N2F7613C	£667.41	£800.89
800	Door	755 - 775	670	N2F813C	£667.41	£800.89
900	Door	855 - 875	770	N2F913C	£719.43	£863.32
760	Side Panel	715 - 735	-	N2R7613	£431.92	£518.30
800	Side Panel	755 - 775	-	N2R813	£431.92	£518.30
900	Side Panel	855 - 875	-	N2R913	£467.52	£561.02

Colour options for hardware:



Chrome
add S
to codes



Matt Black
add B
to codes

Compatible Trays	Page
Roman Anti-Slip Trays	88 - 89
Roman Infinity Trays	90 - 91
Roman Low Level Trays	94 - 95

Innov8

Pivot Door

With In-line Panel



1200 x 900 Corner Fitting

1200 Door, In-Line Panel and Side Panel:
N2F1HDR13B, N2HR1213B and N2HR913B

1200 x 900 Anti-Slip Tray: RST129

Shower Basket: RSB02

Arched Black Grid Mirror: M1R02

Inward or Outward Opening

“ This frameless Pivot Door introduces a distinctive minimalist look, inclusive design and supreme functionality ”

Features and Benefits



Glass Height 1950mm

Height to top of pivot tube 1967mm

Bright Silver or Black frame

Chromed brass machined components

Chromed brass feature handle

Low profile PVC seals

20mm of adjustment in each profile

No top rail

Can be installed for inward or outward opening

Full length pivoting tube

In-Line Panels supplied with optional bracing

Rubber handle stopper included for inward opening doors

Compatible trays available



1200 Alcove Fitting

Pivot Door and Inline Panel:
N2F1HD13S and N2H1213S

Anti Slip Tray: RST129

Shower Basket: RSB02



Optional rubber stopper



Colour options for hardware:



Chrome
add **S**
to codes



Matt Black
add **B**
to codes

Corner Fitting Add your preferred colour letter to codes

Enclosure Size (mm)	Adjustment (mm) Door and In-Line Panel	Adjustment (mm) Side Panel	Door Aperture (mm)	Door Code	In-Line Panel Code	Side Panel Code	Total Cost ex VAT	Total Cost inc VAT
1000 x 800	955 - 975	755 - 775	585	N2F1HDR13	N2HR1013	N2HR813	£1423.34	£1708.01
1000 x 900	955 - 975	855 - 875	585	N2F1HDR13	N2HR1013	N2HR913	£1458.94	£1750.73
1200 x 800	1155 - 1175	755 - 775	585	N2F1HDR13	N2HR1213	N2HR813	£1480.12	£1776.14
1200 x 900	1155 - 1175	855 - 875	585	N2F1HDR13	N2HR1213	N2HR913	£1515.72	£1818.86
1400 x 800	1355 - 1375	755 - 775	640	N2F2HDR13	N2HR1413	N2HR813	£1537.97	£1845.56
1400 x 900	1355 - 1375	855 - 875	640	N2F2HDR13	N2HR1413	N2HR913	£1573.57	£1888.28
1500 x 800	1455 - 1475	755 - 775	640	N2F2HDR13	N2HR1513	N2HR813	£1595.80	£1914.96
1500 x 900	1455 - 1475	855 - 875	640	N2F2HDR13	N2HR1513	N2HR913	£1631.40	£1957.68

Alcove Fitting Add your preferred colour letter to codes

Enclosure Size (mm)	Adjustment (mm)	Door Aperture (mm)	Door Code	In-Line Panel Code	Total Cost ex VAT	Total Cost inc VAT
1000	950 - 990	585	N2F1HD13	N2H1013	£991.42	£1189.70
1200	1150 - 1190	585	N2F1HD13	N2H1213	£1048.20	£1257.84
1400	1350 - 1390	640	N2F2HD13	N2H1413	£1106.05	£1327.26
1500	1450 - 1490	640	N2F2HD13	N2H1513	£1163.88	£1396.66

Compatible Trays	Page
Roman Anti-Slip Trays	88 - 89
Roman Infinity Trays	90 - 91
Roman Low Level Trays	94 - 95

Innov8

Bi-Fold Door

Frameless



900 x 900 Corner Fitting
Bi-Fold Door: N2V913CS
Side Panel: N2R913S
Roman Tray: RLT90

Inward Opening

“ Roman has once again innovated to remove top and bottom framing ”

Features and Benefits



Frameless inward opening doors with 180° pivoting action

Bright Silver or Black frame

Chromed brass hinges

Chromed top caps

Clear seals

No top rail

Elimination of the bottom rail creating level access entry

Compatible trays available



900 Alcove fitting

Bi-Fold Door: N2V913B

Roman Tray: RLT90

Shower Basket: RSB050

Alcove Fitting Add your preferred colour letter to codes

Enclosure Size (mm)	Description	Adjustment (mm)	Door Aperture (mm)	Door Code	Cost ex VAT	Cost inc VAT
760	Bi-Fold Door	710 - 750	590	N2V7613	£818.16	£981.79
800	Bi-Fold Door	750 - 790	630	N2V813	£818.16	£981.79
900	Bi-Fold Door	850 - 890	730	N2V913	£879.02	£1054.82
1000	Bi-Fold Door	950 - 990	830	N2V1013	£939.89	£1127.87

Colour options for hardware:



Chrome
add **S**
to codes



Matt Black
add **B**
to codes

Corner Fitting Add your preferred colour letter to codes

Enclosure Size (mm)	Description	Adjustment (mm)	Aperture (mm)	Door Code	Cost ex VAT	Cost inc VAT
760	Bi-Fold Door	715 - 735	620	N2V7613C	£818.16	£981.79
800	Bi-Fold Door	755 - 775	660	N2V813C	£818.16	£981.79
900	Bi-Fold Door	855 - 875	760	N2V913C	£879.02	£1054.82
1000	Bi-Fold Door	955 - 975	860	N2V1013C	£939.89	£1127.87
760	Side Panel*	715 - 735	-	N2R7613	£431.92	£518.30
800	Side Panel*	755 - 775	-	N2R813	£431.92	£518.30
900	Side Panel*	855 - 875	-	N2R913	£467.52	£561.02
1000	Side Panel*	955 - 975	-	N2R1013	£507.13	£608.56

* Side Panel supplied with optional brace bar

Compatible Trays	Page
Roman Anti-Slip Trays	88 - 89
Roman Infinity Trays	90 - 91
Roman Low Level Trays	94 - 95

“ I strive for two things in design: simplicity and clarity.
Great design is born of those two things. ”

- Lindon Leader

6mm

&
8mm

Embrace

Curved Quadrants*

Hinged Doors

Sliding Doors

Pivot Doors

Bi-Fold Doors

Wetroom Panels

* Fast Fix assembly now included
on all sliding door enclosures

Semi-Frameless Collection

Imaginative, urbane and innovative showering solutions designed to maximise space.

Our Embrace Collection brings together an innovative and stylish collection of shower enclosures and wetroom panels offering high performance and design benefits at an extremely competitive price. This exclusive range is available in an array of styles and shapes with bi-fold, hinged, quadrant, pivot, sliding doors and bath screens.

Specifications:

- All models feature exquisite chromed hardware and concealed fittings.
- All enclosures in the range are fully approved for use with power showers.
- Models that feature handle entry, present an elegant ergonomic bolt through handle which can be operated from inside and outside the unit.
- All Embrace enclosures and bath screens are supplied pre-coated with Roman Ultra Care - to aid glass protection from day one.

The new fast fix assembly allows a quick and easy installation with minimal labour required.

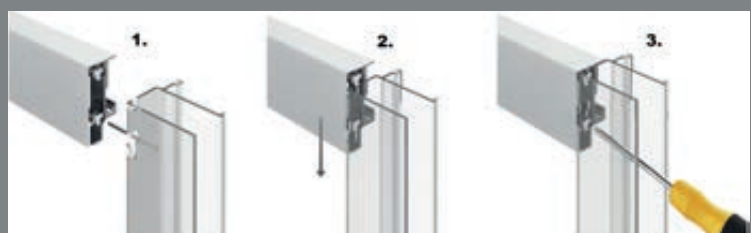

Embrace

One Door Quadrant

Features and Benefits



Silver frame

Fast Fix System

Vertical adjustment: 25mm

Smooth running roller bearing

'Quick release' system for easy cleaning

Tray compatibility: 550mm radius



1200 x 900 One Door Quadrant.

One Door Quadrant: ESQ91213S

Offset Roman Low Level Tray (right hand):
RLQ129R

“ A fusion of elegant styling
and practical functionality ”

Size (mm)	Description	Adjustment (mm)	Aperture (mm)	Code	Cost ex VAT	Cost inc VAT
800 x 800	One Door	760 - 785	410	ESQ813S	£924.72	£1109.66
900 x 900	One Door	860 - 885	505	ESQ913S	£924.72	£1109.66
800 x 900	One Door Offset	760 - 785 & 860 - 885	505	ESQ8913S	£924.72	£1109.66
1000 x 800	One Door Offset	760 - 785 & 960 - 985	495	ESQ81013S	£1104.14	£1324.97
800 x 1200	One Door Offset	760 - 785 & 1160 - 1185	470	ESQ81213S	£1159.35	£1391.22
900 x 1200	One Door Offset	860 - 885 & 1160 - 1185	470	ESQ91213S	£1214.55	£1457.46

Compatible Trays	Page
Roman Infinity Trays	90 - 91
Roman Low Level Trays	94 - 95

Embrace

Two Door Quadrant

with two sliding doors

Features and Benefits



Frame: Silver

Fast Fix System

Vertical adjustment: 50mm

Smooth running roller bearings

'Quick release' system for easy cleaning

Tray compatibility: 550mm radius



900 x 900 Two Door Quadrant

Two Door Curved Quadrant: EQ913S

Roman Low Level Tray: RLQ90

Shower Basket: RSB05

“ Avoid bathrooms fittings with these central opening doors ”

Size (mm)	Description	Adjustment (mm)	Aperture (mm)	Code	Cost ex VAT	Cost inc VAT
800 x 800	Twin Door	760 - 785	315	EQ813S	£814.30	£977.16
900 x 900	Twin Door	860 - 885	485	EQ913S	£814.30	£977.16
760 x 900	Twin Door Offset	720 - 745 & 860 - 885	400	EQ76913S	£814.30	£977.16
1000 x 1000	Twin Door	960 - 985	485	EQ1013S	£924.72	£1109.66
800 x 900	Twin Door Offset	760 - 785 & 860 - 885	405	EQ8913S	£814.30	£977.16
800 x 1000	Twin Door Offset	760 - 785 & 960 - 985	435	EQ81013S	£869.51	£1043.41
800 x 1200	Twin Door Offset	760 - 785 & 1160 - 1185	440	EQ81213S	£924.72	£1109.66
900 x 1200	Twin Door Offset	860 - 885 & 1160 - 1185	530	EQ91213S	£979.91	£1175.89

Compatible Trays	Page
Roman Infinity Trays	90 - 91
Roman Low Level Trays	94 - 95

Embrace

Hinged Door

Features and Benefits



Frame: Silver

Vertical adjustment: 50mm

Ball catch closing mechanism

Outward opening doors must be hinged from the wall

Compatible trays available



900 Alcove Fitting

Hinged Door: EL913S

900 x 900mm Roman Low Level: RLT90

Shower Basket: RSB05

Outward Opening



900 x 900 Corner-Fitting

Hinged Door: EL913S

Frameless Side Panel: EGL913S

Roman Low Level Tray: RLT90

Shower Basket: RSB01

Corner or Alcove Fitting

Size (mm)	Adjustment (mm)	Aperture (mm)	Code	Cost ex VAT	Cost inc VAT
760	710 - 760	530	EL7613S	£781.12	£937.34
800	750 - 800	570	EL13S	£781.12	£937.34
900	850 - 900	670	EL913S	£842.96	£1011.55
1000	950 - 1000	770	EL1013S	£867.97	£1041.56

For the full range of compatible Embrace Frameless Side Panels and In-Line Panels see page 55

“ Perfect door for out of true walls ”

Compatible Trays	Page
Roman Anti-Slip Trays	88 - 89
Roman Infinity Trays	90 - 91
Roman Low Level Trays	94 - 95

Level Access Sliding Door



1200 Alcove Fitting (Right Hand)

Sliding Door: ETLE1213SR (right hand)

Infinity Shower Tray: IA128

Shower Basket: RSB07

“ This enclosure is ideal for the whole family with its barrier free bottom rail options, spacious door opening and stylish ergonomic handle ”

Features and Benefits



Frame: Silver

Fast Fix System

Optional bottom rail

Easy release door function

Compatible with Embrace Side Panels

Left or Right handing must be specified

Compatible trays available

Not recommended when using ultra-low level shower trays to simulate a wetroom environment



1700 x 800 Corner Fitting (Right Hand)

Sliding Door (right hand): ETL1713SR

Side Panel: EGL813S

Infinity Shower Tray: RST178

Shower Basket: RSB07

Corner or Alcove Fitting

Size (mm)	Adjustment (mm)	Aperture (mm)	Code	Cost ex VAT	Cost inc VAT
1000	950 - 1000	350	ETLE1013S	£713.74	£856.49
1100	1050 - 1100	400	ETLE1113S	£741.35	£889.62
1200	1150 - 1200	450	ETLE1213S	£768.94	£922.73
1400	1350 - 1400	550	ETLE1413S	£800.50	£960.60
1700	1650 - 1700	700	ETLE1713S	£829.41	£995.29



Left Hand



Right Hand

Left or Right handing must be specified by adding R or L to code when ordering.

For the full range of compatible Embrace Frameless Side Panels and In-Line Panels see page 55

The minimalist nature of the product means if the shower head is directed at seal and component interfaces, some water may escape from the showering area. The product will perform as intended under normal showering conditions.

Compatible Trays	Page
Roman Anti-Slip Trays	88 - 89
Roman Infinity Trays	90 - 91
Roman Low Level Trays	94 - 95

Embrace

Sliding Door

Features and Benefits

GLASS THICKNESS 6 Millimetres	TOTAL HEIGHT 1900 Millimetres	REVERSIBLE 	GLASS PROTECTION ULTRA CARE BY JESMAN	TRUELIFE LIFETIME GUARANTEE
---	---	-----------------------	---	--

- Frame: Silver
- Fast Fix System
- PVC vertical seals
- Adjustable smooth running bearings
- 'Quick release' mechanism
- Compatible trays available



1200 Corner Fitting
Sliding Door: ET1213S
900mm Frameless Side Panel: EGL913S
Roman Low Level Tray: RLT129
Shower Basket: RS803



1200 Alcove Fitting
Sliding Door: ET1213S
Roman Low Level Tray: RLT129

“ Sliding doors are a key space saving feature ”

Corner or Alcove Fitting

Size (mm)	Adjustment (mm)	Aperture (mm)	Code	Cost ex VAT	Cost inc VAT
1000	950 - 1000	350	ET1013S	£634.88	£761.86
1100	1050 - 1100	400	ET1113S	£662.48	£794.98
1200	1150 - 1200	450	ET1213S	£690.08	£828.10
1400	1350 - 1400	550	ET1413S	£721.63	£865.96
1700	1650 - 1700	700	ET1713S	£750.55	£900.66

Compatible Trays	Page
Roman Anti-Slip Trays	88 - 89
Roman Infinity Trays	90 - 91
Roman Low Level Trays	94 - 95

For the full range of compatible Embrace Frameless Side Panels and In-Line Panels see page 55

Embrace

Pivot Door

Features and Benefits



Frame: Silver

Magnetic door closing

PVC vertical seals

Reduced opening into room due to hinge position

Outward opening doors must be hinged from the wall

Compatible trays available



900 x 900 Corner Fitting

Pivot Door: EF913S

Side Panel: EGL913S

Roman Low Level Tray: RLT90

Shower Basket: RSB06

Outward Opening



900 Alcove Fitting

Pivot Door: EF913S

Roman Low Level Tray: RLT90

“ Ideal space saving solution as the position of the hinge point means less protrusion into the bathroom ”

Corner or Alcove Fitting

Size (mm)	Adjustment (mm)	Aperture (mm)	Code	Cost ex VAT	Cost inc VAT
760	715 - 760	455	EF7613S	£628.41	£754.09
800	755 - 800	495	EF13S	£628.41	£754.09
900	855 - 900	595	EF913S	£679.46	£815.35

Compatible Trays	Page
Roman Anti-Slip Trays	88 - 89
Roman Infinity Trays	90 - 91
Roman Low Level Trays	94 - 95

For the full range of compatible Embrace Frameless Side Panels and In-Line Panels see page 55

Embrace

Bi-Fold Door

Features and Benefits

GLASS THICKNESS 6 Millimetres	TOTAL HEIGHT 1900 Millimetres	REVERSIBLE 	GLASS PROTECTION ULTRA CARE BY HESMAN	TRULIFE LIFETIME GUARANTEE
---	---	-----------------------	---	---

Frame: Silver

Smooth running roller bearings

Compatible trays available



1200 Alcove Fitting

Bi-Fold Door: EV1213S

Roman Low Level Tray: RLT129

Shower Basket: RSB02

Inward Opening



900 x 900 Corner Fitting

“ The in-fold design of the Embrace Bi-Fold Door creates more useable space and minimal bathroom intrusion. ”

Corner or Alcove Fitting

Size (mm)	Adjustment (mm)	Aperture (mm)	Code	Cost ex VAT	Cost inc VAT
760	715 - 760	470	EV7613S	£692.85	£831.42
800	755 - 800	510	EV13S	£692.85	£831.42
900	855 - 900	610	EV913S	£756.06	£907.27
1000	955 - 1000	710	EV1013S	£819.25	£983.10
1200	1155 - 1200	910	EV1213S	£844.77	£1013.72

Compatible Trays	Page
Roman Anti-Slip Trays	88 - 89
Roman Infinity Trays	90 - 91
Roman Low Level Trays	94 - 95

For the full range of compatible Embrace Frameless Side Panels and In-Line Panels see page 55

Embrace

Side Panels In-line Panels Neo-angle Panels

Features and Benefits



Frame: Silver

Compatible with Embrace corner posts and extension profiles

In-Line and Neo-Angle Panels are 8mm thick glass offering extra rigidity



Side Panel
900mm Pivot Door: EF913S
900mm Side Panel: EGL913S



In-Line Panel
760mm Bi-Fold Door: EV7613S
400mm In-Line Panel: EHL413S



Neo Angle Pack
1200 x 900mm Neo
Angle Pack: EP1213S

For Neo-Angle tray information see page 92

Size (mm)	Description	Adjustment (mm)	Glass Thickness (mm)	Product Suitability Code	Code	Cost ex VAT	Cost inc VAT
700	Side Panel	660 - 685	6	EF/EL/EV/ET/ETLE	EGL713S	£369.49	£443.39
760	Side Panel	720 - 745	6	EF/EL/EV/ET/ETLE	EGL7613S	£369.49	£443.39
800	Side Panel	760 - 785	6	EF/EL/EV/ET/ETLE	EGL813S	£369.49	£443.39
900	Side Panel	860 - 885	6	EF/EL/EV/ET/ETLE	EGL913S	£402.01	£482.41
1000	Side Panel	960 - 985	6	EF/EL/EV/ET/ETLE	EGL1013S	£435.59	£522.71
200	In-Line Panel	950 - 1000	8	EF76/EV76	EHL213S	£364.40	£437.28
300	In-Line Panel	1050 - 1100	8	EF76/EV76/EL76	EHL313S	£364.40	£437.28
400	In-Line Panel	1150 - 1200	8	EF/EV/EL	EHL413S	£364.40	£437.28
800	In-Line Panel	1532 - 1582	8	EV9/EL9/EF9	EHL813S	£402.97	£483.56
900 x 900	Neo Panel Pack	17 each side	8	EV76/EF76	EP913S*	£602.57	£723.08
1200 x 900	Neo Panel Pack	17 each side	8	EV76/EF76	EP1213S*	£645.19	£774.23
1900 high	Extension profile	35 (extra)		EF/EV/EL/ET/ETT	EZEXS	£78.68	£94.42

*For use with Bi-fold and Pivot Doors

Please note that other configurations are available for In-Line Panels.

Contact Customer Services 01325 328033

“ Perfection is achieved not when there is nothing more to add, but when there is nothing left to take away. ”

– Antoine de Saint-Exupery



Liberty Fluted Glass Wetroom Panels with Matt White Frame
See pages 62 - 63 for details

Black Grid

wetroom panels with matt black finish



1600 x 800 Corner Fitting

Corner Panel: KLCP9GPB

Corner Panel: KLCP8GPB

Brace Bars: LBBKC50SQB x 2

Infinity Shower Tray: IA168

“ The best way to predict the future is to create it ”

- Abraham Lincoln

Features and Benefits



Frame: Matt Black

Vertical adjustment: $\pm 7.5\text{mm}$

Tray compatibility: Tray or straight to floor using a wetroom system

Due to the nature of the product water integrity cannot be guaranteed - please consult your installer

Glass filled paint fired into the glass during toughening



1600 x 800 Corner Fitting

Corner Panel: KLCP9GPB

Corner Panel: KLCP8GPB

Pivoting Deflector Panel: KLSPM3GPB

Brace Bar: LBBKC50SQB

Infinity Shower Tray: IA168



Panels

Size (mm)	Description	Adjustment (mm)	Code	Cost ex VAT	Cost inc VAT
757	Black Grid Corner Panel	$\pm 7.5\text{mm}$	KLCP8GPB	£674.96	£809.95
857	Black Grid Corner Panel	$\pm 7.5\text{mm}$	KLCP9GPB	£718.96	£862.75
957	Black Grid Corner Panel	$\pm 7.5\text{mm}$	KLCP10GPB	£762.99	£915.59
1057	Black Grid Corner Panel	$\pm 7.5\text{mm}$	KLCP11GPB	£807.01	£968.41
1157	Black Grid Corner Panel	$\pm 7.5\text{mm}$	KLCP12GPB	£851.03	£1021.24
343	Black Grid Pivoting Deflector Panel		KLSPM3GPB	£400.49	£480.59

Brace Bars

Description	Size Max (mm)	Adjustment Min (mm)	Code	Cost ex VAT	Cost inc VAT
Low Level Brace Kit*	1030	Cut to suit	LBBK4590SQB	£147.65	£177.18
Side Panel Brace Kit - use with LBBK4590SQB	1000	Cut to suit	LBBKT90SQB	£147.65	£177.18
Ceiling Brace Kit	1030	Cut to suit	LBBKC50SQB	£147.65	£177.18

Compatible Trays	Page
Roman Anti-Slip Trays	88 - 89
Roman Infinity Trays	90 - 91
Roman Low Level Trays	94 - 95

*For use straight back to wall or can be cut to 45° if required for corner fixing as illustrated in 1 and 1(b) on page 75

Wetooms

Liberty

Wetoom Panels

with clear glass



1600 x 800 Corner Fitting
with Brushed Nickel finish

Corner Panel: KLCB813N

Pivoting Deflector Panel: KLSPM313N

Brace Bar: LBBKC50SQN

Infinity Shower Tray: IA168

Features and Benefits



Choice of colour finishes

Vertical adjustment: $\pm 7.5\text{mm}$

Tray compatibility: Tray or straight to floor using a wetroom system

Due to the nature of the product water integrity cannot be guaranteed - please consult your installer



1200 x 800 with Matt Black finish

Corner Panel: KLCP813B

Pivoting Deflector Panel: KLSPM313B

Brace Bar: LBBKC50SQB

Infinity Shower Tray: IA168



1200 Corner Panel
with Matt Black finish

Corner Panel: KLCP1213B

Brace Bar: LBBK4590SQB

Colour options for hardware:



Chrome
add S
to codes

Matt Black
add B
to codes

Brushed Nickel
add N
to codes

Polished Nickel
add PN
to codes

Brushed Brass
add BR
to codes

Matt White
add W
to codes

Panels

Size (mm)	Description	Adjustment (mm)	Code	Cost ex VAT	Cost inc VAT
757	Clear Glass Corner Panel	$\pm 7.5\text{mm}$	KLCP813	£498.88	£598.66
857	Clear Glass Corner Panel	$\pm 7.5\text{mm}$	KLCP913	£528.21	£633.85
957	Clear Glass Corner Panel	$\pm 7.5\text{mm}$	KLCP1013	£557.58	£669.10
1057	Clear Glass Corner Panel	$\pm 7.5\text{mm}$	KLCP1113	£586.91	£704.29
1157	Clear Glass Corner Panel	$\pm 7.5\text{mm}$	KLCP1213	£616.26	£739.51
343	Clear Glass Pivoting Deflector Panel		KLSPM313	£308.07	£369.68

Compatible Trays	Page
Roman Anti-Slip Trays	88 - 89
Roman Infinity Trays	90 - 91
Roman Low Level Trays	94 - 95

Brace Bars

Description	Size (mm) Max	Adjustment (mm) Min	Code S	Cost ex VAT	Cost inc VAT	Code B PN N BR W	Cost ex VAT	Cost inc VAT
Low Level Brace Kit*	1030	Cut to suit	LBBK4590SQ	£134.21	£161.05	LBBK4590SQ	£147.65	£177.18
Side Panel Brace Kit - use with LBBK4590SQ(B)	1000	Cut to suit	LBBKT90SQ	£134.21	£161.05	LBBKT90SQ	£147.65	£177.18
Ceiling Brace Kit	1030	Cut to suit	LBBKC50SQ	£129.43	£155.32	LBBKC50SQ	£147.65	£177.18

*For use straight back to wall or can be cut to 45° if required for corner fixing as illustrated in 1 and 1(b) on page 75

Liberty
Wetroom Panels
with Fluted Glass



1700 x 800 Corner Fitting
with Matt White finish

Corner Panel: KLCP121FW

Corner Panel: KLCP8FW

Brace Bar: LBBK4590SQW

Matt White Anti Slip Tray: RST178

“ Feel the groove ”

Features and Benefits



Vertical adjustment: ±7.5mm

Optional pivoting deflector panel

Choice of colour finishes available

Tray compatibility: Tray or straight to floor using a wetroom System

Due to the nature of the product water integrity cannot be guaranteed - please consult your installer



1700 Alcove Fitting with Black finish

Corner Panel: KLCP12FB

Brace Bar: LBBK4590SQB

Matt Grey Anti Slip Tray: RST178MG



1700 x 800 Corner Fitting with Chrome finish

Corner Panel: KLCP12FS

Deflector Panel: KLSPM3FS

Corner Panel: KLCP8FS

Brace Bar: LBBK4590SQ

Matt White Anti Slip Tray: RST178



Matt Black finish

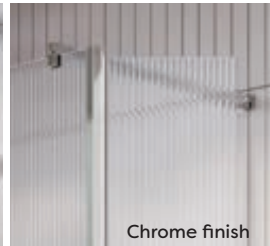

Chrome finish



Matt White finish

Colour options for hardware:



Chrome
add S
to codes

Matt Black
add B
to codes

Brushed Nickel
add N
to codes

Polished Nickel
add PN
to codes

Brushed Brass
add BR
to codes

Matt White
add W
to codes

Panels

Actual Size (mm)	Description	Adjustment (mm)	Code (mm)	Cost ex VAT	Cost inc VAT
757	Fluted Glass Corner Panel	±7.5mm	KLCP8F	£1012.44	£1214.93
857	Fluted Glass Corner Panel	±7.5mm	KLCP9F	£1078.47	£1294.16
957	Fluted Glass Corner Panel	±7.5mm	KLCP10F	£1144.49	£1373.39
1057	Fluted Glass Corner Panel	±7.5mm	KLCP11F	£1210.52	£1452.62
1157	Fluted Glass Corner Panel	±7.5mm	KLCP12F	£1276.54	£1531.85
343	Fluted Glass Deflector Panel	N/A	KLSPM3F	£600.73	£720.88

Compatible Trays	Page
Roman Anti-Slip Trays	88 - 89
Roman Infinity Trays	90 - 91
Roman Low Level Trays	94 - 95

Brace Bars

Description	Size (mm) Max	Adjustment (mm) Min	Code S	Cost ex VAT	Cost inc VAT	Code B PN N BR W	Cost ex VAT	Cost inc VAT
Low Level Brace Kit*	1030	Cut to suit	LBBK4590SQ	£134.21	£161.05	LBBK4590SQ	£147.65	£177.18
Side Panel Brace Kit - use with LBBK4590SQ(B)	1000	Cut to suit	LBBKT90SQ	£134.21	£161.05	LBBKT90SQ	£147.65	£177.18
Ceiling Brace Kit	1030	Cut to suit	LBBKC50SQ	£129.43	£155.32	LBBKC50SQ	£147.65	£177.18
Floor to Ceiling brace kit+	2700	Cut to suit	RF2C8KITSQ	£144.57	£173.48	RF2C8KITSQ	£159.01	£190.81

*For use straight back to wall or can be cut to 45° if required for corner fixing as illustrated in 1 and 1(b) on page 75

+ Floor to ceiling brace only available on Chrome or Black finish

Black Framed Wetroom Panel



1000 Panel with fluted glass

Corner Panel: N2SP10FB

Back to Wall Brace Kit:
NBBK4590SQB

1500 x 700 Matt White Anti Slip
Tray: RSRT157

Features and Benefits



Adjustment 785 - 800mm

Fully framed matt black frame

Back to wall or ceiling brace options



1000 Panel with clear glass

Corner Panel: N2SP1013B

Back to Wall Brace Kit:
NBBK4590SQB

1500 x 700 Matt White Anti Slip
Tray: RSRT157



1000 Panel with clear glass

Corner Panel: N2SP1013B

Ceiling Brace Kit: NBBK505SQB

1500 x 700 Matt White Anti Slip
Tray: RSRT157

Panels

Size (mm)	Description	Glass	Adjustment	Code	Cost ex VAT	Cost inc VAT
800	Black Framed Wetroom Panel	Clear	795 - 810mm	N2SP813B	£570.00	£684.00
900	Black Framed Wetroom Panel	Clear	895 - 910mm	N2SP913B	£620.00	£744.00
1000	Black Framed Wetroom Panel	Clear	995 - 1010mm	N2SP1013B	£670.00	£804.00
1200	Black Framed Wetroom Panel	Clear	1195 - 1210mm	N2SP1213B	£720.00	£864.00
800	Black Framed Wetroom Panel	Fluted	795 - 810mm	N2SP8FB	£900.00	£1080.00
900	Black Framed Wetroom Panel	Fluted	895 - 910mm	N2SP9FB	£1000.00	£1200.00
1000	Black Framed Wetroom Panel	Fluted	995 - 1010mm	N2SP10FB	£1100.00	£1320.00
1200	Black Framed Wetroom Panel	Fluted	1195 - 1210mm	N2SP12FB	£1300.00	£1560.00

Square Brace Bars

Description	Colour	Size (mm) Max	Adjustment (mm) Min	Code	Cost ex VAT	Cost inc VAT
Back to Wall Brace Kit	Black	1030	Cut to suit	NBBK4590SQB	£147.65	£177.18
Ceiling Brace Kit	Black	1030	Cut to suit	NBBK505SQB	£147.65	£177.18

Compatible Trays	Page
Roman Anti-Slip Trays	88 - 89
Roman Infinity Trays	90 - 91
Roman Low Level Trays	94 - 95

Pivoting Wetroom Panel



800 & 900 Pivoting Panels
Pivoting Panels: N2FSPM813B and
N2FSPM913B
Shower Basket: RSB07B



Features and Benefits



Frameless panels with 180° pivoting action

Bright silver or matt black profile

Chromed brass top caps

Tray compatibility: Tray or straight to floor using a wetroom System

Due to the nature of the product water integrity cannot be guaranteed - please consult your installer

Compatible trays available

Lead-time 10-14 days



800 Pivoting Panel
 Chrome Pivoting Panel: N2FSPM813S
 1600 x 800 Roman Anti-Slip Tray:
 RST168
 Shower Basket: RSB07



Colour options for hardware:



Chrome Matt Black

Panels

Size (mm)	Description	Frame	Adjustment	Code	Cost ex VAT	Cost inc VAT
400	Pivoting Wetroom Panel	Chrome	360-380mm	N2FSPM413S	£490.00	£588.00
500	Pivoting Wetroom Panel	Chrome	460-480mm	N2FSPM513S	£520.00	£624.00
800	Pivoting Wetroom Panel	Chrome	760-780mm	N2FSPM813S	£600.00	£720.00
900	Pivoting Wetroom Panel	Chrome	860-880mm	N2FSPM913S	£650.00	£780.00
400	Pivoting Wetroom Panel	Black	360-380mm	N2FSPM413B	£490.00	£588.00
500	Pivoting Wetroom Panel	Black	460-480mm	N2FSPM513B	£520.00	£624.00
800	Pivoting Wetroom Panel	Black	760-780mm	N2FSPM813B	£600.00	£720.00
900	Pivoting Wetroom Panel	Black	860-880mm	N2FSPM913B	£650.00	£780.00

Compatible Trays	Page
Roman Anti-Slip Trays	88 - 89
Roman Infinity Trays	90 - 91
Roman Low Level Trays	94 - 95

Folding Wetroom Panels



1000 Wetroom Panel
N2VC1013S

Inward or Outward Opening

“ This innovative wetroom panel creates a large and open space to enter the showering area. ”

Features and Benefits



Frameless folding panels with 180° pivoting action

Bright silver profile

Chromed brass hinges

Chromed brass top caps

Clear seals

Tray compatibility: Tray or straight to floor using a wetroom System

Due to the nature of the product water integrity cannot be guaranteed - please consult your installer

Compatible trays available



Folded position

Folding positions:

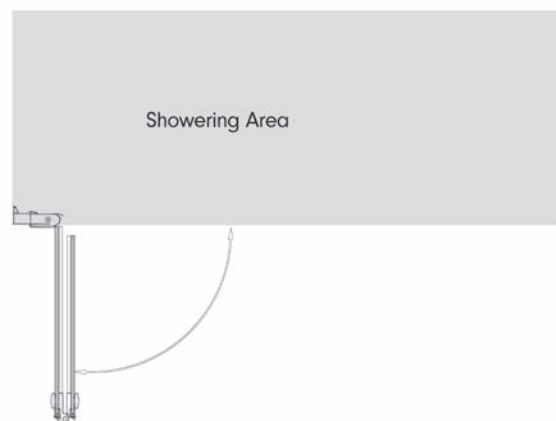
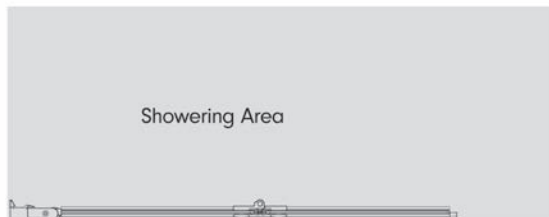

Panel Size (mm)	Adjustment (mm)	Code	Cost ex VAT	Cost inc VAT
800	760 - 780	N2VC813S	£818.16	£981.79
900	860 - 880	N2VC913S	£879.02	£1054.82
1000	960 - 980	N2VC1013S	£939.89	£1127.87

Compatible Trays	Page
Roman Anti-Slip Trays	88 - 89
Roman Infinity Trays	90 - 91
Roman Low Level Trays	94 - 95

Select Wetroom Solutions

The perfect way to create a wetroom - tailored to your own style

GLASS THICKNESS 10 <small>Millimetres</small>	or	GLASS THICKNESS 8 <small>Millimetres</small>	TOTAL HEIGHT 2000 <small>Millimetres</small>	REVERSIBLE 	GLASS PROTECTION ULTRA CARE <small>BY ROMAN</small>	TRUELIFE LIFETIME GUARANTEE
---	----	--	--	---	---	--

Roman's Select Collection features our Wetroom Panel options, which can be fitted to our low level shower trays or straight to floor to create a true wetroom. We present a number of panel sizes and options, to help you create your perfect bathroom sanctuary. Included are the various configurations that are available to suit you and your bathroom.

All Panels are 2000mm high and available in either 8mm glass thickness or 10mm glass thickness and either chrome, matt black, brushed nickel or brushed brass finish, clear glass or Black Grid design. Bracing is recommended for use with all wet room panel sizes.



- 1700 x 800 3 sided wetroom with Brushed Brass finish
- 900mm Corner Panel: VIOSP913BR
- 800mm Corner Panel: VIOSP813BR
- Floor to Ceiling Brace Bar: RF2C8KITSQBR
- Chrome Shower Basket: RSBO1
- Matt White Infinity Tray: IA178

Selecting your configuration

Select the size of panel you require in either 8 or 10mm glass thickness; select your colour; select your configuration; select between a fixed or pivoting deflector panel; and select your desired bracing bars.



1700 x 900 3 sided wetroom with matt black finish

x2 900mm Corner Panels: VIOSP913B

1000mm Glass to Glass Panel: VIOFP1013B

300mm Pivoting Deflector Panel: VIOSPM313B

Brace Bars: LBBK4590SQB

Black Shower Basket: RSB01B

Colour options for hardware:



Chrome
add S
to code

Matt Black
add B
to code

Brushed Nickel
add N
to code

*Brushed Brass
add BR
to code

*only available in corner panels and pivoting deflectors



1000 wetroom panel with chrome finish

1000mm Corner Panel: VIOSP1013S

Brace Bars: LBBK4590

Wetrooms

This is just a selection of configurations which can be created using either 8mm or 10mm Select glass panels.

Select Wetrooms

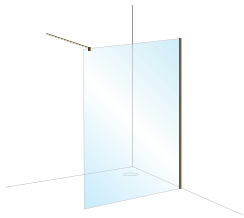

- Corner Panel
- Low Level Brace kit

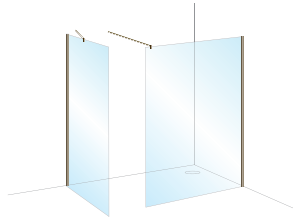

- x2 Corner Panels
- x2 Low Level Brace kits

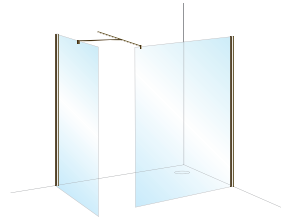

- x2 Corner Panels
- Low Level Brace kit
- Side Panel Brace kit

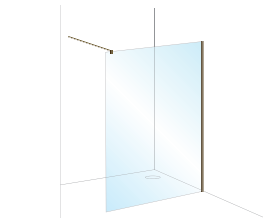

- Corner Panel (in Alcove)
- Low Level Brace kit



- Corner Panel
- Floor to Ceiling Brace kit

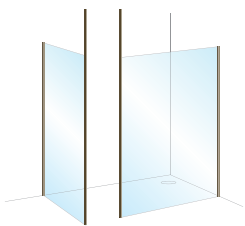

- x2 Corner Panels
- x2 Floor to Ceiling Brace kit

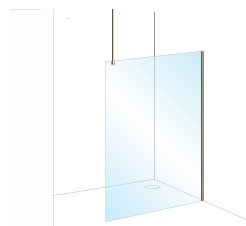

- Corner Panel
- Ceiling Brace kit

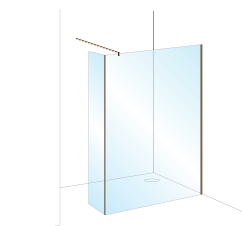

- Corner Panel
- Pivoting Deflector Panel
- Low Level Brace kit

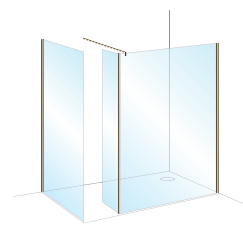

- x2 Corner Panels
- Fixed Deflector
- Low Level Brace kit

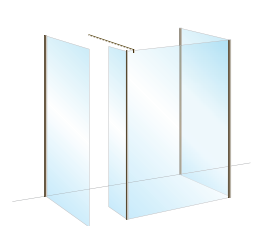

- x2 Corner Panel
- Glass to Glass Panel
- Deflector Panel
- Low Level Brace kit

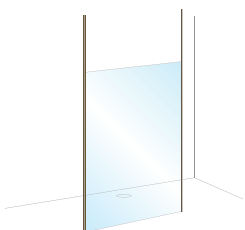

- Linear Panel
- x2 Floor to Ceiling Brace kit

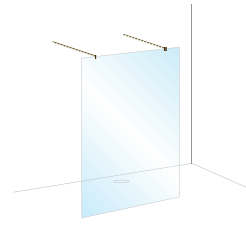

- Linear Panel
- x2 Low Level Brace kit

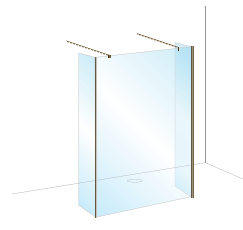

- Linear Panel
- x2 Pivoting deflector panels
- x2 Low Level Brace kit

Please see pages 73 - 79 for more information

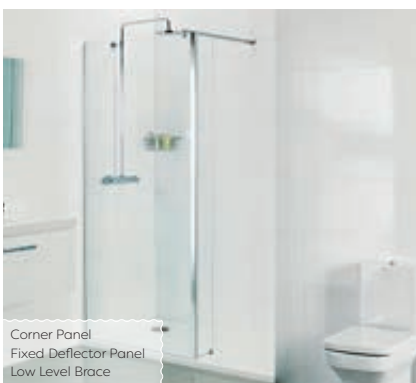

Corner Panel
Fixed Deflector Panel
Low Level Brace



Corner Panel x2
Fixed Deflector Panel
Low Level Brace with
Side Panel Brace

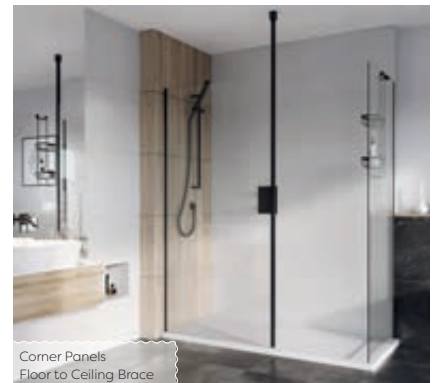

Corner Panels
Floor to Ceiling Brace

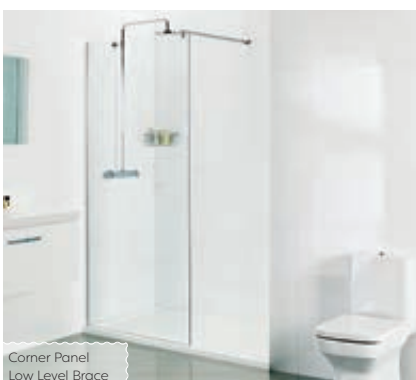

Corner Panel
Low Level Brace

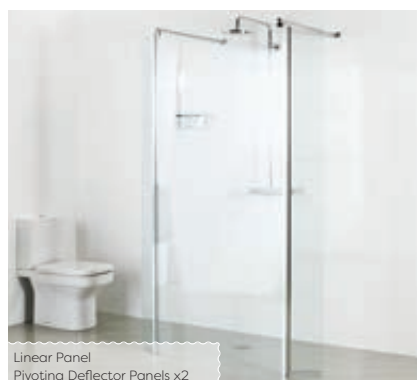

Linear Panel
Pivoting Deflector Panels x2



Corner Panel x2
Glass to Glass Panel
Pivoting Deflector Panel
Low Level Brace x2

Select Wetroom Panels

All panels are 2000mm in height
No brace bars included - please see pages 74-75
to select your style of Bracing required.



N.B. Due to the nature of the product water integrity cannot be guaranteed - please consult your installer

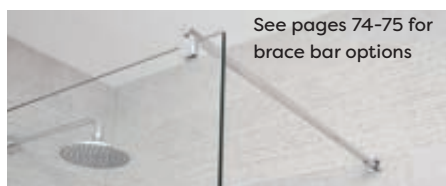

Colour options for hardware:



Chrome add S to code
Matt Black add B to code
Brushed Nickel add N* to code
Brushed Brass add BR to code

* N and BR only available in corner panels and pivoting deflectors

8mm Glass

10mm Glass

Description	Actual Width (mm)	Order Code	Cost ex VAT	Cost inc VAT	Actual Width (mm)	Order Code	Cost ex VAT	Cost inc VAT
Corner Panel (includes wall fixing kit allowing +/- 7.5mm of vertical adjustment).								
400 Corner Panel	365mm	V8SP413	£267.26	£320.71	350mm	V10SP413	£276.16	£331.39
500 Corner Panel	465mm	V8SP513	£279.39	£335.27	450mm	V10SP513	£299.64	£359.57
600 Corner Panel	565mm	V8SP613	£291.51	£349.81	550mm	V10SP613	£332.01	£398.41
700 Corner Panel	665mm	V8SP713	£303.67	£364.40	650mm	V10SP713	£348.21	£417.85
760 Corner Panel	725mm	V8SP7613	£311.77	£374.12	710mm	V10SP7613	£360.35	£432.42
800 Corner Panel	765mm	V8SP813	£315.82	£378.98	750mm	V10SP813	£368.45	£442.14
900 Corner Panel	865mm	V8SP913	£327.97	£393.56	850mm	V10SP913	£384.65	£461.58
1000 Corner Panel	965mm	V8SP1013	£344.16	£412.99	950mm	V10SP1013	£404.89	£485.87
1100 Corner Panel	1065mm	V8SP1113	£366.84	£440.21	1050mm	V10SP1113	£431.63	£517.96
1200 Corner Panel	1165mm	V8SP1213	£389.51	£467.41	1150mm	V10SP1213	£458.35	£550.02
1400 Corner Panel	1365mm	V8SP1413	£412.18	£494.62	1350mm	V10SP1413	£485.07	£582.08
Deflector Panel (includes fixed or pivoting corner fixing kit). See page 76 for more details.								
200 Fixed Deflector Panel	226mm	V8SPL213	£198.04	£237.65	226mm	V10SPL213	£234.84	£281.81
200 Pivoting Deflector Panel	243mm	V8SPM213	£255.09	£306.11	243mm	V10SPM213	£303.57	£364.28
300 Pivoting Deflector Panel	343mm	V8SPM313	£262.18	£314.62	343mm	V10SPM313	£312.00	£374.40
400 Pivoting Deflector Panel	443mm	V8SPM413	£269.25	£323.10	443mm	V10SPM413	£320.42	£384.50
Linear Panel (includes freestanding floor fixing kit).								
1000 Linear Panel	955mm	V8LP1013	£344.16	£412.99	940mm	V10LP1013	£404.89	£485.87
1100 Linear Panel	1055mm	V8LP1113	£366.84	£440.11	1040mm	V10LP1113	£431.63	£517.96
1200 Linear Panel	1155mm	V8LP1213	£389.51	£467.41	1140mm	V10LP1213	£458.35	£550.02
1400 Linear Panel	1355mm	V8LP1413	£412.18	£494.62	1340mm	V10LP1413	£485.07	£582.08
Glass to Glass Panel (includes fixing kit)								
600 Glass to Glass Panel	567mm	V8FP613	£291.51	£349.81	556mm	V10FP613	£332.01	£398.41
700 Glass to Glass Panel	667mm	V8FP713	£303.67	£364.40	656mm	V10FP713	£348.21	£417.85
760 Glass to Glass Panel	727mm	V8FP7613	£311.77	£374.12	716mm	V10FP7613	£360.35	£432.42
800 Glass to Glass Panel	767mm	V8FP813	£315.82	£378.98	756mm	V10FP813	£368.45	£442.14
900 Glass to Glass Panel	867mm	V8FP913	£327.97	£393.56	856mm	V10FP913	£384.65	£461.58
1000 Glass to Glass Panel	967mm	V8FP1013	£344.16	£412.99	956mm	V10FP1013	£404.89	£485.87
1100 Glass to Glass Panel	1067mm	V8FP1113	£366.84	£440.21	1056mm	V10FP1113	£431.63	£517.96
1200 Glass to Glass Panel	1167mm	V8FP1213	£389.51	£467.41	1156mm	V10FP1213	£458.35	£550.02

Vinyl Floor Contour Profile Kit

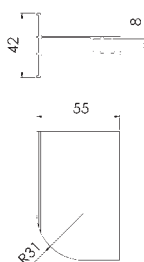
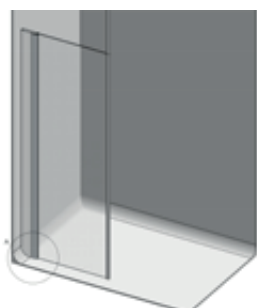

Description	Code	Cost ex VAT	Cost inc VAT
Vinyl Floor Contour Profile Kit	BPO01S	£67.20	£80.64

Compatible Trays	Page
Roman Anti-Slip Trays	88 - 89
Roman Infinity Trays	90 - 91
Roman Low Level Trays	94 - 95

Wetrooms

Roman provides a number of different styles of bracing bars, which can be used with 8mm and 10mm glass thicknesses. We offer all configurations that may be required and they can be cut and trimmed to the size required during installation to allow maximum flexibility and use of space. Bracing kits are used to provide added support for the glass and ensure that it is securely fitted in place.

We have something to suit the enclosure style, your bathroom area and your preference, to present the highest level of stability.

Our Square brace bars are now available in Black, Chrome, Brushed Nickel or Brushed Brass.

Brace Bars

Select Wetroom Solutions



Round Brace Bars

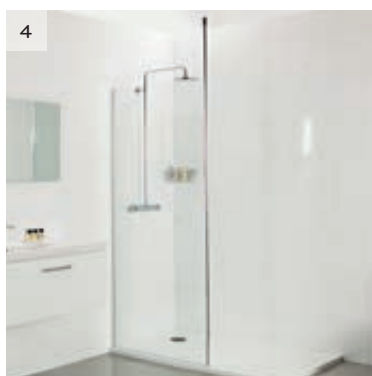
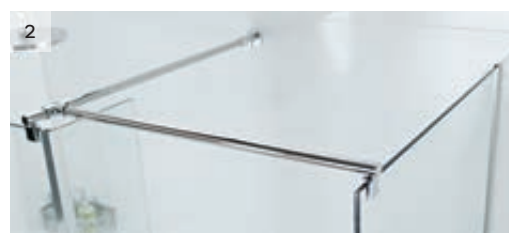
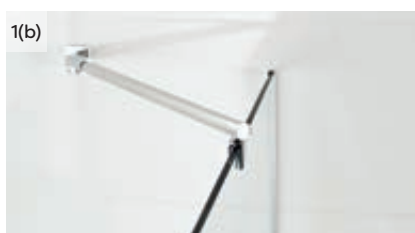

Key:

1. Low Level Brace Kit *
2. Side Panel Brace Kit (for use with LBBK4590*)
3. Ceiling Brace Kit
4. Floor to Ceiling Brace Kit
5. Low Level Brace Kit (90° only)

Description	For use with glass thickness	Colour Finish	Size (mm) Max	Adjustment (mm) Min	Code	Cost ex VAT	Cost inc VAT
Low Level Brace Kit*	6mm / 8mm / 10mm	Chrome	1030	Cut to suit	LBBK4590	£134.21	£161.05
Side Panel Brace Kit (use with LBBK4590)	6mm / 8mm / 10mm	Chrome	1000	Cut to suit	LBBKT90	£134.21	£161.05
Ceiling Brace Kit	6mm / 8mm / 10mm	Chrome	1030	Cut to suit	LBBKC50	£129.43	£155.32
Floor to Ceiling Brace Kit	8mm	Chrome	2700 high	Cut to suit	RF2C8KIT	£144.57	£173.48
Low Level Brace Kit (90° only)	6mm / 8mm / 10mm	Chrome	1030	Cut to suit	LBBK90	£104.15	£124.98

*For use straight back to wall or can be cut to 45° if required for corner fixing as illustrated in 1 and 1(b).

N.B. Adjustments are measured from the wall to the inside of the glass.



Square Brace Bars



Key:

1. Low Level Brace Kit *
2. Side Panel Brace Kit (for use with LBBK4590SQ*)
3. Ceiling Brace Kit
4. Floor to Ceiling Brace Kit

Description	For use with glass thickness	Colour	Size (mm) Max	Adjustment (mm) Min	Code	Cost ex VAT	Cost inc VAT
Low Level Brace Kit*	6mm / 8mm / 10mm	Chrome	1030	Cut to suit	LBBK4590SQ	£134.21	£161.05
Side Panel Brace Kit (use with LBBK4590SQ)	6mm / 8mm / 10mm	Chrome	1000	Cut to suit	LBBKT90SQ	£134.21	£161.05
Ceiling Brace Kit	6mm / 8mm / 10mm	Chrome	1030	Cut to suit	LBBKC50SQ	£129.43	£155.32
Floor to Ceiling Brace Kit	8mm	Chrome	2700 high	Cut to suit	RF2C8KITSQ	£144.57	£173.48
Low Level Brace Kit*	6mm / 8mm / 10mm	Black	1030	Cut to suit	LBBK4590SQB	£147.65	£177.18
Side Panel Brace Kit (use with LBBK4590SQB)	6mm / 8mm / 10mm	Black	1000	Cut to suit	LBBKT90SQB	£147.65	£177.18
Ceiling Brace Kit	6mm / 8mm / 10mm	Black	1030	Cut to suit	LBBKC50SQB	£147.65	£177.18
Floor to Ceiling Brace Kit	8mm	Black	2700 high	Cut to suit	RF2C8KITSQB	£159.01	£190.81
Low Level Brace Kit*	6mm / 8mm / 10mm	Brushed Brass	1030	Cut to suit	LBBK4590SQBR	£147.65	£177.18
Side Panel Brace Kit (use with LBBK4590SQBR)	6mm / 8mm / 10mm	Brushed Brass	1000	Cut to suit	LBBKT90SQBR	£147.65	£177.18
Ceiling Brace Kit	6mm / 8mm / 10mm	Brushed Brass	1030	Cut to suit	LBBKC50SQBR	£147.65	£177.18
Floor to Ceiling Brace Kit	6mm	Brushed Brass	2700 high	Cut to suit	RF2C8KITSQBR	£159.01	£190.81
Low Level Brace Kit*	6mm / 8mm / 10mm	Brushed Nickel	1030	Cut to suit	LBBK4590SQN	£147.65	£177.18
Side Panel Brace Kit (use with LBBK4590SQN)	6mm / 8mm / 10mm	Brushed Nickel	1000	Cut to suit	LBBKT90SQN	£147.65	£177.18
Ceiling Brace Kit	6mm / 8mm / 10mm	Brushed Nickel	1030	Cut to suit	LBBKC50SQN	£147.65	£177.18
Floor to Ceiling Brace Kit*	8mm	Brushed Nickel	2700 high	Cut to suit	RF2C8KITSQN	£159.01	£190.81

*For use straight back to wall or can be cut to 45° if required for corner fixing as illustrated in 1 and 1(b).

N.B. Adjustments are measured from the wall to the inside of the glass.

Wetrooms

Select Wetroom Solutions



Deflector Panels

Fixed or Pivoting



1700 x 800 3 sided fitting

Corner Panel V8SP813S (x2)

Front Panel V8FP913S

Pivoting Deflector Panel V8SPM213S

Brace Bars LBBK4590SQBBR, LBBK190SQ

Infinity Shower Tray IAG178

Shower Basket RSB01

Adjustable Foot



Pivoting Panel

Features and Benefits:

- Retro Fitable
- Improve water integrity
- Rotates through 180°
- Smooth pivot motion
- Stows when not in use to improve access

Due to the nature of the product water integrity cannot be guaranteed - please consult your installer

Fixed Panel

Features and Benefits:

- Retro Fitable
- Improve water integrity
- Panel Foot adjusts from 4mm to 29mm to accommodate high and low level trays
- Panel foot is chromed brass with soft rubber base



“ Water is the driving force of all nature ”
- Leonardo da Vinci

Wetrooms

Select

Black Grid Wetroom Panel



“ A stylish screen to make an impression ”

Features and Benefits



Frame: Matt Black

Vertical adjustment: ± 7.5 mm

Tray compatibility: Tray or straight to floor using a wetroom system

Due to the nature of the product water integrity cannot be guaranteed - please consult your installer

Glass filled paint fired into the glass during toughening



For black brace bar options please see page 75

Panels

Size (mm)	Description	Actual Size (mm)	Adjustment	Code	Cost ex VAT	Cost inc VAT
800	Black Grid Wetroom Panel	765	+/- 7.5mm	V8SP8GPB	£400.00	£480.00
900	Black Grid Wetroom Panel	865	+/- 7.5mm	V8SP9GPB	£420.00	£504.00
1000	Black Grid Wetroom Panel	965	+/- 7.5mm	V8SP10GPB	£440.00	£528.00
1100	Black Grid Wetroom Panel	1065	+/- 7.5mm	V8SP11GPB	£470.00	£564.00
1200	Black Grid Wetroom Panel	1165	+/- 7.5mm	V8SP12GPB	£500.00	£600.00
300	Pivoting Detector Panel	343	N/A	V8SPM3GPB	£320.00	£384.00

Compatible Trays	Page
Roman Anti-Slip Trays	88 - 89
Roman Infinity Trays	90 - 91
Roman Low Level Trays	94 - 95

Colossus Curved Panel



1700 Colossus
1700mm Colossus: V8C13S
Shower Tray (right hand): FC1R
Shower Basket: RSB06



1450 Colossus with 1 Side Panel
1450mm Colossus: V8CG213S
Shower Tray (right hand): FCT1R
Shower Basket: RSB06



“The perfect bath replacement product”

Features and Benefits



Bright silver frame

25mm vertical adjustment

Chrome top caps

Tray Compatibility: Suitable for dedicated tray or straight to floor using a wetroom system

Due to the nature of the product water integrity cannot be guaranteed - please consult your installer

Compatible trays available



1600 Colossus with Side Panel
1600mm Colossus: V8GP13S
Shower Tray (Left Hand): V8GTL



Tray Size (mm)	Description	Fixed Panel (mm)	Height (mm)	Adjustments (mm)	Aperture (mm)	Tray Compatibility Code	Code	Cost ex VAT	Cost inc VAT
1700	Colossus	1202	1950	25	478	FC1	V8C13S	£1276.66	£1531.99
1700	Colossus + 1 Side Panel	1202	1950	25	456	FC1	V8CG13S	£1594.10	£1912.92
1700	Colossus + Return Panel	1202	1950	25	456	FC1	V8CGM13S	£1594.10	£1912.92
1700	Colossus + 2 Side Panels	1202	1950	25	456	FC1	V8CGR13S	£1911.53	£2293.84
1600	Curved Panel With Towel Rail	775	2000	25	791	V8GT	V8GP13S	£1111.05	£1333.26
800	Optional Side Panel	706	2000	25	762	V8GT	V8GPA	£332.10	£398.52
1450	Colossus	963	1950	25	475	FCT1	V8C213S	£1111.05	£1333.26
1450	Colossus + 1 Side Panel	963	1950	25	442	FCT1	V8CG213S	£1428.48	£1714.18
1450	Colossus + Return Panel	963	1950	25	442	FCT1	V8CGM213S	£1428.48	£1714.18
1450	Colossus + 2 Side Panels	963	1950	25	442	FCT1	V8CGR213S	£1745.91	£2095.09

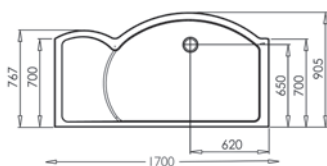

1700 FC1L - Left Hand Low Level Tray



1600 V8GTL - Left Hand Low Level Tray

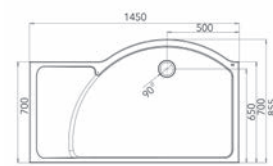

1450 FCT1L - Left Hand Low Level Tray

Tray handing must be specified - see page 93 for tray information

Curved Wetroom Panel



1400 Curved Panel
with Side Panel
1400mm V8HP13S
Side Panel V8HPA
Troy V8HTL (left hand)

“ The curved glass sits perfectly in the specially designed tray. ”

Features and Benefits

GLASS THICKNESS
8
Millimetres

TOTAL HEIGHT
2030
Millimetres

REVERSIBLE

GLASS PROTECTION
ULTRA CARE
BY REMAN

TRUELIFE
LIFETIME
GUARANTEE

Glass height 2000mm

Height to top of brace bar 2030mm

25mm Vertical Adjustment

Chrome top caps

Tray Compatibility: Suitable for dedicated tray or straight to floor using a wetroom system

Due to the nature of the product water integrity cannot be guaranteed - please consult your installer

Compatible trays available



1400 Curved Panel
1400mm V8HP13S
Tray V8HTL (left hand)

Panel Size (mm)	Tray Size (mm)	Description	Adjustment (mm)	Code	Cost ex VAT	Cost inc VAT
806	1400	Lumin8 Curved Panel	25	V8HP13S	£655.57	£786.68
663	900	Lumin8 Optional Side Panel	25	V8HPA	£346.78	£416.14

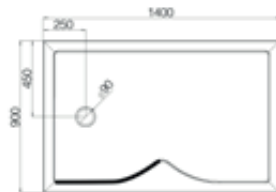

1400 V8HTL - Left Hand Low Level Tray

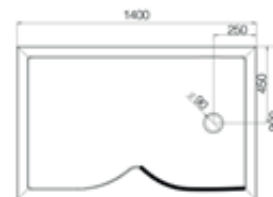

1400 V8HTR - Right Hand Low Level Tray

Tray handing must be specified - see page 93 for tray information



Corner Panel
Embrace 900mm
Corner Panel: ESP913S
Shower Basket: RSB01



Linear Panel
Embrace 927mm Linear
Panel ELLP1013S
Shower Basket: RSB04



900 Corner Panel
Embrace 1100mm
Embrace 200mm Pivoting L Panel:
ESPM213S fitted to
Gloss Infinity Tray: IAG168
Shower Basket: RSB01

“Roman’s wetroom panels offer style and sophistication with a seamless glass panel and sleek chrome profile.”

Features and Benefits



Frame: Silver

LBBK4590 brace bar supplied with panel sizes 1000mm and above

Two LBBK4590 brace bars supplied with Linear Panels

Chromed top caps

Maximum distance from wall when using bracing 1060mm

ESP - reversible for left or right hand fixing

Due to the nature of the product water integrity cannot be guaranteed - please consult your installer

Tray compatibility: Tray or straight to floor using a wetroom

Optional brace bar included

Silicone Free Wall Fixing

Left or Right handing must be specified when ordering

Compatible trays available



LBBK4590 brace bar



LBBK4590 brace bar cut to 45°

For alternative styles of bracing bars please see pages 74 - 75

Wetroom Panels

Size (mm)	Description	Adjustment (mm)	Code	Cost ex VAT	Cost inc VAT
600	Corner Panel	578 - 603	ESP613S	£418.73	£502.48
700	Corner Panel	678 - 703	ESP713S	£418.73	£502.48
800	Corner Panel	778 - 803	ESP813S	£418.73	£502.48
900	Corner Panel	878 - 903	ESP913S	£455.28	£546.34
1000	Corner Panel	978 - 1003	ESP1013S	£617.49	£740.99
1100	Corner Panel	1078 - 1103	ESP1113S	£642.38	£770.86
1200	Corner Panel	1178 - 1203	ESP1213S	£667.31	£800.77
1400	Corner Panel	1378 - 1403	ESP1413S	£724.45	£869.34
827	Linear Panel	35 in wall cup	ELLP913S	£649.08	£778.90
927	Linear Panel	35 in wall cup	ELLP1013S	£698.92	£838.70
1127	Linear Panel	35 in wall cup	ELLP1213S	£748.75	£898.50
1327	Linear Panel	35 in wall cup	ELLP1413S	£798.59	£958.31

Compatible Trays	Page
Roman Anti-Slip Trays	88 - 89
Roman Infinity Trays	90 - 91
Roman Low Level Trays	94 - 95

Pivoting 'L' Panel



Size (mm)	Adjustments (mm)	Code	Cost ex VAT	Cost inc VAT
200	n/a	ESPM213S	£248.43	£298.12
300	n/a	ESPM313S	£255.34	£306.41
400	n/a	ESPM413S	£262.23	£314.68
Where fitting with return panel is required please use one of the following				
600	578 - 603	ESP613S	£418.73	£502.48
800	778 - 803	ESP813S	£418.73	£502.48
900	878 - 903	ESP913S	£418.73	£502.48

Pivoting 'L' Panel

Retro-fit panel suitable for all ESP and ELLP panels

Rotates through 180°

Smooth pivoting motion

Chromed decorative top caps



Anti Slip Trays



White Anti-Slip Tray

Features and Benefits

Ultra low 50mm profile

Manufactured using Roman Stone solid surface technology

One angle of slope to waste to maximise flow rating

Fast flow waste included

Solid Surface Plinth and Leg Set available if required - Total height inc. tray 150mm



“ Matt finish cannot wear - permanent anti-slip ”



Anti Slip Trays

Matt Trays have been tested to:

BS7976-2:2002+A1:2013 - Slip potential - low DIN 51097:1992 Class C

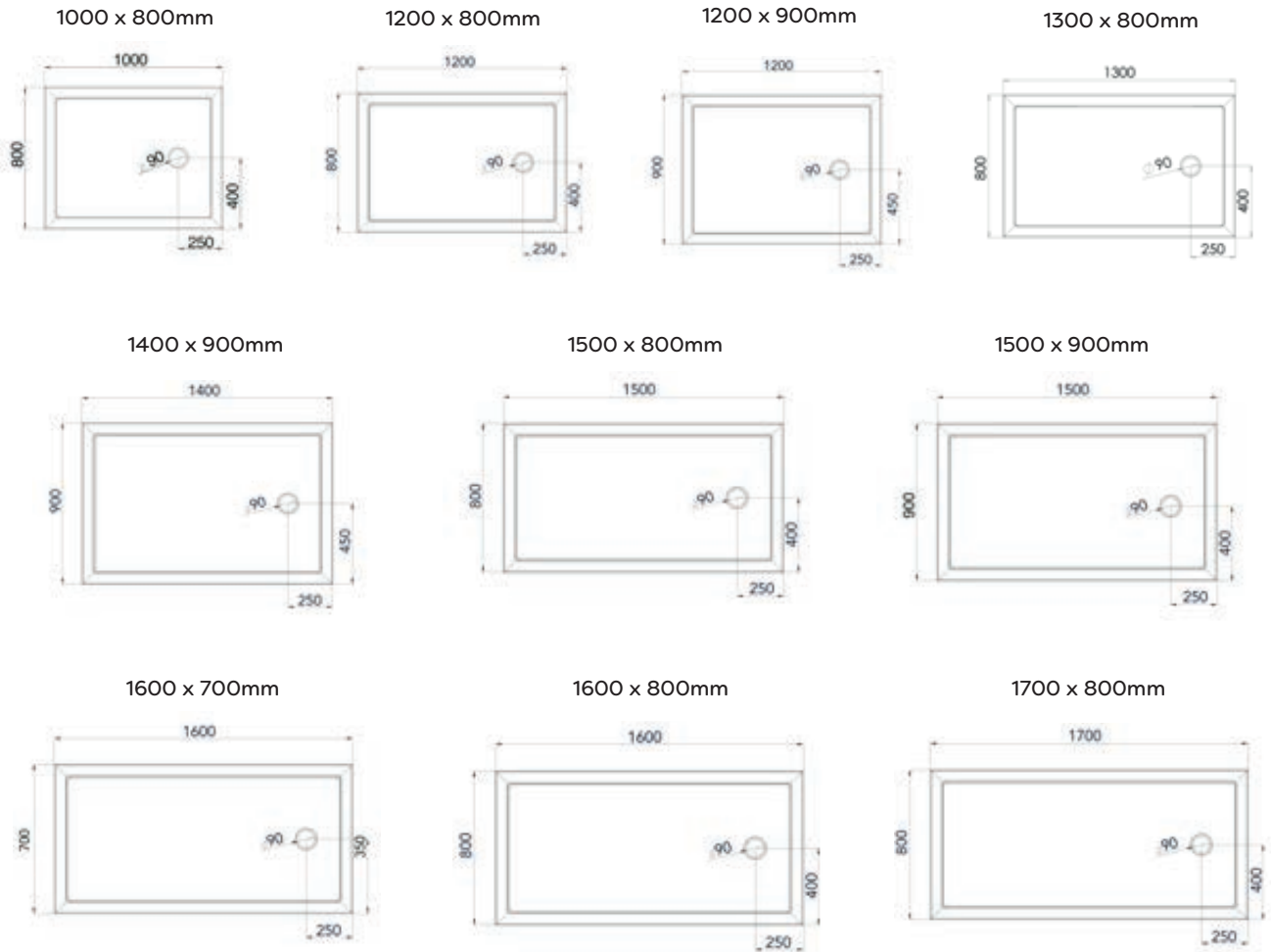
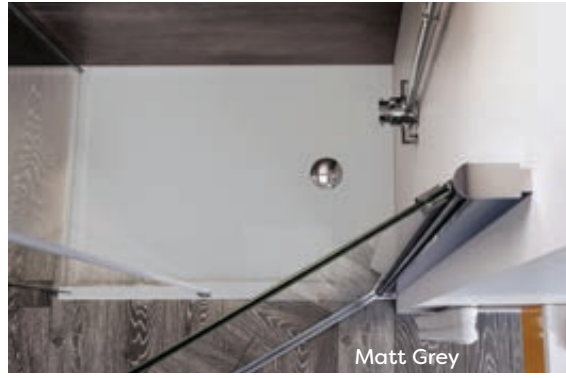
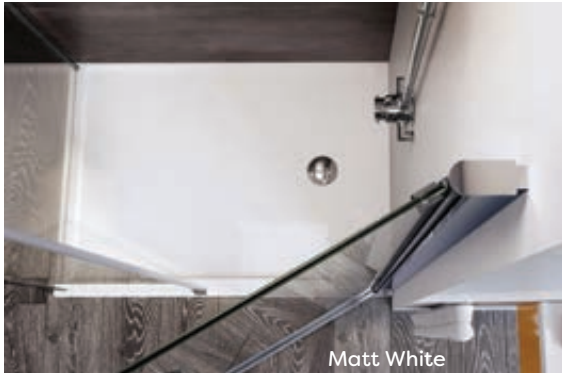

Tray with Leg Kit

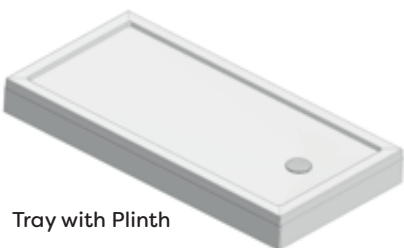

Tray with Plinth

Tray Size (mm)	Description	Finish	White Tray Code	Grey Tray Code	Cost ex VAT	Cost inc VAT
1000 x 800	Anti-Slip Tray	Matt	RST108	RST108MG	£462.19	£554.63
1200 x 800	Anti-Slip Tray	Matt	RST128	RST128MG	£526.48	£631.78
1200 x 900	Anti-Slip Tray	Matt	RST129	RST129MG	£548.36	£658.03
1300 x 800	Anti-Slip Tray	Matt	RST138	RST138MG	£581.20	£697.44
1400 x 900	Anti-Slip Tray	Matt	RST149	RST149MG	£614.04	£736.85
1500 x 700	Anti-Slip Tray	Matt	RST157	RST157MG	£624.62	£749.54
1500 x 800	Anti-Slip Tray	Matt	RST158	RST158MG	£624.62	£749.54
1500 x 900	Anti-Slip Tray	Matt	RST159	RST159MG	£635.93	£763.12
1600 x 700	Anti-Slip Tray	Matt	RST167	RST167MG	£635.93	£763.12
1600 x 800	Anti-Slip Tray	Matt	RST168	RST168MG	£635.93	£763.12
1700 x 800	Anti-Slip Tray	Matt	RST178	RST178MG	£647.23	£776.68
PLINTH AND LEG SET						
Standard Riser Kit			RSTRK01	RSTRK02	£205.11	£246.13

Infinity Trays

Level Access Installation



Our Infinity Trays offer a breakthrough in technology as they can be installed straight to joists so that once the floor tiles are laid it creates level entry access into the shower area. Manufactured from Roman Stone, the Infinity Trays are strong and durable. This product provides the added reassurance of a tray, with the minimalist design and level access of a wetroom. The waste is suitable for power shower systems and carries away 25 litres of water per minute.

Features and Benefits

Ultra low profile 40mm nominal height

Gloss or Matt* finish available in white

Manufactured using Roman Stone Solid Surface Technology

One angle of slope to waste to maximise flow rating

Fast flow waste included, fully concealed with solid surface cover piece

Due to the nature of the product water integrity cannot be guaranteed when fitting with a wetroom panel. Please consult your installer

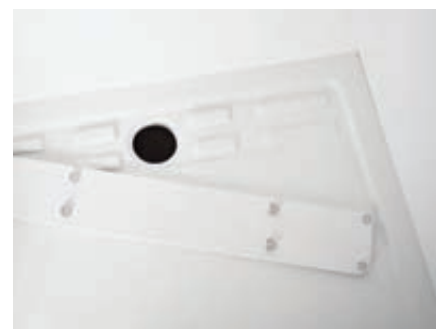

Anti Slip Trays

Matt Trays have been tested to:

BS7976-2:2002+A1:2013 - Slip potential - low DIN 51097:1992 Class C

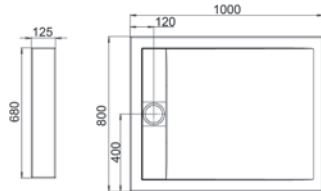

1000 x 800mm

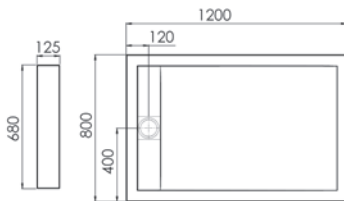

1200 x 800mm

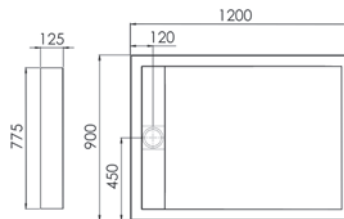

1200 x 900mm

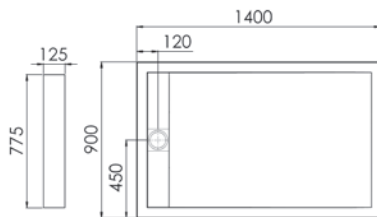

1400 x 900mm

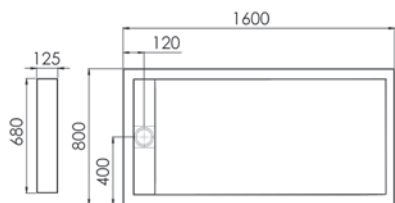

1600 x 800mm

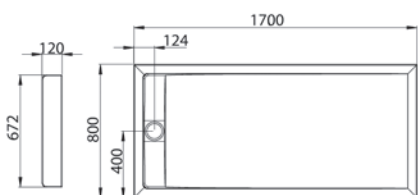

1700 x 800mm

Anti-Slip options*

Size (mm)	Colour	Finish	Code	Cost ex VAT	Cost inc VAT
RECTANGLE					
1000 x 800	White	Matt	IA108*	£525.36	£630.43
1000 x 800	White	Gloss	IAG108	£561.85	£674.22
1200 x 800	White	Matt	IA128*	£591.04	£709.25
1200 x 800	White	Gloss	IAG128	£627.51	£753.01
1200 x 900	White	Matt	IA129*	£612.93	£735.52
1200 x 900	White	Gloss	IAG129	£649.40	£779.28
1400 x 900	White	Matt	IA149*	£678.59	£814.31
1400 x 900	White	Gloss	IAG149	£715.07	£858.08
1600 x 800	White	Matt	IA168*	£700.48	£840.58
1600 x 800	White	Gloss	IAG168	£736.96	£884.35
1700 x 800	White	Matt	IA178*	£729.83	£875.80
1700 x 800	White	Gloss	IAG178	£766.31	£919.57
QUADRANT					
900 x 900	White	Matt	IA9Q*	£503.48	£604.18
900 x 900	White	Gloss	IAG9Q	£539.96	£647.95

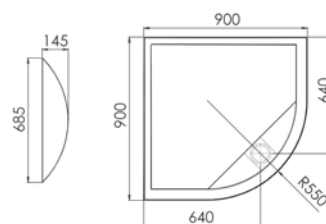

900 x 900mm
Quadrant

Neo Angle Trays

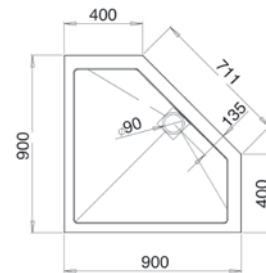

DNT9

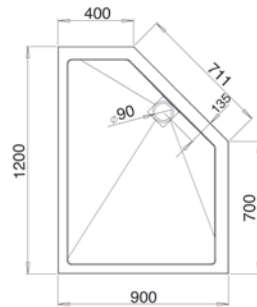

DNT129 Right Hand

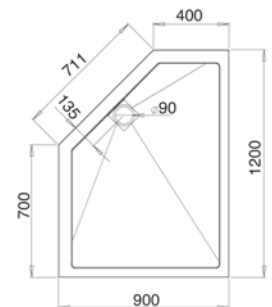

DNT129 Left Hand

Features and Benefits

Ultra low profile 40mm nominal height

Gloss or Matt* finish available in white

Manufactured using Roman Stone Solid Surface Technology

Anti-Slip options*

Size (mm)	Tray Colour	Finish	Code	Cost ex VAT	Cost inc VAT
900	White	Matt	DNT9*	£451.92	£542.30
900	White	Gloss	DNTG9	£487.24	£584.69
1200 x 900 LH	White	Matt	DNT129L*	£557.86	£669.43
1200 x 900 LH	White	Gloss	DNTG129L	£593.15	£711.78
1200 x 900 RH	White	Matt	DNT129R*	£557.86	£669.43
1200 x 900 RH	White	Gloss	DNTG129R	£593.15	£711.78

“ 25 litres per minute drainage ”



Anti Slip Trays

Matt Trays have been tested to:

BS7976-2:2002+A1:2013 – Slip potential – low DIN 51097:1992 Class C



Features and Benefits

- Ultra low profile
- 50mm nominal height
- Roman Stone Solid Surface Technology
- Gloss gel coated surface and matt satin options
- Includes chrome grid waste and fast flow trap
- Suitable for use with power shower systems rated up to 25 litres per minute

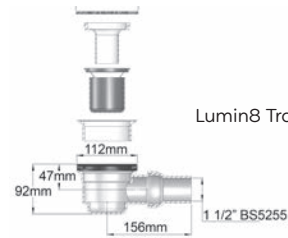

Lumin8 Tray Waste Dimensions



Anti Slip Trays
Matt Trays have been tested to:
BS7976-2:2002+A1:2013 - Slip potential - low DIN 51097:1992 Class C

Lumin8

Colossus Tray

(see pages 80 - 81 for Lumin8 Colossus details)

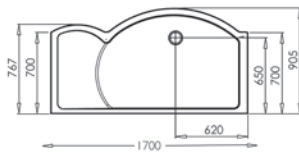

Left Hand - FC1L

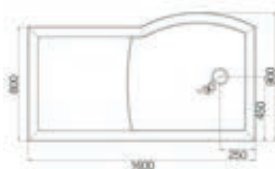

Left Hand V8GT

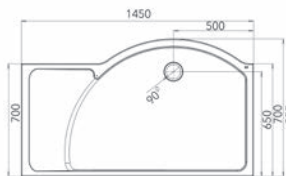

Left Hand FCT1L

All Lumin8 Trays are right or left handed depending upon requirements.
Please ensure you order the correct code for the handing required.

LH = Left Hand RH = Right Hand

Anti-Slip options*

Lumin8 1700 Colossus Tray

Size (mm)	Tray Colour	Finish	Code	Cost ex VAT	Cost inc VAT
1700 x 700 LH	White	Matt	FC1L*	£748.75	£898.50
1700 x 700 RH	White	Matt	FC1R*	£748.75	£898.50
1700 x 700 LH	White	Gloss	FCG1L	£784.40	£941.28
1700 x 700 RH	White	Gloss	FCG1R	£784.40	£941.28

Lumin8 1600 Colossus Tray

Size (mm)	Tray Colour	Finish	Code	Cost ex VAT	Cost inc VAT
1600 x 800 LH	White	Matt	V8GTLW*	£748.75	£898.50
1600 x 800 LH	Grey	Matt	V8GTLG*	£748.75	£898.50
1600 x 800 RH	White	Matt	V8GTRW*	£748.75	£898.50
1600 x 800 RH	Grey	Matt	V8GTRG*	£748.75	£898.50

Lumin8 1450 Colossus Tray

Size (mm)	Tray Colour	Finish	Code	Cost ex VAT	Cost inc VAT
1450 x 700 LH	White	Matt	FCT1L*	£727.36	£872.83
1450 x 700 RH	White	Matt	FCT1R*	£727.36	£872.83
1450 x 700 LH	White	Gloss	FCTG1L	£763.00	£915.60
1450 x 700 RH	White	Gloss	FCTG1R	£763.00	£915.60

Lumin8

Curved Panel Tray

(see pages 82 - 83 for Lumin8 Curved Wetroom Panel details)

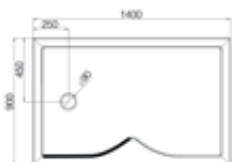

Left Hand - V8HTL

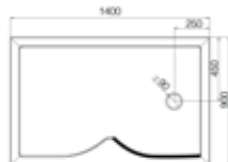

Right Hand - V8HTR

Size (mm)	Tray Colour	Finish	Code	Cost ex VAT	Cost inc VAT
1400 x 900 LH	White	Matt	V8HTLW*	£727.36	£872.83
1400 x 900 RH	Grey	Matt	V8HTLG*	£727.36	£872.83
1400 x 900 LH	White	Matt	V8HTRW*	£727.36	£872.83
1400 x 900 RH	Grey	Matt	V8HTRG*	£727.36	£872.83

Roman Trays

Acrylic Capped Stone

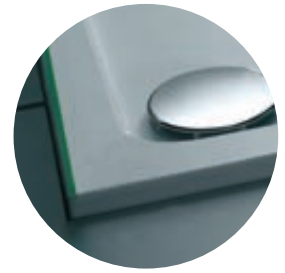

Chrome plated domed waste

Features and Benefits

- ~~~~~
- Low profile - only 40mm in height
- ~~~~~
- Available with optional leg kits to create raised version
- ~~~~~
- Manufactured using Roman Stone Solid Surface Technology
- ~~~~~
- Gloss finish
- ~~~~~
- Height of panel kits 95mm
- ~~~~~
- 90mm Domed Waste included
- ~~~~~



Square

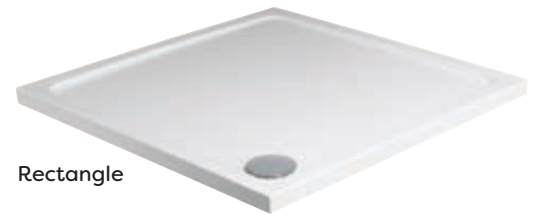

Rectangle



The power shower approved, easy clean, 90mm rapid drain outlet works with the sleek lines of the tray, allowing up to 32 litres of water to be carried away per minute. Manufactured from composite resin capped acrylic it is easy to install as it offers the option of flat to floor or raised on legs installation.

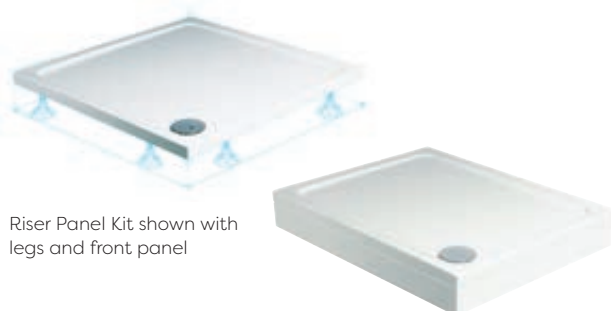
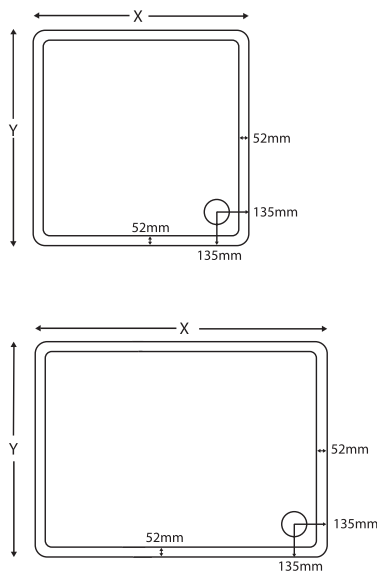

Riser Panel Kit shown with legs and front panel

Size (mm) X	Size (mm) Y	Tray Code	Optional Riser Kit Code	Cost ex VAT	Cost inc VAT
Roman Square Tray					
760mm	x 760mm	RLT76	RTPK03	£170.37	£204.44
800mm	x 800mm	RLT80	RTPK03	£197.17	£236.60
900mm	x 900mm	RLT90	RTPK03	£268.15	£321.78
1000mm	x 1000mm	RLT100	RTPK04	£425.87	£511.04
Roman Rectangle Tray					
900mm	x 760mm	RLT79	RTPK03	£283.91	£340.69
1000mm	x 760mm	RLT107	RTPK03	£291.80	£350.16
1000mm	x 800mm	RLT108	RTPK03	£315.48	£378.58
1000mm	x 900mm	RLT109	RTPK03	£323.35	£388.02
1100mm	x 800mm	RLT118	RTPK03	£323.35	£388.02
1100mm	x 900mm	RLT119	RTPK03	£323.35	£388.02
1200mm	x 760mm	RLT127	RTPK03	£307.58	£369.10
1200mm	x 800mm	RLT128	RTPK03	£307.58	£369.10
1200mm	x 900mm	RLT129	RTPK03	£347.02	£416.42
1400mm	x 900mm	RLT149	RTPK04	£496.87	£596.24
1500mm	x 800mm	RLT158	RTPK04	£559.95	£671.94
1600mm	x 800mm	RLT168	RTPK04	£615.16	£738.19
1700mm	x 800mm	RLT178	RTPK04	£646.72	£776.06
1800mm	x 800mm	RLT188	RTPK04	£709.98	£851.98
Riser Kits and Waste					
1200mm Square / Rectangle Panel Kit + feet			RTPK03	£118.30	£141.96
1800mm Rectangle Panel Kit + feet			RTPK04	£118.30	£141.96
Roman Tray Waste (90mm)			RTW	£47.33	£56.80



Quadrant

Size (mm) X	Size (mm) Y	Tray Code	Optional Riser Kit Code	Cost ex VAT	Cost inc VAT
Roman Quadrant Tray					
800mm	x 800mm	RLQ80	RTPK01	£244.49	£293.39
900mm	x 800mm LH	RLQ89L*	RTPK01	£299.70	£359.64
900mm	x 800mm RH	RLQ89R*	RTPK01	£299.70	£359.64
900mm	x 900mm	RLQ90	RTPK01	£299.70	£359.64
900mm	x 760mm LH	RLQ976L*	RTPK02	£339.12	£406.94
900mm	x 760mm RH	RLQ976R*	RTPK02	£339.12	£406.94
1000mm	x 1000mm	RLQ100	RTPK01	£362.78	£435.34
1000mm	x 800mm LH	RLQ108L*	RTPK02	£386.45	£463.74
1000mm	x 800mm RH	RLQ108R*	RTPK02	£386.45	£463.74
1200mm	x 800mm LH	RLQ128L*	RTPK02	£481.09	£577.31
1200mm	x 800mm RH	RLQ128R*	RTPK02	£481.09	£577.31
1200mm	x 900mm LH	RLQ129L*	RTPK02	£481.09	£577.31
1200mm	x 900mm RH	RLQ129R*	RTPK02	£481.09	£577.31
Riser Kits and Waste				Cost ex VAT	Cost inc VAT
Quadrant Panel Kit + feet			RTPK01	£118.30	£141.96
Off Set Quadrant Panel Kit + feet			RTPK02	£118.30	£141.96
Roman Tray Waste (90mm)			RTW	£47.33	£56.80

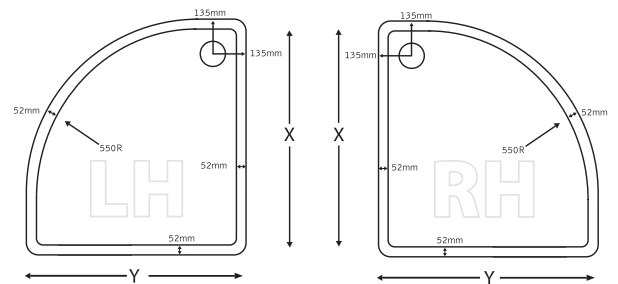
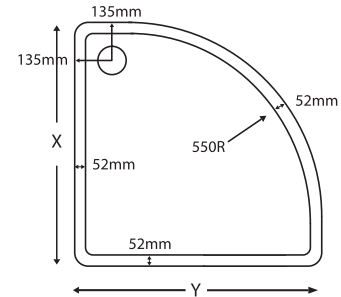

* Left or right handing must be specified

Anti-Slip Kit by Roman

Anti Slip Advantages

- Added reassurance in wet showers
- Easy to apply - after tray installation
- Hygienic and low maintenance
- Resilient and durable
- Solvent free
- Colourless

Possible Areas of Use:

- Shower trays
- Retirement homes and nursing homes
- Clinics and rehabilitation facilities

Only for use with Roman Acrylic Capped Stone Trays



Description	Code	Cost ex VAT	Cost inc VAT
Anti Slip Coating Pack	RTAS01	£110.42	£132.50



Outward Opening

Liberty Hinged Bath Screen
with Matt Black finish KLB13B

Features and Benefits

GLASS THICKNESS 10 Millimetres	GLASS THICKNESS 8 Millimetres	TOTAL HEIGHT 1500 Millimetres	REVERSIBLE	GLASS PROTECTION ULTRA CARE BY BIRMAN	TRULIFE LIFETIME GUARANTEE
---	--	--	-------------------	--	--------------------------------------

- Hinged from wall
- New clear and minimal seals
- Choice of colour finishes for hardware
- Designed for installation to straight vertical walls
- Optional brace bar included

Colour options for hardware:



- Matt Black**
add B
to codes
- Chrome**
add S
to codes
- Brushed Nickel**
add N
to codes
- Polished Nickel**
add PN
to codes
- Brushed Brass**
add BR
to codes

Glass (mm)	Height (mm)	Width (mm)	Adjustment (mm)	Code	Cost ex VAT	Cost inc VAT
8	1500	805	N/A	KLB13	£746.27	£895.52
10	1500	805	N/A	TLB13	£829.20	£995.04

Liberty
Hinged In-Line Bath Screen



Outward Opening

Liberty outward opening Hinged Bath Screen
with Brushed Brass finish KLBV13BR



Features and Benefits

GLASS THICKNESS 10 <small>Millimetres</small>	GLASS THICKNESS 8 <small>Millimetres</small>	TOTAL HEIGHT 1500 <small>Millimetres</small>	REVERSIBLE 	GLASS PROTECTION ULTRA CARE <small>BY B&B</small>	TRUELIFE LIFETIME GUARANTEE
---	--	--	-----------------------	---	--

- ~~~~~
- Hinged from In-Line Panel
- ~~~~~
- New clear and minimal seals
- ~~~~~
- New minimal easy fix wall profile system
- ~~~~~
- Choice of colour finishes for hardware
- ~~~~~
- Designed for installation to straight vertical walls
- ~~~~~
- Optional brace bars included
- ~~~~~

Colour options for hardware:



- Matt Black**
add **B**
to codes
- Chrome**
add **S**
to codes
- Brushed Nickel**
add **N**
to codes
- Polished Nickel**
add **PN**
to codes
- Brushed Brass**
add **BR**
to codes

Glass (mm)	Height (mm)	Width (mm)	Adjustment (mm)	Code	Cost ex VAT	Cost inc VAT
8	1500	1011	998 - 1012	KLBV13	£829.20	£995.04
10	1500	1011	998 - 1012	TLBV13	£921.32	£1105.58

Liberty
Black Grid Bath Screen



Features and Benefits

GLASS THICKNESS 10 Millimetres	TOTAL HEIGHT 1500 Millimetres	REVERSIBLE 	GLASS PROTECTION ULTRA CARE - ROMAN	TRULIFE LIFETIME GUARANTEE
--	---	-----------------------	---	--

- ~ Matt Black Aluminium Hardware
- ~ Printed Black Grid design
- ~ New minimal easy fix wall profile system
- ~ Designed for installation to straight vertical walls
- ~ Optional brace bar included

Fixed Screen

Liberty Black Grid Bath Screen KLBSGPB
Black Grid Mirror MIRO3
Black Shower Basket RSB07B

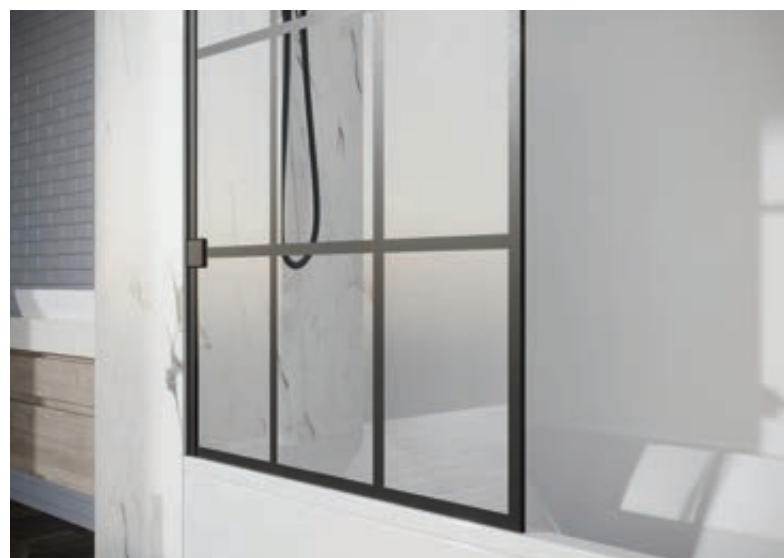
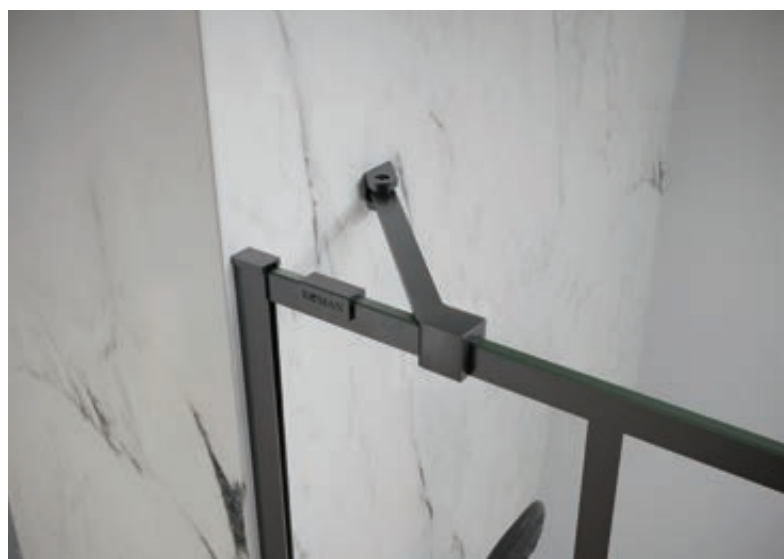

Glass (mm)	Height (mm)	Width (mm)	Adjustment (mm)	Code	Cost ex VAT	Cost inc VAT
10	1500	800	N/A	KLBSGPB	£678.98	£814.78

See page 118 for Black Grid Mirror information

Innov8
Hinged Bath Screen



Innov8 Frameless Folding Bath Screen N2BV213BL (left hand)

Outward Opening

“ Introducing the new matt black metal finish on this stunning hinged bath screen ”

Features and Benefits

GLASS THICKNESS
8
Millimetres

TOTAL HEIGHT
1500
Millimetres

GLASS PROTECTION
ULTRA CARE
BY SIBIAN

TRULIFE
LIFETIME GUARANTEE

Adjustment 890 - 910mm

Outward opening (hinges stop at 90° to avoid contact with basins and furniture)

Optional Bracing Bar included

Bath top aluminium seal for added water integrity

Power shower approved

Left or right handing must be specified



Innov8 Outward Folding Bath Screen N2BV213SL

Left Hand illustration

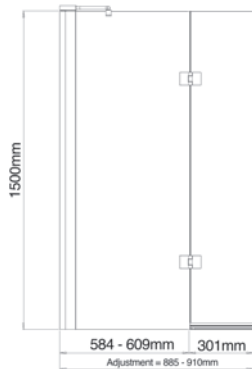

Please note this outward opening panel stops at 90° to avoid colliding with any furniture - ideal for small compact bathrooms and hotel rooms



Colour options for hardware:

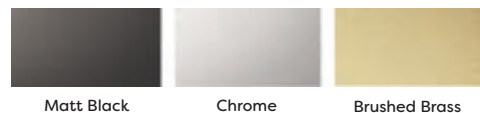

“ 8mm thick glass for a substantial finish and minimalist framing for a designer look ”

Description	Frame Colour	Handing	Width (mm)	Adjustment (mm)	Code	Cost ex VAT	Cost inc VAT
Outward Opening Bath Screen	Matt Black	Left Hand	910	890 - 910	N2BV213BL	£683.14	£819.77
Outward Opening Bath Screen	Matt Black	Right Hand	910	890 - 910	N2BV213BR	£683.14	£819.77
Outward Opening Bath Screen	Chrome	Left Hand	910	890 - 910	N2BV213SL	£683.14	£819.77
Outward Opening Bath Screen	Chrome	Right Hand	910	890 - 910	N2BV213SR	£683.14	£819.77
Outward Opening Bath Screen	Brushed Brass	Left Hand	910	890 - 910	N2BV213BRL	£683.14	£819.77
Outward Opening Bath Screen	Brushed Brass	Right Hand	910	890 - 910	N2BV213BRR	£683.14	£819.77

Please Note:
Brushed Brass finish availability Autumn 2022



Innov8 Black Framed Bath Screen NBF158B
Back to Wall Brace Kit NBBK4590SQB

“ A statement screen for a stylish contemporary bathroom ”

features and benefits

GLASS THICKNESS
8
Millimetres

TOTAL HEIGHT
1500
Millimetres

GLASS PROTECTION
ULTRA CARE
BY BIRMAN

TRUELIFE
LIFETIME
GUARANTEE

Adjustment 785 - 800mm

Fully framed matt black frame

Back to wall or ceiling brace options

Power shower approved



Innov8 Black Framed Bath Screen
with Fluted Glass NBF158FB
Ceiling Brace Kit NBBKC50SQB



Innov8 Black Framed Bath Screen NBF158B
Ceiling Brace Kit NBBKC50SQB

Description	Frame Colour	Glass	Width (mm)	Adjustment (mm)	Code	Cost ex VAT	Cost inc VAT
Framed Bath Screen	Matt Black	Clear	800	785 - 800	NBF158B	£520.00	£624.00
Framed Bath Screen	Matt Black	Fluted	800	785 - 800	NBF158FB	£750.00	£900.00

Square Brace Bars

Description	Colour	Size (mm) Max	Adjustment (mm) Min	Code	Cost ex VAT	Cost inc VAT
Back to Wall Brace Kit	Black	1030	Cut to suit	NBBK4590SQB	£147.65	£177.18
Ceiling Brace Kit	Black	1030	Cut to suit	NBBKC50SQB	£147.65	£177.18



Features and Benefits

GLASS THICKNESS 8 Millimetres	TOTAL HEIGHT 1500 Millimetres	GLASS PROTECTION ULTRA CARE - 99.99%	TRUELIFE LIFETIME GUARANTEE
---	---	--	--

- Frame: Silver or Black
- Vertical adjustment: 20mm
- Horizontal PVC seal and vertical magnetic seals
- Inward opening only
- Fixed panel and hinged screen
- Bath top aluminium seal for added water integrity
- Suitable for use with power showers
- Left or right handing must be specified



Innov8 Folding Bath Screen N2BV13SL
Shower Basket RSB05



Inward Folding

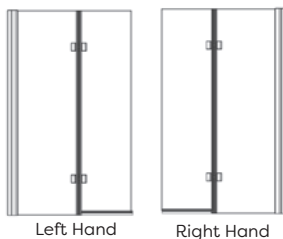

Left Hand

Right Hand

“ As used in top hotels all over the world ”

Description	Frame Colour	Handing	Width (mm)	Adjustments (mm)	Code	Cost ex VAT	Cost inc VAT
Inward Opening Bath Screen	Silver	Left Hand	900	880 - 900	N2BV13SL	£683.14	£819.77
Inward Opening Bath Screen	Silver	Right Hand	900	880 - 900	N2BV13SR	£683.14	£819.77
Inward Opening Bath Screen	Black	Left Hand	900	880 - 900	N2BV13BL	£683.14	£819.77
Inward Opening Bath Screen	Black	Right Hand	900	880 - 900	N2BV13BR	£683.14	£819.77



Features and Benefits

GLASS THICKNESS 8 Millimetres	TOTAL HEIGHT 1500 Millimetres	GLASS PROTECTION ULTRA CARE BY ROMAN	TRUELIFE LIFETIME GUARANTEE
--	--	---	--

- Chromed brass hinges
- Bright silver frame
- Power shower approved with unique seal system
- 25mm vertical adjustment in each profile
- Glass pre-coated with Roman Ultra Care
- V8B13S - reversible for left or right hand fixing
- V8BL13S - left or right handing must be specified

Designed to work around
existing fixtures and fittings



Inward or Outward
Opening

Lumin8 Frameless Bath Screen V8B13S
Shower Basket RSB06



Outward Opening

Lumin8 Frameless Hinged Bath Screen
V8BL13SR (right hand)
Shower Basket RSB06



Fixed Screen

Lumin8 Fixed Bath Screen V8BS13S
Shower Basket RSB06

Description	Width (mm)	Height (mm)	Wall Profile Colour	Glass	Adjustments (mm)	Code	Cost ex VAT	Cost inc VAT
Frameless Bath Screen	835	1500	Silver	Clear	810 - 835	V8B13S	£414.32	£497.18
Frameless Hinged Bath Screen	835	1500	Silver	Clear	810 - 835	V8BL13S*	£483.37	£580.04
Frameless Fixed Bath Screen	800	1467	Silver	Clear	783 - 808	V8BS13S	£326.43	£391.72
Frameless Fixed Bath Screen	800	1467	Black	Clear	783 - 808	V8BS13B	£326.43	£391.72

*Please indicate left or right handing when ordering e.g. V8BL13SL or V8BL13SR

Lumin8 Pivoting Bath Screen



Inward Opening

Lumin8 Inward Folding Bath Screen V8BV13B

Features and Benefits

GLASS THICKNESS 8 Millimetres	TOTAL HEIGHT 1500 Millimetres	REVERSIBLE 	GLASS PROTECTION ULTRA CARE BY BIRMAN	TRUELIFE LIFETIME GUARANTEE
---	---	-----------------------	---	--

Bright silver or Matt Black frame

25mm vertical adjustment in each profile



Lumin8 Inward Folding Bath Screen V8BV13S

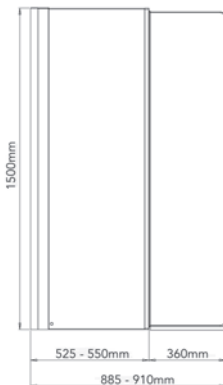

“ Its discreet inward folding panel ensures it avoids contact with all existing bathroom furniture ”

Description	Width Open (mm)	Width Closed (mm)	Adjustments (mm)	Code	Cost ex VAT	Cost inc VAT
Chrome Frame	885 - 910	525 - 550	885 - 910	V8BV13S	£445.69	£534.83
Black Frame	885 - 910	525 - 550	885 - 910	V8BV13B	£445.69	£534.83

Embrace Bath Screens



Embrace Chrome Bath Screen EB13S
Shower Basket RSB02

Inward or Outward Opening



Fixed Screen

Embrace Fixed Bath Screen EBS13S
Shower Basket RSB04



Inward or Outward Opening

Embrace Black Grid Bath Screen EBGPB
Shower Basket, RSB04

Features and Benefits



Frame: Silver or Matt Black

Unique sealing system between vertical and horizontal aluminium

Suitable for use with power showers



Embrace Matt Black Bath Screen EB13B
Shower Basket RSB02

Description	Width (mm)	Height (mm)	Glass	Frame Colour	Adjustments (mm)	Code	Cost ex VAT	Cost inc VAT
Standard Screen	820	1500	Clear	Chrome	810 - 835	EB13S	£354.46	£425.35
Standard Screen	820	1500	Clear	Matt Black	810 - 835	EB13B	£354.46	£425.35
Fixed Bath Screen	800	1467	Clear	Chrome	787 - 812	EBS13S	£276.20	£331.44
Black Grid Screen	820	1500	Black Grid	Matt Black	810-835	EBGPB	£400.00	£480.00

Embrace Folding Bath Screen



Embrace Inward folding
Bath Screen EBV213S

Inward Opening

Features and Benefits

GLASS THICKNESS
6
Millimetres

TOTAL HEIGHT
1500
Millimetres

REVERSIBLE

GLASS PROTECTION
ULTRA CARE
BY BENJAMIN

TRUELIFE
LIFETIME GUARANTEE

Frame: Silver

Width: open 525 - 550mm/closed 885 - 910mm

Frameless with radius glass

Suitable for use with power showers

Optional brace bar included



“Perfect solution for over the bath showering”

Description	Width (mm)	Adjustments (mm)	Code	Total Cost ex VAT	Total Cost inc VAT
Inward Folding Screen	910	885 - 910	EBV213S	£377.21	£452.65

Jupiter Bath Screens



Jupiter Standard Bath Screen JBL13S



Jupiter Curved Bath Screen JB13S

Inward and Outward Opening

Features and Benefits

GLASS THICKNESS 5 Millimetres	TOTAL HEIGHT 1360 Millimetres	REVERSIBLE 	GLASS PROTECTION ULTRA CARE BY BIRMAN	TRULIFE LIFETIME GUARANTEE
--	--	-----------------------	--	---

- Suitable for all standard bath mixer and electric showers
- Not recommended for use with pumped or pressurised systems
- Colourless vertical and horizontal PVC seals
- Rotates through 180° for access
- Supplementary sealing kit available for added water integrity

Description	Width (mm)	Adjustments (mm)	Code	Cost ex VAT	Cost inc VAT
Standard	Silver	810 - 825	JBL13S	£179.57	£215.48
Curved	Silver	810 - 825	JB13S	£189.73	£227.68
Supplementary Sealing Kit	-	-	BSP001	£39.44	£47.33

Lumin8 Mini Fixed Bath Screen



Lumin8 Mini Fixed Screen with Curved Rail V8CC213S

Curved Rail

V8CC113S - The Mini-Fixed Screen complements an existing curtain rail installation and reduces splashing around the back of the curtain and water see page along the top end of the bath.

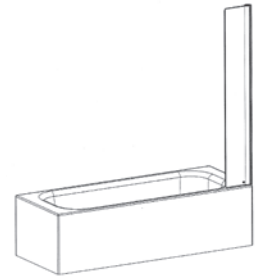

V8CC213S - The Mini-Fixed Screen complete with curtain rail (no curtain included) and wall attachments ensures a watertight shield to retain water in the bath. The curtain is held in place at the top and is less likely to allow water leakage out of the bath area. Rail length to suit 1700mm bath maximum.

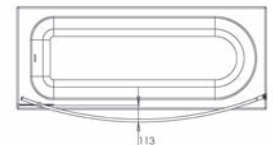

“ If you do it right, it will last forever. ”

- Massimo Vignelli

Features and Benefits



Frame: Silver

Suitable for all standard bath mixer and electric showers (non-pumped)

To be used in conjunction with shower curtains (no hooks or curtain supplied)

Curved rail to increase showering comfort with a curtain

Description	Adjustments (mm)	Code	Cost ex VAT	Cost inc VAT
Mini-Fixed Panel	243 - 257	V8CC113S	£202.46	£242.95
Mini-Fixed Panel with Curtain Rail	243 - 257	V8CC213S	£269.93	£323.92



“ Practical and stylish storage ”



RSB01

Double Hanging Basket with Hooks
Available Chrome or Matt Black

Spacers supplied so basket can be hung directly onto the glass edge

RSB01B



RSB02

Large Curved Corner Basket
available in Chrome or Black



RSB02B



RSB03

Chrome Stepped Soap Basket



RSB04

Chrome large 'L' Shaped Corner Basket





RSB05B



RSB05

Double Corner Basket with Hooks
Available Chrome or Matt Black



RSB06

Chrome large Rectangular Basket



RSB07

Double Rectangular 'single wall' Basket with Hooks
Available Chrome or Matt Black



RSB0100

Roman Shower Blade (includes spare blade part)
Available Chrome or Matt Black



RSB0100B

Description	Dimensions (mm)	Chrome Finish Code	Cost ex VAT	Cost inc VAT	Matt Black Finish Code	Cost ex VAT	Cost inc VAT
Double Hanging Basket with Hooks	D: 125mm W: 220mm H: 765mm	RSB01	£219.48	£263.38	RSB01B	£232.66	£279.19
Large Curved Corner Basket	D: 224mm W: 296mm H: 73mm	RSB02	£113.05	£135.66	RSB02B	£119.86	£143.83
Stepped Soap Basket	D: 131mm W: 260mm H: 57mm & 29mm	RSB03	£101.42	£121.70			
Large 'L' Shaped Corner Shower Basket	D: 115/125mm W: 255/270mm H: 99mm	RSB04	£147.99	£177.59			
Double Corner Shower Basket with Hooks	D: 224mm W: 293mm H: 399mm	RSB05	£191.22	£229.46	RSB05B	£202.69	£243.23
Large Rectangular Shower Basket	D: 120mm W: 260mm H: 95mm	RSB06	£113.05	£135.66			
Double Rectangular 'single wall' Shower Basket with Hooks	D: 106mm W: 215mm H: 391mm	RSB07	£154.64	£185.57	RSB07B	£163.91	£196.69
Roman Shower Blade (includes spare blade part)	-	RSB0100	£44.06	£52.87	RSB0100B	£46.71	£56.05

Black Grid Mirrors



Our bold industrial style window mirrors will make a statement in any room. These mirrors encapsulate factory chic with an elegant twist presenting a fabulous accent for the industrial trend. The mirrors feature printed glass and are suitable to be used in any room including bathrooms. The mirrors are made with 6mm safety glass.

Cleaning and care guidance:

Treat them like any other mirrored surface, use a lint free cloth and a purposely manufactured cleaning agent, designed for mirrors. Don't use anything abrasive.



Description	Size (mm)	Code	Cost ex VAT	Cost inc VAT
Square Black Grid Mirror	950 x 950mm	MIR01	£169.05	£202.86
Arched Black Grid Mirror	1100 x 750mm	MIR02	£197.20	£236.64
Square Black Grid Mirror	800 x 600mm	MIR03	£142.52	£171.02
Square Black Grid Mirror	700 x 500mm	MIR04	£130.59	£156.71

Glass Protection

“ The ultimate Bathroom Protector on glass ”

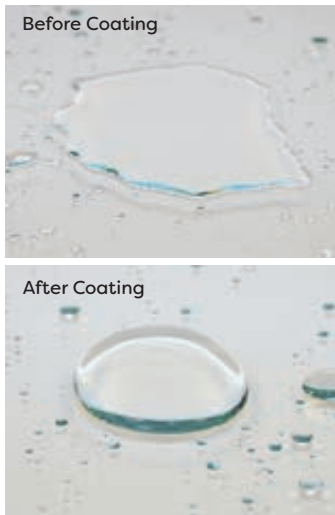

All Roman's enclosures and bath screens are pre-coated with Roman Ultra Care, our own unique glass protection system. Pre-coated glass protection systems will always diminish in their effectiveness over time, depending on how often the shower is used and how often it is cleaned. Unlike other systems, Roman Ultra Care in a bottle can be used in tandem with the pre-coat to build up the effectiveness and make it stronger the more you clean. Roman Ultra Care is an award winning bathroom protector and has a 15 year track record for successfully protecting Roman's extensive product range. When applied to the glass of an enclosure or bath screen it creates a chemical barrier which provides protection against the build-up of grime, limescale and stains. The protective barrier means water glides off the glass with ease. This results in the protected surface remaining easy to clean by simply applying a mild detergent and wiping with a damp cloth or using a Roman Shower Blade. By topping up the glass protection system with Roman Ultra Care in a bottle every time you clean, you can significantly reduce the amount of time required to clean your enclosure and bathroom surfaces. Most importantly, you can considerably prolong the life of your Roman product and at the same time do your bit for the environment by eliminating the use of harsh and damaging cleaning products.

RUC03 - 750ml Bottle Code

Buy online at www.romanathome.com

Make cleaning your bathroom easy with our

Shower, Tile and Bath Restoration and Maintenance Kit



RUC14 - Kit code

3 Step System includes:



Ultra Scrub
Surface Stain Cleanser
Designed to effectively and easily clean your bathroom surfaces, including Glass, Porcelain, Ceramics and other hard surfaces. Developed to remove the build-up of minerals, rust, soaps, oils and limescale but without damaging the surface.



Ultra Shield
Glass and Surface Stain Cleanser
Formulated to clean and protect. Ultra Shield can be used on your bathroom surfaces to create a water, soil and stain repellent barrier coating which prevents water, soil and grime from sticking for easier cleaning. This barrier is renewed with each use.



Ultra Care
Glass and Surface Protector
For a long lasting sparkle on bathroom and shower surfaces. Ultra Care is the ultimate surface protector that repels the build-up. Also available in large bottle for ongoing aftercare.

Restore discoloured glass and maintain the sparkle of your bathroom

Clean and protect your shower in minutes

Eliminates hard water and soap scum build-up

For details of your nearest stockist please contact Roman Customer Relations on 01325 328033 or buy online at www.romanathome.com

Environmental Objectives

“ Sustainable development is development which meets the needs of the present without compromising the ability of future generations to meet their own needs ”

The Brundtland Commission,
Our Common Future 1987



Roman has a huge commitment throughout the business to environmental targets, recycling, sustainable materials and sustainable business practices. As British manufacturers, Roman are increasingly focussed on environmental credentials and have a strong focus on the Circular Economy - with the ultimate aim of becoming carbon neutral. Every piece of aluminium is already 100% recycled before use, and all packaging is 100% recyclable before and after use. The benefit of working with solid surface material is any waste can be reground into the original material.

Roman has three core environmental objectives:

1. Reduce energy consumed as a direct proportion of business activity.
2. Increase the proportion of recycled waste.
3. Reduce and if possible eliminate any harmful emissions, discharges or pollutants generated by the business activity.

Roman is constantly working with our suppliers to maximise the use of recycled materials. The principles of the circular economy are embedded in all of our design and purchasing policies and plans. All Roman's aluminium and packaging is manufactured using 100% recycled material before we use it in our manufacturing process. All other materials used in the manufacturing of our products are also at high levels of recycled material. Our packaging is fully environmentally friendly with no wood or polystyrene used and is therefore itself 100% recyclable.



93% OF ALL WASTE IS RECYCLED

LANDFILL REDUCED **7%** OF TOTAL WASTE GENERATED

ALL WASTE IS SEGREGATED INTO RECYCLABLES & NON-RECYCLABLES



* Manufacturing Headquarters,
Durham

We worked with the Carbon Trust during 2021 in accordance with ISO 14064-3, and we are incredibly proud Roman met the requirements under PAS 2060 after our emissions and operations at our headquarters in County Durham were certified as carbon neutral.

www.carbontrust.com



We are a Participant of the United Nations Global Compact, a call to companies everywhere to align their strategies and operations with Ten Principles in the areas of human rights, labour, environment, and anti-corruption.

www.unglobalcompact.org



We were delighted to win the 'Circular Economy Award' at the Bathroom Manufacturers Association's inaugural Sustainability Awards on the 23rd November 2021, which recognises Roman's continued efforts to make an impact and improve sustainability.

www.bathroom-association.org.uk



We are proud to support the #TerraCarta from HRH The Prince of Wales' Sustainable Markets Initiative.

The Terra Carta provides a roadmap to 2030 for businesses to move towards an ambitious and sustainable future; one that will harness the power of Nature combined with the transformative power, innovation and resources of the private sector.

The global business proposition outlines ten areas for action and comprises of nearly 100 actions for business as the basis of a recovery plan that puts Nature, People and Planet at the heart of global value creation.

Find out more at: www.sustainable-markets.org/terra-carta



Company Vehicles are being updated to Hybrid or full electric (CO₂ emissions between 0-49 kgs per km) throughout the course of the next 2 years. All other vehicles are Euro 6 compliant.

Within our company car fleet we have 7 Hybrid vehicles and one full electric, we have invested heavily in electric point charging at our head office.

Overall company CO₂ reduction since 2016 is 40%.



EMS 523823

Roman Ltd Environmental Plan has reached all required business environmental management plans to achieve 14001 certification



This brochure is printed on material made from well-managed, FSC®-certified forests and other controlled sources.

Recycling your product

Packaging

As an ISO14001 Registered Company, Roman takes recycling very seriously at all levels. All cardboard is already manufactured from recycled paper, but our packaging itself is designed for recycling. Please ensure that the cardboard packaging is taken to a local cardboard recycling point or to a local recycling depot.

End of Life (EOL)

EOL recycling is taken into account from the initial design stages to ensure all aspects of the Roman products can be recycled for future use. The Aluminium, Brass Alloys, Glass (and Solid Surface Material with Roman Stone Trays) can be easily recycled at your local Licensed Recycling Centre (LRC). If you are unable to access an LRC, then Roman can arrange to coordinate a pick-up of your product for a modest transport charge.

Roman's Bespoke Service allows you to build a made to measure shower enclosure, wetroom panel or bath screen, to perfectly suit your available space.

Roman offers a Bespoke Service on many of our products. So if you are looking to install a shower enclosure into an awkward or unusual space, we have the perfect solution. Roman's Bespoke Service allows you to tailor the height and width of your product, we have the option of clear, frosted or printed glass. Glass can be cut at an angle or shaped, for example angled glass can allow for a sloping roof, to make adding a showering facility to a loft conversion or under your stairs, easy.



Innov8 Pivot Door with bespoke frosted glass adding privacy to your showering experience

- Made to measure items which fit almost anywhere
- All products made in accordance with your own measurements
- We endeavour to provide fast and efficient answers to all your questions
- Cost effective solutions
- Many designs to suit all tastes
- Measure and fit service available

Bespoke Services available:

- Reduced height
- Reduced width
- Clear, frosted or printed glass
- Angled/Shaped glass

To order a Bespoke Service all you have to do is simply choose which product you would like, then follow these six easy steps:

1. Take your drawings to your nearest retailer who will fax them to Roman. For your nearest retailer contact Roman Customer Relations on 01325 328033 or visit www.roman-showers.com
2. Roman will then send a quotation to your retailer for them to discuss with you
3. If you are happy with this quotation Roman will produce a drawing to illustrate what your final product will look like. Note: Roman will make all drawings in accordance to your measurements and unless otherwise requested, an adjustment allowance will be included. Please specify your adjustment allowance prior to ordering.
4. Roman will then fax the drawing to your retailer who will pass this on to you. This drawing will be in the form of a fax back agreement for you to sign*.
5. Once Roman receives the agreement work will begin on your product.
6. You will receive your product within 5-6 weeks.

*Once this agreement is signed you will be liable for any changes should you cancel your order.

For full pricing details and ordering process please go to:

www.roman-showers.com/roman-customers/available-downloads/

Consumer Guide

Roman shower enclosures have been tested and fully conform to the scope and relevant characteristics of BS EN14428:2015 (Shower Enclosures - Functional requirements and test methods), to meet the requirements of the mandate given under the EU Construction Product Directive (89/106/EEC).

As a result of full compliance to the directive and harmonized standard; Roman shower enclosures carry the 'CE' mark and are accompanied by a declaration of performance. (Available to view on www.roman-showers.com)

The CE marking indicates Roman shower enclosures conform to all essential requirements of European health and safety and environmental protection legislation. The conformity is mandatory, and allows Roman products to be legally placed on the market anywhere in the European Economic Area.

As per government guidelines Roman are actively preparing to apply the new UK CA Mark for any newly manufactured products from the 1st January 2021.

The UKCA (UK Conformity Assessed) marking is a new UK product marking that will be used for goods being placed on the market in Great Britain (England, Wales and Scotland). It covers most goods which previously required the CE marking.

Please note: this will only apply to any new products manufactured from 1st January 2021, any products held in stock will still be able to display the CE mark.

Additionally all Roman trays fully conform to EN14527:2016.

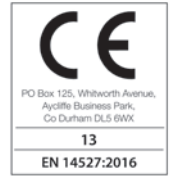

Important Product Details

- Enclosures and screens carry a Lifetime manufacturer's guarantee if products are installed according to the installation instructions - see guarantee criteria to the right.
- Simple and clear installation instructions are included with all Roman Products.
- Roman products are available for Virtual Worlds design service. For more information contact Roman Customer Relations on 01325 328033.
- Any guarantee variations are indicated separately.
- All guarantee forms supplied with installation instructions must be completed and returned to Roman within 60 days to validate the lifetime guarantee otherwise only a statutory 12 month guarantee will apply.
- All Roman Bath Screens and Enclosures are manufactured using toughened safety glass which complies to BSEN12150.
- All Roman Bath Screens and Enclosures are tested in accordance with BSEN14428 - shower enclosures, functional requirements and test methods.
- Roman's toughened glass is completely safe for use in our shower enclosures and both screens; providing our products are installed according to our guidelines.
- It is important to note, that the glass must not be mounted or 'pinched' in such a way that would cause a stress point to develop in the glass. In addition, it must not be subjected to any sharp impact or severe temperature fluctuation which may also cause a stress point to develop in the glass.
- Roman's toughened glass is physically and thermally significantly stronger than standard glass. However a significant impact (or stress as outlined above) can cause toughened glass to break. In the event of breakage, toughened glass will break safely into small fragments in line with all relevant standards.
- All heights quoted for enclosures and bath screens are from the top of the shower tray or bath.
- All fixings are hidden on Roman products.
- The term "Silver" and "Nickel" describes the colour of the aluminium finish. No silver metal is included in any Roman products.
- All fixings and pivot pins are manufactured from stainless steel - this adds great strength and durability to Roman products.
- All seals and gaskets on Roman products are manufactured from colourless PVC.
- Roman over-bath products are not designed for baths with shaped or stepped fronts or integral soap dishes.
- The design rights of these products are owned by Roman Limited. All rights reserved.
- Roman recommends only the use of Roman Trays with Roman Shower Enclosures.
- For compatibility of Roman enclosures with steam generators please contact Roman Customer Relations for advice on 01325 328033.
- Where indicated that products are suitable for use with steam generators, this refers to the performance of the product components. We do not however suggest that the product will have complete steam integrity.
- Due to the nature of wetroom panel products, water integrity cannot be guaranteed. Please consult your installer.
- We make every effort to ensure that your product reaches you in perfect condition. However, please be advised that all toughened glass panels are not covered by our guarantee if installed incorrectly or are subject to misuse. Roman's toughened glass is physically and thermally stronger than standard glass. However any significant impact may cause the glass to shatter in as safe a manner as possible and in accordance with the British and European standard (BS EN14428).

Guarantee

Roman Ltd. guarantees all Shower Enclosures, Bath Screens and Roman Solid Surface Trays against faulty materials or manufacture for LIFE, provided they have been installed, used and maintained in accordance with our instructions. All Roman product guarantees must be completed and returned within 60 days of purchase to validate the relevant guarantee. Failure to meet this deadline will result in a statutory 1 year guarantee on all products.

Should a claim arise, Roman Ltd. Customer Relations will investigate the issue. As part of this investigation we request that the following conditions be satisfied:

1. Proof of purchase at the time of the claim.
2. The guarantee applies to the original purchaser only and is non transferable.
3. The product has been fitted/installed in accordance with Roman Ltd. fixing instructions, local bylaws and general good plumbing practice
4. The product has been maintained and cared for in accordance with our instructions (including regular and appropriate cleaning).

If in our opinion the product has been modified, misused, neglected, wilfully or accidentally damaged, we can accept no responsibility for failure. Roman Ltd. or its representatives must be given the opportunity to inspect the product in the installed condition. Callouts may be chargeable depending upon circumstances.

Should any products included in the Lifetime guarantee be used for Commercial use i.e. leisure clubs, schools, hospitals, student accommodation, hotels or residential homes, only a 5 year guarantee will be applicable. If in our opinion the product fails due to faulty materials or manufacture and that the conditions above have been met, Roman Ltd. will arrange for a specialist Roman Technical Sales Representative to repair or replace that item at our option.

Roman Ltd. believes in continuous improvement. If in our opinion the product has failed under the terms of the Guarantee and a replacement is offered but identical goods are no longer available, Roman Ltd. will endeavour to replace it with our nearest equivalent product. For countries outside of the UK and Republic of Ireland, where a product has failed due to faulty materials or manufacture, a replacement product or product part will be offered only. Should Roman Ltd. carry out work as a result of a claim but subsequently it is revealed that the product has been abused or improperly installed, we reserve the right to charge the customer for the expense incurred. The liability of Roman Ltd. is limited to the product supplied by Roman Ltd. and does not extend to consequential loss or damage arising from the defective product.

This Guarantee, which is effective for products purchased after February 1st 2006, states our entire liability and is offered to customers acquiring our products as consumers, not in the course of trade or business. Ex displays or products reinstalled from their original position are not covered under this guarantee.

Non glass or metallic parts (e.g. seals) are subject to normal wear and tear through usage and are therefore covered on all products for 1 year from installation.

Roman products not included in the Lifetime Guarantee are Roman Acrylic Trays which are covered for 1 year.

Roman Ultra Care pre-coat is not covered by this guarantee and it must be maintained by applying Ultra Care from a bottle on an ongoing basis. Commercial projects with specific guarantee requirements can be subject to negotiation and agreement on a project by project basis. Any such agreements must be confirmed in writing prior to product supply or commencement in project works.

This guarantee does not affect your statutory rights.

This guarantee is wholly applicable in the U.K. and Republic of Ireland - export conditions as indicated

Roman Ltd
Whitworth Avenue, Aycliffe Business Park,
County Durham, DL5 6YN
Tel: 01325 311318 Fax: 01325 319889
www.roman-showers.com

UK:

Roman Limited,
Whitworth Avenue,
Aycliffe Business Park,
County Durham,
DL5 6YN,
England, UK.

General Reception:

Phone +44 (0) 1325 311318

UK Customer Relations:

Tel: +44 (0) 1325 328033

Email: custserv@roman-showers.com

UK Sales:

Tel: +44 (0) 1325 328034

Email: orders@roman-showers.com

International Sales/Customer Relations:

Tel: +44 (0) 1325 327740

Email: international@roman-showers.com

ASIA PACIFIC:

Roman Asia Sdn Bhd (941603-k)
No.6, Jalan Olivin,
Taman Industri Sungai Purun,
43500 Semenyih,
Selangor, Darul Ehsan,
Malaysia

Asia Sales:

Tel: +60 (0) 3 8727 8816

Email: romanasia@roman-showers.com

A&D SHOWROOM ASIA:

Cosentino Centre Kuala Lumpur - Malaysia,
Jalan TSB 8,
Taman Industri Sungai Buloh,
47000 Petaling Jaya,
Selangor,
Malaysia

IRELAND:

W10F

Ladytown Business Park,
Naas,
County Kildare,
Ireland

Ireland Sales:

Tel: +353 (0) 45 408 118

Email: irelandsales@roman-showers.com

A&D SHOWROOM LONDON:

648 King's Road,
Chelsea,
London
SW6 2DU

www.roman-showers.com

